

Stratto

Lighting 23



Catálogo

2026



L82425 BN
 Material: Metal / PC
 Acabado: Negro y blanco
 A. Cable: 400 cm
 A. Total: 420 cm
 D. 125+105+85
 +65+45 cm
 240W LED Integrado

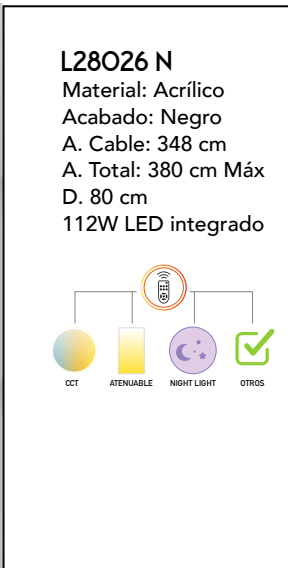
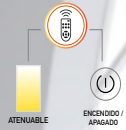

L28026 N
 Material: Acrílico
 Acabado: Negro
 A. Cable: 348 cm
 A. Total: 380 cm Máx
 D. 80 cm
 112W LED integrado

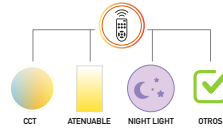

L82423 BN
 Material: Metal / PC
 Acabado: Negro y blanco
 A. Cable: 220 cm
 A. Total: 228 cm
 D. 85 + 65 + 45 cm
 105W LED Integrado

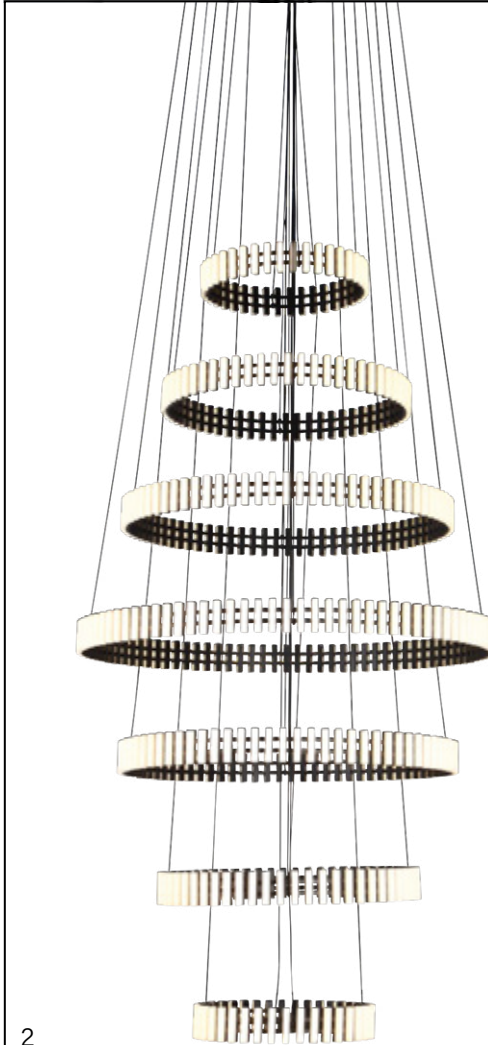

L82427 BN
 Material: Metal / PC
 Acabado: Negro y blanco
 A. Cable: 400 cm
 A. Total: 408 cm
 D. 105+85+65+45 cm
 300W LED Integrado



L28026 GD
 Material: Acrílico
 Acabado: Oro
 A. Cable: 348 cm
 A. Total: 380 cm
 D. 80 cm
 112W LED integrado.

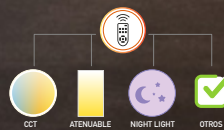

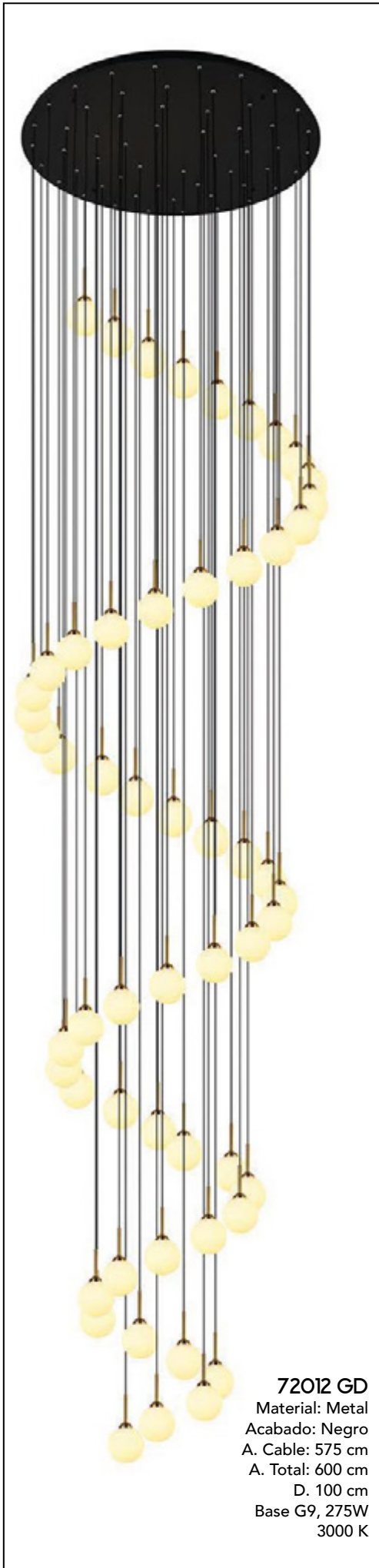

72012 GD
 Material: Metal
 Acabado: Negro
 A. Cable: 575 cm
 A. Total: 600 cm
 D. 100 cm
 Base G9, 275W
 3000 K

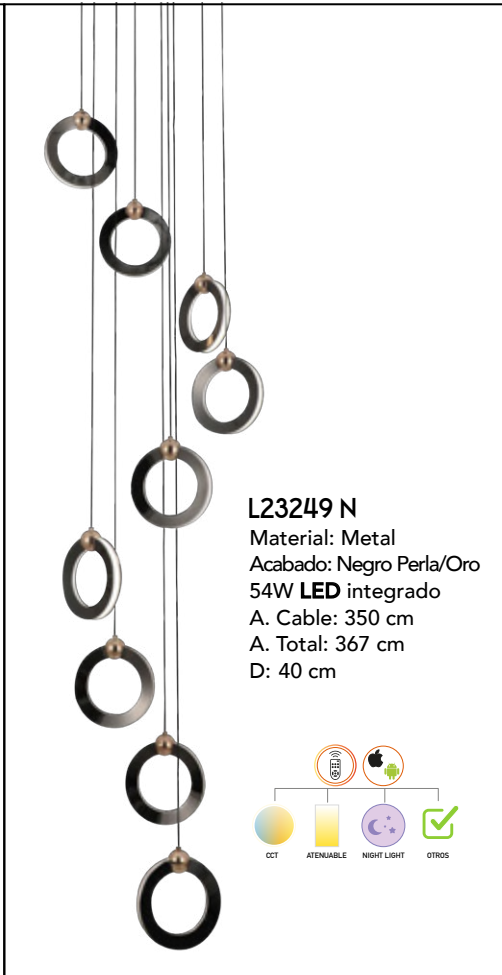

L23249 N
 Material: Metal
 Acabado: Negro Perla/Oro
 54W LED integrado
 A. Cable: 350 cm
 A. Total: 367 cm
 D: 40 cm

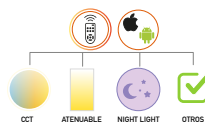

L232415 N
 Material: Metal
 Acabado: Negro Perla/Oro
 90W LED integrado
 A. Cable: 350 cm
 A. Total: 367 cm
 D: 50 cm



L77105 GD
 Material: Aluminio
 Acabado: Dorado
 A. Total: 300 cm
 D. 40+60+80+100+120 cm
 150W LED

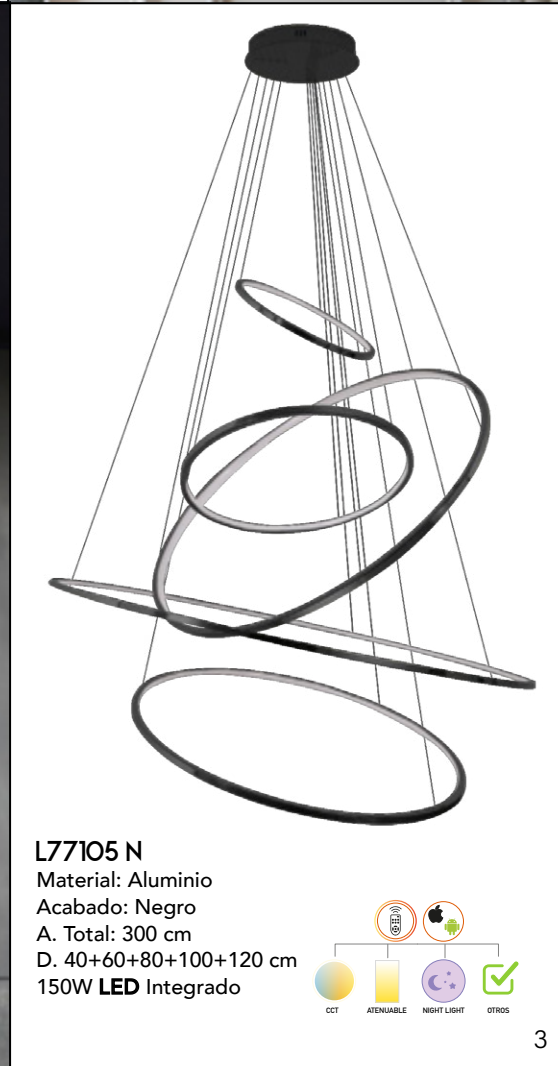

L77105 N
 Material: Aluminio
 Acabado: Negro
 A. Total: 300 cm
 D. 40+60+80+100+120 cm
 150W LED Integrado

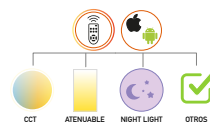



L23513 GD
 Material: Cristal
 Acabado: Oro
 A. Cable: 310 cm
 A. Total: 350 cm
 D. 60 cm
 40W LED Integrado

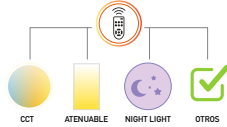

L23501 GD
 Material: Cristal
 Acabado: Oro
 A. 25 cm
 D. 12 cm
 3W LED Integrado
 3000 K



L23613 GD
 Material: Acrílico
 Acabado: French Gold
 A. Cable: 320 cm
 A. Total: 348 cm
 D. 60 cm
 78W LED Integrado

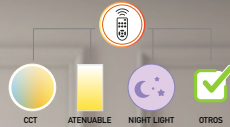

L23671 GD
 Material: Acrílico
 Acabado: French Gold
 A. 32 cm
 D. 6 cm
 6W LED Integrado
 3000 K



L76650 N
 Material: Aluminio
 Acabado: Dorado y Negro
 A. Cable: 230 cm
 A. Total: 250 cm
 D. 56 cm
 72W LED Integrado



L46652 N
 Material: Aluminio
 Acabado: Dorado y Negro
 A. 47 cm
 D. 12 cm
 12W LED Integrado
 3000K
 3 INTENSIDADES
 DE LUZ



L76655 N
 Material: Metal + Aluminio
 Acabado: Negro + Cobre
 A. Total: 230 cm
 D. 80 + 60 + 40 cm
 75W LED Integrado

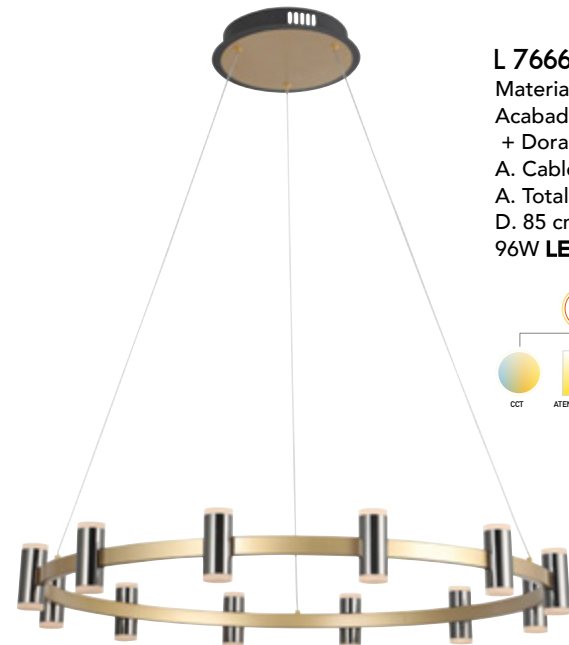

L76666 GD
 Material: Aluminio
 Acabado: Negro Arena + Dorado Mate
 A. Cable: 230 cm
 A. Total: 240 cm
 D. 85 cm
 96W LED Integrado

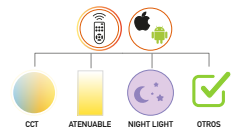



L60980 GD
 Material: Metal
 Acabado: Dorado
 A. Cable: 230 cm
 A. Total: 250 cm
 L. 150 cm
 80W LED Integrado



L60980 N
 Material: Metal
 Acabado: Negro
 A. Cable: 230 cm
 A. Total: 250 cm
 L. 150 cm
 80W LED Integrado

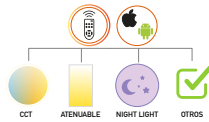

L90858 GD
 Material: Metal
 Acabado: Oro
 A. Cable: 225 cm
 A. Total: 250 cm
 L. 120 cm
 80W LED integrado

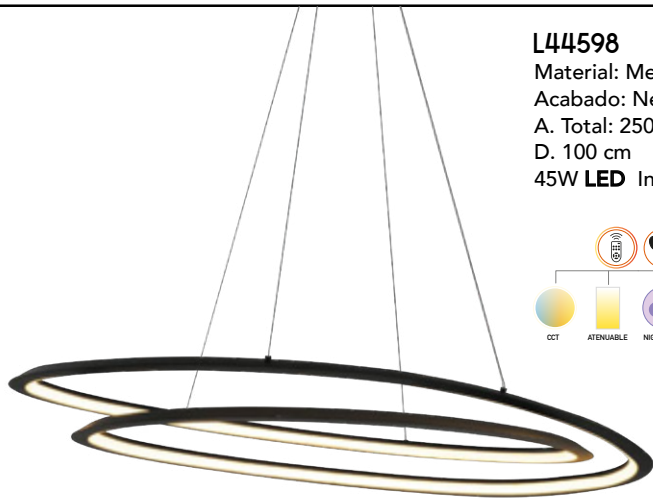

L44598
 Material: Metal
 Acabado: Negro
 A. Total: 250 cm
 D. 100 cm
 45W LED Integrado

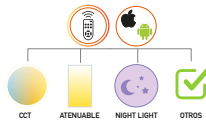

L48088 N
 Material: Aluminio + Acrílico
 Acabado: Negro
 A. Cable: 230 cm
 D. 80 cm
 A. Total: 250 cm
 45W LED Integrado

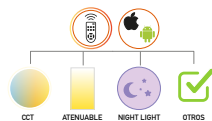

L41128 N
 Material: Acrílico
 Acabado: Negro Mate
 A. Cable: 250 cm
 A. Total: 284 cm
 D. 45 cm
 36W LED Integrado

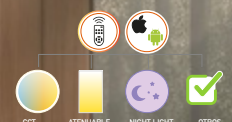

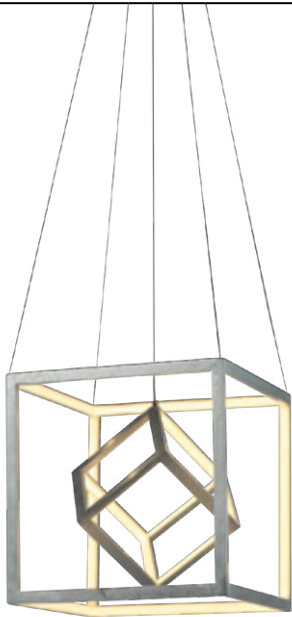

L49030 SL

Material: Acrílico
 Acabado: Lámina de Oro
 A. Cable: 130 cm
 A. Total: 160 cm
 D. 30 cm
 20W **LED** Integrado
 3000 K



L46050 FR

Material: Acrílico Mate
 Acabado: Cromo
 A. Cable: 136 cm
 A. Total: 186 cm
 D. 50 cm
 24W **LED** Integrado
 3000 K

440401

Material: Cristal
 Acabado: Cromo
 A. Cable: 90 cm
 A. Total: 120 cm
 D. 12 cm
 40W G9 Incluido



L23601 GD

Material: Acrílico
 Acabado: French Gold
 A. Cable: 220 cm
 A. Total: 248 cm
 D. 6 cm
 6W **LED** Integrado
 3000 K



L42320

Material: Cristal
 Acabado: Cromo
 A. Total: 120 cm
 D. 60 cm
 20W **LED** Integrado
 4000 K

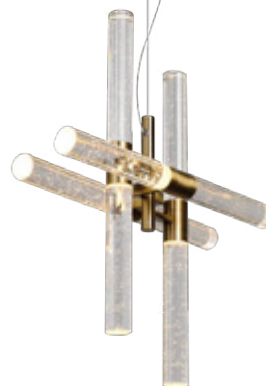

L48715 GD

Material: Metal + Cristal
 Acabado: Antique
 A. Cable: 210 cm
 A. Total: 250 cm
 D. 49 cm
 25W **LED** Integrado
 3000 K



L42061

Material: Metálica
 Acabado: Satín
 A. Cable: 200 cm
 A. Total: 250 cm
 D. 50 cm
 60W **LED** Integrado

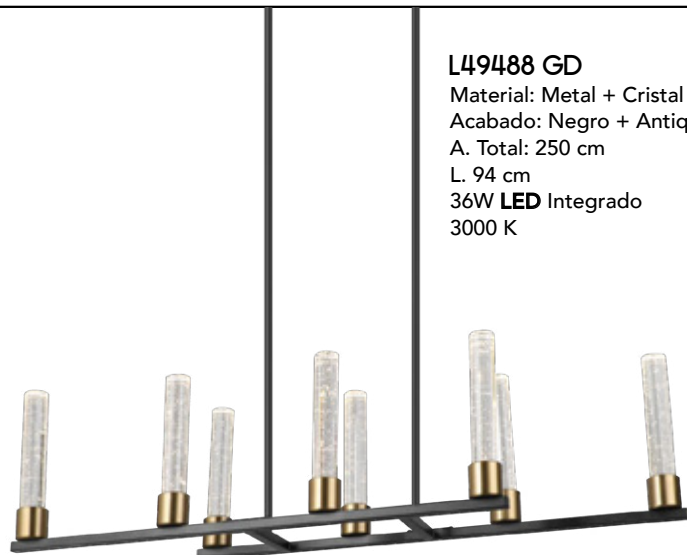

L49488 GD

Material: Metal + Cristal
 Acabado: Negro + Antique
 A. Total: 250 cm
 L. 94 cm
 36W **LED** Integrado
 3000 K





L48070 OL

Material: Metal
 Acabado: Lámina de Oro
 A. Cable: 230 cm
 A. Total: 260 cm
 D. 70 cm
 55W LED Integrado

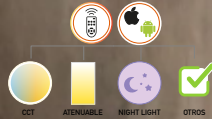

L48070 CH

Material: Metal
 Acabado: Lámina de Plata
 A. Cable: 230 cm
 A. Total: 260 cm
 D. 70 cm
 55W LED Integrado

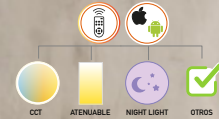

L43836 N

Material: Aluminio
 Acabado: Negro
 A. Cable: 230 cm
 A. Total: 250 cm
 L. 120 cm
 45W LED Integrado



L43836 GD

Material: Aluminio
 Acabado: Dorado
 A. Cable: 230 cm
 A. Total: 250 cm
 L. 120 cm
 45W LED Integrado



L48025 OL

Material: Metal
 Acabado: Lámina de Oro
 A. Cable: 160 cm
 A. Total: 180 cm
 D. 25 cm
 30W LED Integrado

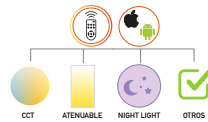

L48025 CH

Material: Metal
 Acabado: Lámina de Plata
 A. Cable: 160 cm
 A. Total: 180 cm
 D. 25 cm
 30W LED Integrado

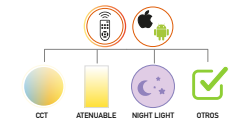

L78301

Material: Metal
 Acabado: Cromado
 A.: 13 cm
 D.: 13 cm
 4W LED Integrado



L78302

Material: Metal
 Acabado: Cromado
 L.: 32 cm
 A.: 15 cm
 2X4W LED Integrado



L48300

Material: Metal
 Acabado: Cromado
 A Total: 120 cm
 D.: 10 cm
 8W LED Integrado



L78711 GD
 Material: Metal
 + Cristal
 Acabado: Antique
 L. 12 cm
 A. 54 cm
 7W **LED** Integrado
 3000 K



L71123 GD
 Material: Metal + Cristal
 Acabado: Negro + Antique
 L. 48 cm
 A. 28 cm
 12W **LED** Integrado
 3000 K



L49422 GD
 Material: Metal + Cristal
 Acabado: Negro + Antique
 L. 30 cm
 A. 28 cm
 8W **LED** Integrado
 3000 K



L42301
 Material: Cristal
 Acabado: Cromo
 L. 33 cm
 A. 10 cm
 6W **LED** Integrado
 4000 K



L74510 CH
 Material: Acero Inoxidable
 Acabado: Cromo
 L. 16 cm
 A. 10 cm
 5W **LED** Integrado
 6500 K



L74522 CH
 Material: Acero Inoxidable
 Acabado: Cromo
 L. 34 cm
 A. 10 cm
 9W **LED** Integrado
 3000 K



L79911 GD
 Material: Cristal
 Acabado: Oro
 L. 11 cm
 A. 26cm
 5W **LED** Integrado
 3000K



L82411 BN
 Material: Metal
 Acabado: PC
 L. 30 cm
 A. 15 cm
 15W **LED** Integrado
 3000K



740401
 Material: Cristal
 Acabado: Cromo
 L. 12 cm
 A. 12 cm
 40W **LED** Integrado
 4000 K



740402
 Material: Cristal
 Acabado: Cromo
 L. 33 cm
 A. 12 cm
 2x40W **LED** Integrado
 4000 K



701052
 Material: Cristal + Metal
 Acabado: Cromo
 L. 30 cm
 A. 15 cm
 2x40W G9

441051
 Material: Cristal + Metal
 Acabado: Cromo
 L.: 15 cm
 A total.: 130 cm
 40W G9



L6900 S
 Material: Cristal Cromo
 Acabado: Satín
 D.: 15 cm
 A total.: 130 cm
 5W **LED** Integrado
 3000 K



L6900 B
 Material: Cristal Opalino
 Acabado: Satín
 D.: 15 cm
 A total.: 130 cm
 5W **LED** Integrado
 3000 K

Stratto Lighting by 2G es una marca de la familia

COMERCIAL 2/G
 BRIGHT SOLUTIONS

www.stratto2g.com

Arte en Iluminacion