

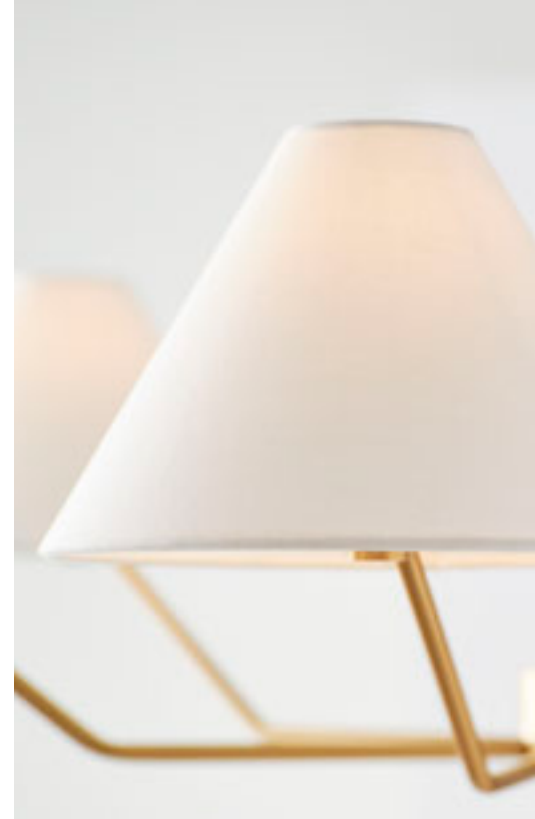

GENERATION LIGHTING



GENERATION LIGHTING



The Generation Lighting Collection is the continuation of generations of design experience serving the unique needs of builders and contractors, while appealing to homeowners and remodelers. Today, our wide assortment of indoor to outdoor lighting and ceiling fans offers timely and timeless looks at a compelling value. We're proud to bring over 100 years of lighting knowledge and legacy relationships to the world of popular design, making great style accessible to everyone.



CLASSIC / MODERN

Lighting is an important building element with a key central function. It also has the design flexibility to express the perfect style, from modern to classic. Our selection spans this full creative range, where each light has just the right amount of detail to be appropriate, impactful, and memorable.



CEILING / WALL

We appreciate fixtures that make a dramatic statement in context to their application and environment. From a focal point chandelier to decorative sconces, our ceiling and wall designs bring a whole room to life with light.



INDOOR / OUTDOOR

Interior design has moved outside for continuous indoor/outdoor living. We've responded with lights that work in harmony across both settings, favoring clean lines for easy assimilation with a variety of architectural styles.



DECORATIVE / FUNCTIONAL

Purposeful and affordable lighting doesn't have to be plain or generic. We bring a valuable decorative perspective together with practical function, in a variety of task lights for dedicated applications.

FAMILIES / FINISHES

We extend the range of favorite profiles by building lighting families around a key shape or detail. This allows for continuity and includes a variety of individual finishes, adding personalization for each fixture.



SINGLE / MULTIPLE

Using the same visual language in different ways increases the scope and choice in your design plan. A single fixture creates focus; or, use one form repeated, as a building block for a larger or more dramatic array.



UPLIGHT / DOWNLIGHT

Fixed lighting is all about the proper dedicated positioning of light where it is needed. We provide options, with many pieces designed to work dual ways—as a supporting layer of uplight or a more directed spot of downlight.



BEAUTIFUL / ECONOMICAL

Across this collection, we're devoted to producing lighting that is as striking as it is useful and economical. By design, every light is intended to create beautiful spaces of great value.



FEATURED DESIGNS



DREW & JONATHAN

Through their lighting collection, Drew and Jonathan Scott express the sense of home they have felt through every step of their journey—a reflection of their experiences, designed for yours. Their modern home furnishings and décor represent the guiding principles in all their work: Quality craftsmanship, inspirational design, and a desire to improve your everyday life. With casual and refined styles that seamlessly fit into your home, you can focus on what matters most: making memories of your own.

**drew &
jonathan™**



#visualcomfort

Get Inspired @VISUALCOMFORT

FINISH NAME & CODES

Aged Iron	[AI]	Matte Black	[MB]
Antique Bronze	[-71]	Midnight Black	[-112]
Antique Bronze	[ANBZ]	Midnight Black	[MBK]
Antique Brushed Nickel	[-965]	Mocha Bronze	[MBZ]
Antique Forged Iron	[AF]	Oil Rubbed Bronze	[ORB]
Antique Guild	[ADB]	Oxford Bronze	[-746]
Astral Bronze	[ASTB]	Oxidized Bronze	[-46]
Autumn Bronze	[-715]	Oxidized Bronze	[OZB]
Black	[-12]	Paintable Ceramic	[-714]
Black	[BK]	Painted Brushed Nickel	[-753]
Bronze	[-710]	Pewter	[-155]
Bronze (Outdoor)	[-10]	Pewter Bronze	[-778]
Brushed Nickel	[-962]	Polished Brass	[-02]
Brushed Stainless	[-98]	Polished Nickel	[PN]
Brushed Steel	[-BS]	Restoration Bronze	[RSZ]
Burled Iron	[-780]	Rustic Iron	[RI]
Burnished Bronze	[BB]	Satin Aluminum	[-04]
Chrome	[-05]	Satin Brass	[-848]
Chrome	[CH]	Satin Nickel	[-849]
Copper Oxide	[CO]	Satin Nickel	[SN]
Corinthian Bronze	[CB]	Slate Grey Metal	[SGM]
Dark Antique Brass	[DAB]	Stardust	[-846]
Dark Bronze	[DBZ]	Statuary Bronze	[-51]
Dark Weathered Iron	[DWI]	Tarnished Silver	[TRD]
Dark Weathered Zinc	[DWZ]	Textured Black	[TXD]
Driftwood	[DFW]	Washed Pine	[-872]
Espresso	[ES]	Weathered Copper	[-44]
Forged Iron	[-185]	Weathered Pewter	[-57]
Grecian Bronze	[GBZ]	White	[-15]

ICON LEGEND

ADA Compliant

Meets the 4" maximum extension requirement of the Americans with Disabilities Act.

Damp Rated

Safety listed for damp location.

Dark Sky

Has 180° light cut-off to minimize light pollution in the night sky.

ENERGY STAR® Qualified

Meets strict energy efficiency guidelines set by the EPA and Department of Energy.

Fluorescent Light Source

Has a fluorescent option.

Integrated LED Warm-On-Dim

LED fixture for which the color temperature warms as the fixture dims.

LED

Has integrated LED or has an LED option.

Mounting Options

These fixtures may: a) mount up or down, b) have a flush or semi-flush option, or c) have configuration options, such as movable heads or arms. Details are provided in the item description.

StoneStrong

Constructed with a unique synthetic composite engineered to withstand even the harshest environmental conditions, and backed by a 5-year warranty.

Title 24

Can be used to comply with California Energy Commission (CEC) 2016 Title 24 Part 6 High Efficacy LED Light Source Requirements if used with lamps (not included) that are registered and appear in the CEC Appliance Database.

Title 24

Can be used to comply with California Energy Commission (CEC) 2016 Title 24 Part 6 High Efficacy LED Light Source Requirements if used with included lamps that are registered and appear in the CEC Appliance Database.

Title 24

Can be used to comply with California Energy Commission (CEC) 2016 Title 24 Part 6 High Efficacy LED Light Source Requirements. These fixtures are registered and appear in the CEC Appliance Database.

Title 24

Can be used to comply with California Energy Commission (CEC) 2016 Title 24 Part 6 High Efficacy LED Light Source Requirements. These fixtures are not required to be registered with the CEC nor appear in the CEC Appliance Database (generally fluorescent and outdoor inseparable LED luminaires).

Wildlife Friendly Lighting

When used with lamp S9188, the amber LED @590nM complies with marine turtle safe lighting requirements within coastal regions.

Weighs Over 50 lbs.

This fixture weighs over 50 pounds and must be supported independently of outlet box.

Wet Rated

Safety listed for wet location.

THINGS TO NOTE

Light bulbs are not included with lighting fixture products shown in this catalog, unless otherwise noted. Generation Lighting reserves the right, at any time to make changes in the construction and design of products listed without notice. The changes may be necessary by law or the availability of supplies.

ENERGY STAR® is a registered trademark of the United States Environmental Protection Agency.

14	VISUAL INDEX
70	TABLE
	CEILING
84	CHANDELIERS
114	LINEAR
132	LANTERNS
144	HANGING SHADES
150	PENDANTS
182	FLUSH & SEMI-FLUSH
	WALL
198	WALL SCONCES
208	VANITY & MIRRORS
254	STEP & HALL LIGHTS
260	OUTDOOR
354	CEILING FANS
404	LIGHTING SYSTEMS
440	RECESSED
460	BUILDER SERIES
528	RESOURCES

CONTENTS

BINX

DREW & JONATHAN
p.76

- FINISHES | MATERIALS
- Satin Brass (SBI)
White Linen Fabric Shade
 - Midnight Black (MBK1)
White Linen Fabric Shade



Medium
Task Lamp

BUCKLEY

DREW & JONATHAN
p.78

- FINISHES | MATERIALS
- Gloss White (GW1) Satin Brass
White Linen Fabric Shade
 - Gloss Navy (GNV1) Satin Brass
White Linen Fabric Shade
 - Gloss Black (BK1) Satin Brass
White Linen Fabric Shade



Medium
Table Lamp

FERNWOOD

DREW & JONATHAN
p.82

- FINISHES | MATERIALS
- Matte White (MWT) Satin Brass
White Linen Fabric Shade
 - Navy (NVY) Satin Brass
White Linen Fabric Shade
 - Midnight Black (MBK) Satin Brass
White Linen Fabric Shade



Medium
Table Lamp

MORSEBY

DREW & JONATHAN
p.80

- FINISHES | MATERIALS
- Gloss White (GW1) Satin Brass
White Linen Fabric Shade
 - Gloss Navy (GNV1) Satin Brass
White Linen Fabric Shade
 - Gloss Black (BK1) Satin Brass
White Linen Fabric Shade



Medium
Table Lamp

PENDER

DREW & JONATHAN
p.72

- FINISHES | MATERIALS
- Satin Brass (SBI) Clear Glass
White Linen Fabric Shade
 - Midnight Black (MBK1) Clear Glass
White Linen Fabric Shade



Medium
Table Lamp

PORTEAU

DREW & JONATHAN

p.74

FINISHES | MATERIALS

- Satin Brass (SB)
White Linen Fabric Shade
- Midnight Black (MBK)
White Linen Fabric Shade



Medium
Table Lamp

ALTURAS

p.98

FINISHES | MATERIALS

- Midnight Black (-112) Opal Etched Glass or Clear Seeded Glass Shades
- Brushed Nickel (-962) Opal Etched Glass or Clear Seeded Glass Shades
- Satin Brass (-848) Opal Etched Glass or Clear Seeded Glass Shades

EN ★ DAMP T24-1 T24-2



Large
Nine Light
Chandelier

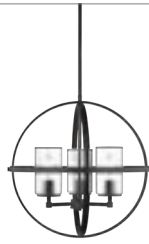

Medium
Five Light
Chandelier



Small
Three Light
Chandelier

ANSLEY

p.102

FINISH

- Aged Iron (AI)

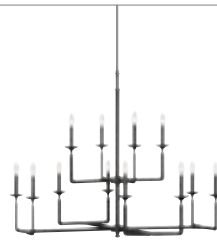

Large
Chandelier

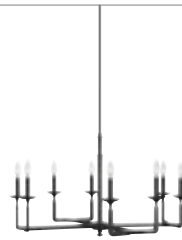

Medium
Chandelier

BURKE

DREW & JONATHAN

p.90

FINISHES | MATERIALS

- Brushed Steel (BS) White Linen Fabric Shades
- Satin Brass (SB) White Linen Fabric Shades
- Midnight Black (MBK) White Linen Fabric Shades

DAMP

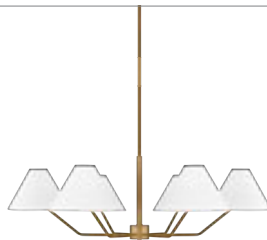

Large
Chandelier



Medium
Chandelier

CAPALINO

DREW & JONATHAN

p.86

FINISHES | MATERIALS

- Brushed Steel (BS) White Linen Fabric Shades
- Satin Brass (SB) White Linen Fabric Shades
- Midnight Black (MBK) White Linen Fabric Shades

DAMP

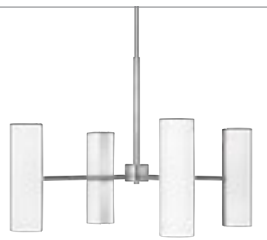

Large
Chandelier



Medium
Chandelier

CELESTE

p.104

FINISH

- Aged Iron/Antique Gild (AI/ADB)

DAMP



Large
Chandelier



Medium
Chandelier

CHATEAU

p.110

FINISH

■ Mocha Bronze (MBZ)



Extra Large Chandelier



Large Chandelier



Medium Chandelier



Small Chandelier

DRISCOLL

p.92

FINISHES | MATERIALS

■ Brushed Nickel (-962)
Opal Etched Glass

■ Satin Brass (-848)
Opal Etched Glass

EN ★ T24-1 T24-2



Medium Five Light Chandelier



Small Three Light Chandelier

EGMONT

DREW & JONATHAN

p.88

FINISHES | MATERIALS

■ Brushed Steel (BS)
White Linen Fabric Shades

■ Satin Brass (SB)
White Linen Fabric Shades

■ Midnight Black (MBK)
White Linen Fabric Shades

DAMP



Extra Large Chandelier



Large Chandelier

ETHAN

p.112

FINISH | MATERIALS

■ Antique Forged Iron/Brushed Steel (AF/
BS) Clear Glass



Extra Large Chandelier

HADDEN

DREW & JONATHAN

p.96

FINISHES | MATERIALS

■ Satin Brass (SB)

■ Midnight Black (MBK)

DAMP



Large Chandelier



Medium Chandelier



Small Chandelier

JONAH

p.107

FINISH | MATERIALS

Satin Nickel/Chrome (SN/CH)
White Opal Etched Glass



Large Two-Tier Chandelier



Medium Chandelier

LORAS

p.105

FINISH | MATERIAL

Dark Weathered Iron (DWI)
Clear Seeded Glass Shades

DAMP



Medium Chandelier

MARIELLE

p.108

FINISH

Antique Gild (ADB)

DAMP



Large Chandelier



Medium Chandelier

PORTEAU

DREW & JONATHAN

p.93

FINISHES | MATERIALS

Satin Brass (SB)
White Linen Fabric Shades

Midnight Black (MBK)
White Linen Fabric Shades

DAMP



Large Chandelier



Medium Chandelier

RAVENWOOD MANOR

p.106

FINISH

Stardust (~846)

DAMP T24-1



Large Nine Light Chandelier



Medium Five Light Chandelier

SOCORRO

p.113

FINISH

Stardust (-846)

DAMP T24-1



Extra Large
Six Light
Chandelier



Large
Six Light
Chandelier



Medium
Four Light
Chandelier

TOWNER

p.94

FINISHES | MATERIALS

Brushed Nickel (-962)
Midnight Black (-112) Shades
Satin Brass (-848)
Midnight Black (-112) Shades

EN* DAMP T24-1 T24-2



Large
Seven Light
Chandelier



Medium
Five Light
Chandelier



Small
Three Light
Chandelier

VALENTINA

p.109

FINISH

Oxidized Bronze (OBZ)



Medium
Chandelier

ANSLEY

p.128

FINISH

■ Aged Iron (AI)

DAMP

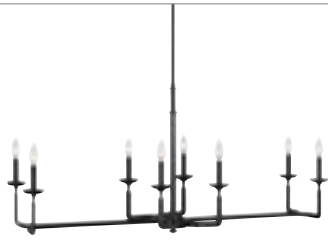

Large Linear Chandelier

BELTON

p.116

FINISHES | MATERIALS

■ Brushed Nickel (-962)
Clear Seeded Glass

■ Bronze (-710)
Clear Seeded Glass

■ Midnight Black (-112)
Clear Seeded Glass

EN* DAMP T24-1 T24-2 +



Medium Four Light Island Pendant

DUNNING

p.131

FINISH | MATERIAL

■ Stardust (-846)
Creme Parchment Glass



Four Light Linear Pendant

ELMWOOD PARK

p.120

FINISHES | MATERIALS

■ Brushed Nickel (-962) Satin Etched Inner Glass, Clear Outer Glass

■ Bronze (-710) Satin Etched Inner Glass, Clear Outer Glass

EN* DAMP T24-1 T24-2 +



Medium Four Light Island Pendant

ETHAN

p.130

FINISH | MATERIALS

■ Antique Forged Iron/Brushed Steel (AF/BS) Clear Glass



Medium Linear Chandelier

JONAH

p.119

FINISH | MATERIALS

■ Satin Nickel/ Chrome (SN/CH)
■ White Opal Etched Glass

DAMP



Medium Linear Chandelier

MITTE

p.126

FINISH | MATERIAL

■ Midnight Black (-112)
■ Clear Glass

EN ★ DAMP T24-1 T24-2



Medium Four Light Linear Lantern

MOFFET STREET

p.122

FINISHES

■ Satin Brass (-848)
■ Washed Pine (-872) with Chrome Accents
■ Brushed Nickel (-962)
■ Bronze (-710)

EN ★ DAMP T24-1 T24-2



Large Seven Light Linear Lantern



Medium Six Light Linear Lantern

OSLO

p.118

FINISHES | MATERIALS

■ Chrome (-05)
■ Cased Opal Etched Glass
■ Brushed Nickel (-962)
■ Cased Opal Etched Glass
■ Midnight Black (-112)
■ Cased Opal Etched Glass

EN ★ DAMP T24-1 T24-2 +



Medium Three Light Island Pendant

PERRYTON

p.124

FINISHES | MATERIALS

■ Chrome (-05)
■ Chrome and Cream Candle Holders
■ Satin Brass (-848)
■ Satin Brass and Cream Candle Holders
■ Bronze (-710)
■ Bronze and Satin Brass Candle Holders
■ Midnight Black (-112) Midnight Black and Chrome Candle Holders

EN ★ DAMP T24-1 T24-2

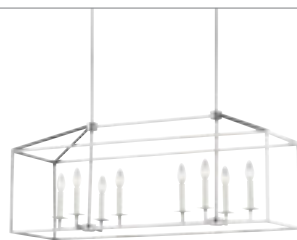

Medium Eight Light Linear Lantern

RAVENWOOD
MANOR

p.129

FINISH

■ Stardust (-846)

DAMP T24-1



Small Eight Light
Chandelier

DAWES

p.143

FINISHES

- Brushed Nickel (-962)
Clear Seeded Glass
- Bronze (-710)
Clear Seeded Glass

EN * DAMP T24-1 T24-2



Medium
Three Light
Lantern

LABETTE

p.140

FINISH

- Black (-12)

EN * DAMP T24-1 T24-2



Large
Four Light
Lantern



Medium
Three Light
Lantern



Small
Three Light
Lantern

MITTE

p.138

FINISH | MATERIAL

- Midnight Black (-112)
Clear Glass

EN * DAMP T24-1 T24-2



Large
Four Light
Lantern



Small
Four Light
Lantern



Large
One Light
Pendant

MOFFET STREET

p.136

FINISHES

- Satin Brass (-848)
- Washed Pine (-872)
with Chrome Accents
- Brushed Nickel (-962)
- Bronze (-710)

EN * DAMP T24-1 T24-2



Extra Large
Eight Light
Lantern



Large
Eight Light
Lantern



Medium
Four Light
Lantern



Small
Three Light
Lantern

PERRYTON

p.134

FINISHES

- Chrome (-05)
Chrome and Cream Candle Holders
- Satin Brass (-848)
Satin Brass and Cream Candle Holders
- Bronze (-710)
Bronze and Satin Brass Candle Holder
- Midnight Black (-112) Midnight Black and
Chrome Candle Holders

EN * DAMP T24-1 T24-2



Extra Large
Eight Light
Lantern



Large
Eight Light
Lantern



Medium
Four Light
Lantern



Small
Four Light
Lantern

VISUAL INDEX

LANTERNS

ROMEE

p.142

FINISHES

- Chrome (-05)
- Brushed Nickel (-962)
- Bronze (-710)

EN * DAMP T24-1 T24-2



Large
Eight Light
Lantern



Medium
Six Light
Lantern



Small
Three Light
Lantern

CORTES

DREW & JONATHAN
p.147

FINISH | MATERIALS
■ Satin Brass (SB) Natural Rattan
■ White Linen Fabric Shade

DAMP



Large
Hanging Shade



Medium
Hanging Shade

NANCE

p.148

FINISHES | MATERIALS
■ Brushed Nickel (-962) Off-White Faux Silk Fabric, Satin Etched Glass Diffuser
■ Bronze (-710) Off-White Faux Silk Fabric, Satin Etched Glass Diffuser

EN * T24-1 T24-2 +



Large
Three Light
Hanging Shade



Medium Two Light
Semi-Flush
Convertible
Hanging Shade

THURLO

DREW & JONATHAN
p.146

FINISH | MATERIAL
■ Satin Brass (SB)
■ Natural Abaca Rope Shade

DAMP



Large
Hanging Shade



Medium
Hanging Shade



Small
Hanging Shade

BELCARRA

DREW & JONATHAN
p.152

FINISHES | MATERIALS

- Brushed Steel (BS)
Etched White Glass
- Satin Brass (SB)
Etched White Glass
- Midnight Black (MBK)
Etched White Glass

DAMP



Medium
Pendant



Small
Pendant

BELLE

p.176

FINISHES

- Black (BK)
- Brushed Steel (BS)
- Dark Bronze (DBZ)
- Polished Nickel (PN)



Medium
Pendant

CADENCE

p.167

FINISH

- Dark Antique Brass/Matte Black
(DAB/MB)



Pendant



Mini
Pendant

DIVISION STREET

p.170

FINISHES

- Brushed Nickel (-962)
- Bronze (-710)
- Stardust (-846)

EN* DAMP T24-1 T24-2



Medium
One Light
Pendant

DRISCOLL

p.156

FINISHES | MATERIALS

- Satin Brass (-848)
Opal Etched Glass
- Brushed Nickel (-962)
Opal Etched Glass

EN* DAMP T24-1 T24-2





One Light
Mini Pendant

FREDRICKSBURG

p.171

FINISHES

-  Satin Aluminum (-04)
-  Weathered Copper (-44)
-  Black (-12)

EN* DAMP T24-1 T24-2





One Light
Indoor / Outdoor
Pendant

HOBSON

p.166

FINISHES

-  Oil Rubbed Bronze (ORB)
-  Satin Nickel (SN)



Medium
Pendant

Mini
Pendant

Mini
Pendant

HYDE

DREW & JONATHAN

p.154

FINISHES | MATERIALS

-  Matte White (MWT)
Opal Glass
-  Navy (NVY)
Opal Glass
-  Midnight Black (MBK)
Opal Glass



Large
Pendant

Medium
Pendant

Small
Pendant

JONAH

p.161

FINISH

-  Satin Nickel/Chrome (SN/CH)





Mini Pendant

KEA

p.157

FINISHES | MATERIALS

-  Bronze (-710)
Clear Seeded Glass
-  Brushed Nickel (-962)
Clear Seeded Glass

EN* DAMP T24-2



One Light
Mini Pendant

LORAS

p.159

FINISHES | MATERIALS

- Chrome (CH)
Clear Seeded Glass
- Dark Weathered Iron (DWI)
Clear Seeded Glass



Pendant



Mini
Pendant

MARINO

p.160

FINISHES | MATERIALS

- Chrome (-CH)
Clear Glass
- Satin Nickel (-SN)
Clear Glass
- Oil Rubbed Bronze (-ORB)
Clear Glass

DAMP T24-1



Medium
One Light
Pendant

MATRIMONIO

p.158

FINISH | MATERIALS

- Driftwood/Dark Weathered Zinc (DFW/DWZ)
Clear Glass



Pendant



Mini
Pendant

PEMBERTON

DREW & JONATHAN

p.155

FINISHES | MATERIALS

- Satin Brass/Matte White Shade (SBMW)
- Satin Brass Midnight Black Shade (SBMBK)



Medium
Pendant

PRATT STREET METAL

p.173

FINISHES | MATERIALS

- Satin Brass (-848)
Prismatic Glass Diffuser
- Brushed Nickel (-962)
Prismatic Glass Diffuser
- Autumn Bronze (-715)
Prismatic Glass Diffuser

EN* DAMP T24-1 T24-2



Large
Three Light
Pendant



Medium
Two Light
Pendant



Small
One Light
Pendant

**PRATT STREET
PRISMATIC**

p.172

FINISHES | MATERIALS

- Brushed Nickel (-962)
Prismatic Glass & Diffuser
- Autumn Bronze (-715)
Prismatic Glass & Diffuser

EN * DAMP T24-1 T24-2



Large
Three Light
Pendant

Medium
Two Light
Pendant

Small
One Light
Pendant

SOCORRO

p.164

FINISH

- Stardust (-846)



One Light
Mini Pendant

STONE STREET

p.174

FINISH | MATERIALS

- Brushed Nickel (-962)
Etched Glass Diffuser

EN * DAMP T24-1 T24-2 +



Large
Two Light
Pendant

Medium
One Light
Pendant

TOWNER

p.168

FINISHES | MATERIALS

- Satin Brass (-849)
Etched Glass Diffuser
- Brushed Nickel (-962)
Etched Glass Diffuser

EN * DAMP T24-1 T24-2



Five Light
Cluster

Three Light
Cluster

One Light
Mini-Pendant

URBAN RENEWAL

p.162

FINISHES

- Black (BK)
- Brushed Steel (BS)
- Dark Bronze (DBZ)
- Polished Nickel (PN)

DAMP



Bell
Pendant

Round
Glass
Pendant

Closed
Cage
Pendant

Round
Cage
Pendant

BOWAN

p.194

FINISH | MATERIAL

White (-15)
Satin Etched Glass

EN* DAMP T24-3 LED ADA



Four Foot LED
Ceiling/Wall Mount



Two Foot LED
Ceiling
Flush Mount

CLIP CEILING

p.193

FINISH | MATERIAL

Brushed Nickel (-962)
White Acrylic Diffuser

EN* DAMP T24-1 T24-2 T24-4 WOD LED



Large
Flush Mount



Medium
Flush Mount

CORTES

DREW & JONATHAN

p.184

FINISH | MATERIALS

Satin Brass (SB) Rattan/White Linen
Shade/Etched White Glass Diffuser

DAMP



Medium Ceiling
Flush Mount

DROP LENS

p.196

FINISH | MATERIAL

White (-15)
Frosted Acrylic Diffuser

DAMP T24-3 LED



LED Linear
Ceiling
Flush Mount



LED Linear
Ceiling
Flush Mount

ETHAN

p.190

FINISH | MATERIALS

Antique Forged Iron/Brushed Steel
(AF/BS) Clear Glass

DAMP



Large
Semi-Flush Mount

HYDE

DREW & JONATHAN
p.189

FINISHES | MATERIAL

- Matte White (MWT)
Milk Glass
- Navy (NVY)
Milk Glass
- Midnight Black (MBK)
Milk Glass



Medium
Flush Mount

KOLMAR

p.197

FINISH | MATERIAL

- White (-15)
White Acrylic Diffuser

EN * DAMP T24-3 LED



Four Foot
LED Ceiling
Flush Mount



Two Foot
LED Ceiling
Flush Mount

LINEAR

p.195

FINISH | MATERIAL

- White(-15)
White Acrylic Diffuser

DAMP T24-4 FL



Four Light
Ceiling
Flush Mount



Two Light
Ceiling
Flush Mount



Linear
Ceiling
Flush Mount



Linear
Ceiling
Flush Mount

MAHONE

p.187

FINISHES | MATERIALS

- Brushed Nickel (-962)
White Acrylic Diffuser
- Antique Bronze (-71)
White Acrylic Diffuser

EN * DAMP T24-3 LED



Grande Oval LED
Flush Mount



Large LED
Flush Mount



Medium LED
Ceiling
Flush Mount

MITTE

p.190

FINISH | MATERIAL

- Midnight Black (-112)
Clear Glass

EN * DAMP T24-1 T24-2



Medium Two Light
Flush Mount

NASH

p.188

FINISHES | MATERIALS

- White (-15)
Opal Etched Glass
- Chrome (-05)
Opal Etched Glass
- Brushed Nickel (-962)
Opal Etched Glass
- Satin Brass (-848)
Opal Etched Glass
- Bronze (-848)
Satin Etched Glass
- Midnight Black (-112)
Opal Etched or Amber Scavo Glass

EN* DAMP T24-1 T24-2



Large
Ceiling Flush Mount



Medium
Ceiling Flush Mount



Small
Ceiling Flush Mount

RHETT

p.185

FINISHES | MATERIALS

- Brushed Nickel (-962)
Milk Glass
- Satin Brass (-848)
Milk Glass
- Midnight Black (-112)
Milk Glass

DAMP T24-3 LED



Medium
Ceiling Flush Mount

SOCORRO

p.191

FINISH

- Stardust (-846)

EN* DAMP T24-1 T24-2



Large Three Light
Semi-Flush Mount



Large Two Light
Flush Mount

SUNSET DRIVE

p.186

FINISHES | MATERIALS

- Chrome (CH)
Opal Etched Glass
- Brushed Steel (BS)
Opal Etched Glass
- Oil Rubbed Bronze (ORB)
Opal Etched Glass

EN* DAMP T24-1 T24-2



Large Three Light
Flush Mount



Medium Two Light
Flush Mount

TOMKIN

p.192

FINISH | MATERIAL

- White (-15)
White Glass

EN* DAMP T24-1 T24-2



Small One Light
Ceiling Flush Mount,
Pull Chain



Small One Light
Ceiling
Flush Mount

WEBSTER

p.192

FINISHES | MATERIALS

- White (-15)
Smooth White Glass
 - Brushed Nickel (-962)
Smooth White Glass
 - Bronze (-71)
Smooth White Glass
- EN * DAMP T24-1 T24-2



Small Two Light
Wall / Ceiling
Flush Mount



Small One Light
Wall / Ceiling
Flush Mount

ANSLEY

p.205

FINISH | MATERIAL

■ Aged Iron (AI)
■ White Linen

DAMP



One
Light
Sconce

BURKE

DREW & JONATHAN

p.200

FINISHES | MATERIALS

■ Brushed Steel (BS)
■ White Linen Fabric Shades
■ Satin Brass (SB)
■ White Linen Fabric Shades
■ Midnight Black (MBK)
■ White Linen Fabric Shades

DAMP



Medium
Sconce

CAPALINO

DREW & JONATHAN

p.201

FINISHES | MATERIALS

■ Brushed Steel (BS)
■ White Linen Fabric Shades
■ Satin Brass (SB)
■ White Linen Fabric Shades
■ Midnight Black (MBK)
■ White Linen Fabric Shades

DAMP



Medium
Double
Sconce

EDLA

p.206

FINISH | MATERIAL

■ White (-15)
■ White Acrylic Diffuser

EN* DAMP T24-1 T24-2



One Light
Sconce

EGMONT

DREW & JONATHAN

p.201

FINISHES | MATERIALS

■ Brushed Steel (BS)
■ White Linen Fabric Shades
■ Satin Brass (SB)
■ White Linen Fabric Shades
■ Midnight Black (MBK)
■ White Linen Fabric Shades

DAMP



Medium
Sconce

ETHAN

p.204

FINISH | MATERIALS

■ Antique Forged Iron/Brushed Steel
(AF/BS) Clear Glass

T24-1



Sconce

LORAS

p.202

FINISHES | MATERIALS

■ Chrome (CH)
Clear Seeded Glass

■ Dark Weathered Iron (DWI)
Clear Seeded Glass

DAMP



Sconce

MARIELLE

p.204

FINISH

■ Antique Gild (ADB)

DAMP ADA



Double
Sconce

MARLENA

p.205

FINISH | MATERIAL

■ Antique Bronze (ANBZ)
Clear Glass

DAMP



Large
Sconce

METROPOLIS

p.207

FINISHES | MATERIALS

■ Multiple Finishes (-999), Brushed Nickel
Endcaps, Satin Etched Glass

EN * DAMP T24-1 T24-2 ADA



One Light
Sconce

MILA

p.204

FINISHES | MATERIALS

- Brushed Steel (BS)
White Opal Etched Glass
- Oil Rubbed Bronze (ORB)
White Opal Etched Glass

DAMP ADA



Wall Sconce

NEARU

p.207

FINISHES | MATERIALS

- Brushed Nickel (-962)
Opal Cased Etched Glass
- Bronze (-710)
Opal Cased Etched Glass

EN * DAMP T24-1 T24-2 ADA



One Light Sconce

NEVA

p.206

FINISH | MATERIAL

- White (-15)
White Glass

EN * DAMP T24-1 T24-2 T24-4 LED WOD ADA



One Light Sconce

PORTEAU

DREW & JONATHAN

p.200

FINISHES | MATERIAL

- Satin Brass (SB)
White Linen Fabric Shade
- Midnight Black (MBK)
White Linen Fabric Shade



Medium Sconce

RAVEL

p.207

FINISH | MATERIAL

- Brushed Nickel (-962)
Satin White Acrylic Diffuser

EN * DAMP T24-4 LED WOD ADA



LED Sconce

STEPPED GLASS

p.206

FINISH | MATERIAL

White (-15)
White Glass

EN * DAMP T24-1 T24-2



One Light
Sconce

TOWNER

p.205

FINISHES | MATERIALS

Brushed Nickel (-962)
Black Metal Shade
Satin Brass (-848)
Black Metal Shades

EN * DAMP T24-1 T24-2 +



One Light
Sconce

ABBOTT

p.246

FINISH | MATERIAL

Burnished Brass (BBS)
White Glass

DAMP T24-1 +



Three Light
Vanity



One Light
Sconce

ADELAIDE

p.220

FINISH | MATERIAL

Midnight Black (MBK)
Clear Seeded Glass

DAMP T24-1 +



Four Light
Vanity



Three Light
Vanity



Two Light
Vanity



One Light
Sconce

ALTURAS

p.236

FINISHES | MATERIALS

Chrome (-05)
Etched, White Inside Glass

Satin Brass (-848)
Etched, White Inside Glass

Brushed Nickel (-962)
Etched, White Inside Glass

Pewter Bronze (-778)
Etched, White Inside Glass

Midnight Black (-112)
Etched, White Inside Glass

EN* DAMP T24-1 T24-2 +



Four Light
Wall / Bath



Three Light
Wall / Bath



Two Light
Wall / Bath



One Light
Wall / Bath
Sconce

BAYFIELD

p.242

FINISHES | MATERIALS

Chrome (-05)
Etched, White Inside Glass

Brushed Nickel (-962)
Etched, White Inside Glass

Bronze (-710)
Etched, White Inside Glass

EN* DAMP T24-1 T24-2 +



Four Light
Wall / Bath



Three Light
Wall / Bath



Two Light
Wall / Bath



One Light
Wall / Bath
Sconce

BELCARRA

DREW & JONATHAN

p.213

FINISHES | MATERIALS

Brushed Steel (BS)
Etched White Glass

Satin Brass (SB)
Etched White Glass

Midnight Black (MBK)
Etched White Glass

DAMP +



Four Light
Wall / Bath

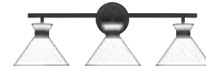

Three Light
Wall / Bath

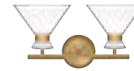

Two Light
Wall / Bath



One Light
Wall / Bath
Sconce

BELTON

p.231

FINISHES | MATERIALS

- Chrome (-05) (Wall / Bath Only)
Clear Seeded Glass
- Brushed Nickel (-962)
Clear Seeded Glass
- Bronze (-710)
Clear Seeded Glass
- Midnight Black (-112)
Clear Seeded Glass

EN * DAMP T24-1 T24-2 +



Four Light
Wall / Bath



Three Light
Wall / Bath



Two Light
Wall / Bath



One Light
Wall / Bath
Sconce

BRAUNFELS

p.248

FINISH | MATERIALS

- Satin Aluminum (-04) Frosted Acrylic
Diffuser & Clear Acrylic Outer Shade

DAMP LED ADA +



Large LED
Wall / Bath



Medium LED
Wall / Bath



Small LED
Wall / Bath

CANFIELD

p.225

FINISHES | MATERIALS

- Chrome (-05) (Wall / Bath Only)
Etched, White Inside Glass
- Brushed Nickel (-962)
Etched, White Inside Glass
- Bronze (-710)
Etched, White Inside Glass
- Midnight Black (-112)
Etched, White Inside Glass

EN * DAMP T24-1 T24-2 +



Four Light
Wall / Bath



Three Light
Wall / Bath



Two Light
Wall / Bath



One Light
Wall / Bath
Sconce

CENTER STAGE

p.250

FINISHES

- Chrome (-05)
- Brushed Stainless (-98)

DAMP T24-1 +



Eight Light
Wall / Bath



Six Light
Wall / Bath



Five Light
Wall / Bath



Four Light
Wall / Bath



Three Light
Wall / Bath

CROFTON

DREW & JONATHAN

p.211

FINISHES | MATERIALS

- Chrome (CH)
Clear Glass
- Brushed Steel (BS)
Clear Glass
- Satin Brass (SB)
Clear Glass
- Midnight Black (MBK)
Clear Glass

DAMP +



Four Light
Wall / Bath



Three Light
Wall / Bath



Two Light
Wall / Bath



One Light
Wall / Bath
Sconce

DRISCOLL

p.226

FINISHES | MATERIALS

- Chrome (-05)
Opal Etched Glass
- Brushed Nickel (-962)
Opal Etched Glass
- Satin Brass (-848)
Opal Etched Glass

EN * DAMP T24-1 T24-2 +



Four Light
Wall / Bath



Three Light
Wall / Bath



Two Light
Wall / Bath



One Light
Wall / Bath
Sconce

ELLIS HARPER

p.233

FINISH | MATERIAL

- Brushed Nickel (-962)
Etched, White Glass

EN * DAMP T24-1 T24-2 +



Four Light
Wall / Bath



Three Light
Wall / Bath



Two Light
Wall / Bath



One Light
Wall / Bath
Sconce

ELMWOOD PARK

p.224

FINISHES | MATERIALS

- Brushed Nickel (-962) Satin Etched Inner
Glass, Clear Outer Glass
- Bronze (-710) Satin Etched Inner Glass,
Clear Outer Glass

EN * DAMP T24-1 T24-2 +



Four Light
Wall / Bath



Three Light
Wall / Bath



Two Light
Wall / Bath



One Light
Wall / Bath
Sconce

EMMONS

p.245

FINISHES | MATERIALS

- Brushed Nickel (-962)
Satin Etched Glass
- Bronze (-710)
Satin Etched Glass

EN * DAMP T24-1 T24-2 +



Four Light
Wall / Bath



Three Light
Wall / Bath



Two Light
Wall / Bath



One Light
Wall / Bath
Sconce

FRANPORT

p.240

FINISHES | MATERIALS

- Chrome (-05)
Etched, White Inside Glass
- Brushed Nickel (-962)
Etched, White Inside Glass
- Bronze (-710)
Etched, White Inside Glass
- Midnight Black (-112)
Etched, White Inside Glass

EN * DAMP T24-1 T24-2 +



Four Light
Wall / Bath



Three Light
Wall / Bath



Two Light
Wall / Bath



One Light
Wall / Bath
Sconce

HANFORD

p.244

FINISHES | MATERIALS

- Brushed Nickel (-962)
Satin Etched Glass
- Bronze (-710)
Satin Etched Glass

EN ★ DAMP T24-1 T24-2 +



Four Light
Wall / Bath



Three Light
Wall / Bath



Two Light
Wall / Bath



One Light
Wall / Bath
Sconce

HETTINGER

p.234

FINISHES | MATERIALS

- Chrome (-05)
Etched, White Inside Glass
- Satin Brass (-848)
Etched, White Inside Glass
- Brushed Nickel (-962)
Etched, White Inside Glass
- Bronze (-710)
Etched, White Inside Glass
- Midnight Black (-112)
Etched, White Inside Glass

EN ★ DAMP T24-1 T24-2 +



Four Light
Wall / Bath



Three Light
Wall / Bath



Two Light
Wall / Bath



One Light
Wall / Bath
Sconce

KEMAL

p.232

FINISHES | MATERIALS

- Chrome (-05)
Etched, White Glass
- Pewter Bronze (-778)
Etched, White Glass
- Brushed Nickel (-962)
Etched, White Glass

EN ★ DAMP T24-1 T24-2 +



Four Light
Wall / Bath



Three Light
Wall / Bath



Two Light
Wall / Bath



One Light
Wall / Bath
Sconce

KERRVILLE

p.230

FINISHES | MATERIALS

- Chrome (-05)
Satin Etched Glass
- Brushed Nickel (-962)
Satin Etched Glass
- Bronze (-710)
Satin Etched Glass

EN ★ DAMP T24-1 T24-2 +



Four Light
Wall / Bath



Three Light
Wall / Bath



Two Light
Wall / Bath



One Light
Wall / Bath
Sconce

MITTE

p.218

FINISH | MATERIAL

- Midnight Black (-112)
Clear Glass

EN ★ DAMP T24-1 T24-2 +



Four Light
Wall / Bath



Three Light
Wall / Bath



Two Light
Wall / Bath



One Light
Wall / Bath
Sconce

OSLO

p.222

FINISHES | MATERIALS

- Chrome (-05) Cased Opal Etched or Clear Seeded Glass
- Brushed Nickel (-962) Cased Opal Etched or Clear Seeded Glass
- Bronze (-710) Cased Opal Etched or Clear Seeded Glass
- Midnight Black (-112) Cased Opal Etched or Clear Seeded Glass

EN * DAMP T24-1 T24-2 +



Four Light Wall / Bath



Three Light Wall / Bath



Two Light Wall / Bath



One Light Wall / Bath Sconce

PROSPECT PARK

p.239

FINISH | MATERIALS

- Satin Nickel/Chrome (SN/CH) White Opal Etched Glass

DAMP



Three Light Vanity



Two Light Vanity



One Light Sconce

ROBIE

p.238

FINISHES | MATERIALS

- Chrome (-05) (Wall / Bath Only) Etched, White Inside Glass
- Brushed Nickel (-962) Etched, White Inside Glass
- Bronze (-710) Etched, White Inside Glass
- Midnight Black (-112) Etched, White Inside Glass

EN * DAMP T24-1 T24-2 +



Four Light Wall / Bath



Three Light Wall / Bath



Two Light Wall / Bath



One Light Wall / Bath Sconce

SAYWARD

DREW & JONATHAN

p.210

FINISHES | MATERIALS

- Chrome (CH) Clear Glass
- Brushed Steel (BS) Clear Glass
- Satin Brass (SB) Clear Glass
- Midnight Black (MBK) Clear Glass

DAMP +



Four Light Wall / Bath



Three Light Wall / Bath



Two Light Wall / Bath



One Light Wall / Bath Sconce

SEVILLE

p.228

FINISHES | MATERIALS

- Chrome (-05) Etched, White Inside Glass
- Brushed Nickel (-962) Etched, White Inside Glass
- Bronze (-710) Etched, White Inside Glass

EN * DAMP T24-1 T24-2 +



Five Light Wall / Bath



Four Light Wall / Bath



Three Light Wall / Bath



Two Light Wall / Bath



One Light Wall / Bath Sconce

TOFFINO

DREW & JONATHAN
p.212

FINISHES | MATERIALS

- Chrome (CH)
Milk Glass
- Brushed Steel (BS)
Milk Glass
- Satin Brass (SB)
Milk Glass
- Midnight Black (MBK)
Milk Glass

DAMP +



Four Light
Wall / Bath



Three Light
Wall / Bath



Two Light
Wall / Bath



One Light
Wall / Bath
Sconce

TOWNER

p.216

FINISHES | MATERIALS

- Brushed Nickel (-962)
Black Metal Shades
- Satin Brass (-848)
Black Metal Shades

EN* DAMP T24-1 T24-2 +



Four Light
Wall / Bath



Three Light
Wall / Bath



Two Light
Wall / Bath



One Light
Wall / Bath
Sconce

URBAN RENEWAL

p.219

FINISHES

- Polished Nickel (PN)
- Dark Antique Brass (DAB)

DAMP T24-1 +



Two Light
Wall / Bath



One Light
Wall / Bath
Sconce

VANDEVENTER

p.249

FINISH | MATERIAL

- Brushed Nickel (-962)
White Acrylic Diffuser

DAMP T24-1 T24-3 ADA LED +



Medium LED
Wall / Bath



Small LED
Wall / Bath



LED Wall /
Bath
Sconce

WINDOM

p.214

FINISHES | MATERIALS

- Chrome (-05) (Wall / Bath Only)
Etched Opal Glass
- Brushed Nickel (-962)
Etched Opal Glass
- Satin Brass (-848)
Etched Opal Glass
- Bronze (-710)
Etched Opal Glass
- Midnight Black (-112)
Etched Opal Glass

EN* DAMP T24-1 T24-2 +



Four Light
Wall / Bath



Three Light
Wall / Bath



Two Light
Wall / Bath



One Light
Wall / Bath
Sconce

ETHAN

p.252

FINISH | MATERIAL

- Antique Forged Iron (AF)
Mirror Glass



Rectangular
Mirror

INFINITY

p.252

MATERIAL

- Beveled Glass Mirror



Large
Rectangular
Mirror



Medium
Rectangular
Mirror

JACKIE

p.253

FINISH | MATERIAL

- Oil Rubbed Bronze (ORB)
Mirror Glass



Oval Mirror

KIT

p.253

FINISHES | MATERIALS

- Burnished Brass (BBS)
Mirror Glass
- Midnight Black (MBK)
Mirror Glass
- Polished Nickel (PN)
Mirror Glass



Oval Mirror



Round Mirror



Rectangular
Mirror

LED STEP/
HALL LIGHTING

p.256

FINISHES

White (-15)

Antique Bronze (-171)

Satin Nickel (-849)



Louver LED Step Light



Tarpa LED Step Light



Vitra LED Step Light



Louver LED Brick Light



Tarpa LED Brick Light



Vitra LED Brick Light

ADDRESS LIGHTS

p.346

FINISHES

- White (-15)
- White Plastic (-68)
- Antique Bronze (-71)
- Black (-12)

WET LED



120V LED Address Light



Low-Voltage Address Light



Low-Voltage Address Light Transformer



Number Tiles

ALBAN

p.262

FINISHES | MATERIALS

- Satin Aluminum (-04)
- Cylindrical or Square Glass
- Antique Bronze (-71)
- Cylindrical or Square Glass
- Black (-12)
- Cylindrical or Square Glass

EN* WET T24-1 T24-2



Large One Light Outdoor Wall Lantern



Large One Light Outdoor Wall Lantern



Medium One Light Outdoor Wall Lantern



Medium One Light Outdoor Wall Lantern



Small One Light Outdoor Wall Lantern



Small One Light Outdoor Wall Lantern

BAKERSVILLE

p.284

FINISHES | MATERIALS

- Antique Bronze (-71)
- Clear Beveled or Satin Etched Glass
- Black (-12)
- Clear Beveled or Satin Etched Glass

EN* WET DAMP T24-1 T24-2



One Light Outdoor Wall Lantern



One Light Outdoor Wall Lantern



Small One Light Outdoor Wall Lantern



Small One Light Outdoor Wall Lantern



Two Light Outdoor Ceiling Flush Mount



One Light Outdoor Pendant



One Light Outdoor Post Lantern

BAYSIDE

p.338

FINISHES | MATERIALS

- White Polycarbonate (-15)
- Frosted Ribbed Diffuser
- Black Polycarbonate (-12)
- Frosted Ribbed Diffuser

EN* WET T24-1 T24-2 + ADA



One Light Outdoor Wall Lantern



One Light Outdoor Wall Lantern



One Light Outdoor Wall Lantern



One Light Outdoor Wall / Ceiling Mount



One Light Outdoor Wall / Ceiling Mount

BRENTWOOD

p.304

FINISH | MATERIALS

■ Black (-12) Clear Beveled Glass or Etched, White Inside Glass

EN ★ WET DAMP T24-1 T24-2



Medium One Light Uplight Outdoor Wall Lantern

Medium One Light Downlight Outdoor Wall Lantern

Small One Light Outdoor Wall Lantern

Two Light Outdoor Ceiling Flush Mount

One Light Outdoor Pendant

One / Three Light Outdoor Post Lantern

CALDER

p.320

FINISH | MATERIAL

■ Antique Bronze (-71) Satin Etched Glass

EN ★ WET T24-1 T24-2 SS



Large One Light Outdoor Wall Lantern

Medium One Light Downlight Outdoor Wall Lantern

Small One Light Outdoor Wall Lantern

One Light Outdoor Post Lantern

CAPE MAY

p.282

FINISHES | MATERIALS

■ Burled Iron (-780) Etched, Hammered Glass with Light Amber Tint

■ Black (-12) Etched, White Inside Glass

EN ★ WET DAMP T24-1 T24-2 ☾



Extra Large One Light Outdoor Wall Lantern

Large One Light Outdoor Wall Lantern

Extra Large One Light Uplight Outdoor Wall Lantern

Medium One Light Outdoor Wall Lantern

Small One Light Outdoor Wall Lantern

One Light Outdoor Pendant

One Light Outdoor Post Lantern

CHATHAM

p.278

FINISHES | MATERIALS

■ Weathered Copper (-44) Clear Seeded Glass with White Aluminum Backing, Frosted Seeded Glass or Clear Seeded Glass

■ Oxidized Bronze (-46) Clear Seeded Glass with White Aluminum Backing, Frosted Seeded Glass or Clear Seeded Glass

EN ★ WET DAMP T24-1 T24-2 ☾



Large Two Light Outdoor Wall Lantern

Small One Light Outdoor Wall Lantern

Two Light Outdoor Post Lantern

CHILDRESS

p.276

FINISHES | MATERIALS

■ Antique Bronze (-71) Satin Etched Glass

■ Black (-12) Satin Etched Glass

EN ★ WET T24-1 T24-2



Large One Light Outdoor Wall Lantern

Medium One Light Outdoor Wall Lantern

Small One Light Outdoor Wall Lantern

Outdoor One Light Post Lantern

CLASSICO

p.302

FINISHES | MATERIALS

- Polished Brass (-02)
Clear Beveled Glass
- Black (-12) Clear Beveled Glass or
Clear Seeded Glass

WET DAMP T24-1 +



Large
One Light
Outdoor
Wall Lantern



Medium
One Light
Outdoor
Wall Lantern



Small
One Light
Outdoor
Wall Lantern



One Light
Outdoor
Semi-Flush
Convertible Pendant



One Light
Outdoor
Semi-Flush
Convertible Pendant



One Light
Outdoor
Post Lantern

COTSWOLD LANE

p.308

FINISHES | MATERIALS

- Grecian Bronze (GBZ)
Clear Beveled Glass
- Black (BK)
Clear Beveled Glass

WET DAMP



Extra Large
Outdoor
Wall Lantern



Large
Outdoor
Wall Lantern



Medium
Outdoor
Wall Lantern



Small
Outdoor
Wall Lantern



Extra Small
Outdoor
Wall Lantern



Large
Outdoor
Pendant



Medium
Outdoor
Pendant



Small
Outdoor
Pendant



Outdoor
Flush
Mount



Pocket
Outdoor
Wall Lantern



Large
Outdoor
Post



Small
Outdoor
Post

CRITTENDEN

p.332

FINISHES

- Satin Aluminum (-04)
(Medium only)
- Black (-12)

EN* WET T24-1 T24-2 C



Large
One Light
Outdoor
Wall Lantern



Medium
One Light
Outdoor
Wall Lantern



Small
One Light
Outdoor
Wall Lantern

CROWELL

p.274

FINISHES | MATERIALS

- Antique Bronze (-71)
Creme Parchment Glass
- Black (-12)
Satin Etched Glass

EN * WET DAMP T24-1 T24-2 ☾



Large
One Light
Outdoor
Wall Lantern



Medium
One Light
Outdoor
Wall Lantern



Small
One Light
Outdoor
Wall Lantern



Two Light
Outdoor
Ceiling
Flush Mount



One Light
Outdoor
Post Lantern

DAKOTA

p.318

FINISH | MATERIALS

- Espresso (ES)
Clear Seeded Glass or Acid Etched
Outside Spray/White Inside Glass

WET



Large
Outdoor
Wall Lantern



Medium
Outdoor
Wall Lantern



Small
Outdoor
Wall Lantern



Extra Small
Outdoor
Wall Lantern



Flush
Mount



One Light
Outdoor
Post Lantern

DARBY

p.331

FINISH

- Oil Rubbed Bronze (ORB)

WET



Outdoor
Wall Lantern

EDDINGTON

p.277

FINISHES | MATERIALS

- Antique Bronze (-71)
Cased Opal Etched Glass
- Black (-12)
Cased Opal Etched Glass

EN * WET T24-1 T24-2



Large
One Light
Outdoor
Wall Lantern



Medium
One Light
Outdoor
Wall Lantern



Small
One Light
Outdoor
Wall Lantern

FLOOD LIGHTS

p.348

FINISHES | MATERIALS

- Antique Bronze (-71)
Aluminum
- Black (-12)
Aluminum
- White (-15)
Aluminum or Polycarbonate

EN * WET T24-1 T24-2 +



One Light with
Photo & Motion
Sensor



One Light
Adjustable
Swivel



Two Light with
Photo & Motion
Sensor



Two Light
Adjustable
Swivel



Two Light
Adjustable
Swivel

FREDRICKSBURG

p.334

FINISHES

- Satin Aluminum (-04)
- Weathered Copper (-44)
- Black (-12)

EN* WET DAMP T24-1 T24-2 T24-4 ☾ ⚡



Large
One Light
Outdoor
Wall Lantern



Small
One Light
Outdoor
Wall Lantern



Indoor / Outdoor
Pendant

HERRINGTON

p.296

FINISH | MATERIALS

- Black (-12)
- Clear Seeded or Etched, White Inside

EN* WET DAMP T24-1 T24-2



Medium
One Light
Outdoor
Wall Lantern



Small
One Light
Outdoor
Wall Lantern



Two Light
Outdoor
Ceiling
Flush Mount



One Light
Outdoor
Pendant



One Light
Outdoor
Post Lantern

HUNNINGTON

p.326

FINISHES | MATERIALS

- Weathered Pewter (-57)
- Clear Seeded or Etched Seeded Glass
- Black (-12)
- Clear Seeded or Etched Seeded Glass

WET DAMP T24-1



Large
One Light
Outdoor
Wall Lantern



Small
One Light
Outdoor
Wall Lantern



Two Light
Outdoor
Ceiling
Flush Mount



One Light
Outdoor
Pendant



One Light
Outdoor
Post Lantern

JAMESTOWNE

p.298

FINISHES | MATERIALS

- Antique Brushed Nickel (-965)
- Clear Beveled Glass
- Antique Bronze (-71)
- Clear Beveled Glass
- Antique Bronze (-71) Frosted Seeded Glass or Etched Tiffany Glass with White Aluminum Backing
- Black (-12)
- Clear Beveled Glass
- Black (-12) Etched Tiffany Glass with White Aluminum Backing

EN* WET T24-1 T24-2 ☾



Extra Large
Two Light
Outdoor
Wall Lantern



Large
One Light
Outdoor
Wall Lantern



Medium
One Light
Outdoor
Wall Lantern



Small
One Light
Outdoor
Wall Lantern



One Light
Outdoor
Post Lantern

KENT

p.292

FINISHES | MATERIALS

- Oxford Bronze (-746)
Clear Seeded or Satin Etched Glass
- Black (-12)
Clear Beveled or Satin Etched Glass

EN* WET DAMP T24-1 T24-2



Extra Large
One Light
Outdoor
Wall Lantern



Medium
One Light
Outdoor
Wall Lantern



Large
One Light
Outdoor
Wall Lantern



Small
One Light
Outdoor
Wall Lantern



One Light Outdoor
Semi-Flush
Convertible
Pendant



One Light
Outdoor
Pendant



One Light
Outdoor
Post Lantern

LANCASTER

p.300

FINISHES | MATERIALS

- Polished Brass (-02)
Clear Curved Beveled Glass
- Antique Brushed Nickel (-965)
Clear Curved Beveled Glass
- Antique Bronze (-71)
Clear Curved Beveled Glass
- Black (-12)
Clear Curved Beveled Glass

EN* WET DAMP T24-1 T24-2



Extra Large
Three Light
Outdoor
Wall Lantern



Large
Two Light
Outdoor
Wall Lantern



Medium
One Light
Outdoor
Wall Lantern



Medium
One Light
Outdoor
Wall Lantern



Small
One Light
Outdoor
Wall Lantern



Large
Three Light
Outdoor
Pendant



Medium
Two Light
Outdoor
Post Lantern



Large
Three Light
Outdoor
Post Lantern

LENNEX

p.331

FINISH

- Slate Grey Metal (SGM)

WET



Rectangular
Plate
Wall Lantern

LIGHTHOUSE

p.322

FINISH | MATERIAL

■ Burnished Bronze (BB)
Opal Etched Glass

WET



Large
Outdoor
Wall Lantern



Small
Outdoor
Wall Lantern

MARKET SQUARE

p.328

FINISH | MATERIAL

■ Oil Rubbed Bronze (ORB)
Clear Seeded Glass

WET



Large
Outdoor
Wall Lantern



Medium
Outdoor
Wall Lantern

MARTINSVILLE

p.281

FINISHES | MATERIALS

■ Corinthian Bronze (CB)
Clear Seeded Glass
■ Black (BK)
Clear Seeded Glass

EN* WET DAMP T24-1 T24-2



Extra Large
Four Light
Outdoor
Wall Lantern



Large
Three Light
Outdoor
Wall Lantern



Medium
Two Light
Outdoor
Wall Lantern



Small
One Light
Outdoor
Wall Lantern



Three Light
Outdoor
Pendant



Three Light
Outdoor
Post Lantern

MEDFORD LAKES

p.330

FINISH | MATERIALS

■ Statuary Bronze (-S1) Etched Hammered
with Light Amber Tint Glass

EN* WET T24-1 T24-2



Large One
Light Outdoor
Wall Lantern



Medium One
Light Outdoor
Wall Lantern



Small One
Light Outdoor
Wall Lantern

MILLBROOKE

p.316

FINISH | MATERIAL

■ Antique Bronze (ANBZ)
Water Glass

WET DAMP SS**



Extra Large
Outdoor
Wall Lantern



Large
Outdoor
Wall Lantern



Medium
Outdoor
Wall Lantern



Small
Outdoor
Wall Lantern



Extra Small
Outdoor
Wall Lantern



Post
Lantern



Pendant

MULLBERRY HILL

p.324

FINISHES | MATERIALS

- White (-15)
Clear or White Glass
- Pewter (-155)
Clear or White Glass
- Bronze (-10)
Clear or White Glass
- Black (-12)
Clear or White Glass

EN * WET T24-1 T24-2



One Light
Outdoor
Wall Lantern



One Light
Outdoor
Wall Lantern



One Light
Outdoor
Wall Lantern



One Light
Outdoor
Wall Lantern

NEW CASTLE

p.325

FINISHES | MATERIALS

- White (-15)
Clear or Satin Etched Glass
- Antique Brushed Nickel (-965)
Clear or Satin Etched Glass
- Antique Bronze (-71)
Clear or Satin Etched Glass
- Black (-12)
Clear or Satin Etched Glass

EN * WET T24-1 T24-2



Large
One Light
Outdoor
Wall Lantern



Large
One Light
Outdoor
Wall Lantern



Small
One Light
Outdoor
Wall Lantern



Small
One Light
Outdoor
Wall Lantern

OUTDOOR CEILING FLUSH MOUNT

p.343

FINISHES | MATERIALS

- White Polypropylene (-15)
Clear Textured Glass
- Black Polypropylene (-15)
Clear Textured Glass

DAMP T24-1



Two Light
Outdoor
Ceiling Flush
Mount



Two Light
Outdoor
Ceiling Flush
Mount



Two Light
Outdoor
Ceiling Flush
Mount

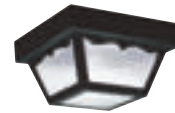

One Light
Outdoor
Ceiling Flush
Mount

OUTDOOR POST LANTERNS

p.344

FINISHES | MATERIALS

- Black Polypropylene (-32)
Clear Beveled Acrylic Diffuser
- Black (-12) Frosted or Clear Beveled
Acrylic Diffuser
- Black Polycarbonate (-68)
White Acrylic Diffuser

EN * WET T24-1 T24-2



One Light
Outdoor
Post Lantern



One Light
Outdoor
Post Lantern



One Light
Outdoor
Post Lantern



One Light
Outdoor
Post Lantern



One Light
Outdoor
Post Lantern

OUTDOOR WALL LANTERNS

p.342

FINISHES | MATERIALS

- Black Polypropylene (-32)
Clear Beveled Acrylic Diffuser
- White Polycarbonate (-15) Clear Glass or
Clear Beveled Acrylic
- Black (-12) Clear or Satin Etched Glass or
White Polycarbonate Diffuser

EN * WET T24-1 T24-2 +



One Light
Outdoor
Wall Lantern



One Light
Outdoor
Wall Lantern

OUTDOOR WALL SCONCES

p.340

FINISHES | MATERIALS

- White Polycarbonate (-15)
- White Glass
- Black Polycarbonate (-34)
- White Glass

EN* WET T24-1 T24-2



One Light Outdoor Wall Lantern



One Light Outdoor Wall Lantern



One Light Outdoor Wall Lantern



One Light Outdoor Wall Lantern



One Light Outdoor Wall Lantern



One Light Outdoor Wall Lantern

PAINTABLE CERAMIC WALL SCONCES

p.341

FINISH

- Paintable Ceramic (-714)

EN* WET T24-1 T24-2 ☾ ☼



Half Moon One Light Outdoor Wall Lantern



Rectangle One Light Outdoor Wall Lantern



Striation One Light Outdoor Wall Lantern

RANDHURST

p.331

FINISH

- Copper Oxide (CO)

WET SS ☼



Large Outdoor Wall Lantern

REDDING STATION

p.336

FINISHES

- Tarnished Silver (TRD)
- Restoration Bronze (RSZ)
- Textured Black (TXB)

WET



Large Outdoor Wall Lantern



Medium Outdoor Wall Lantern



Small Outdoor Wall Lantern



Outdoor Pendant

RENVILLE

p.264

FINISHES | MATERIALS

- Antique Bronze (-71)
- Satin Etched Glass
- Black (-12)
- Satin Etched Glass

EN* WET T24-1 T24-2



Large One Light Outdoor Wall Lantern



Small One Light Outdoor Wall Lantern

ROSCOE

p.323

FINISH | MATERIAL

- Textured Black (TXB)
White Opal Etched Glass

WET SS+2



Large
Outdoor
Wall Lantern



Medium
Outdoor
Wall Lantern



Small
Outdoor
Wall Lantern

SEBRING

p.335

FINISHES | MATERIALS

- Weathered Copper (-44)
Clear Seeded Glass
- Brushed Stainless (-98)
Clear Seeded Glass
- Black (-12)
Clear Seeded Glass

EN* WET DAMP T24-1 T24-2



Large
One Light
Outdoor
Wall Lantern



Small
One Light
Outdoor
Wall Lantern



One Light
Outdoor
Flush Mount



One Light
Outdoor
Post Lantern

SEVIER

p.288

FINISHES | MATERIALS

- Antique Bronze (-71)
Satin Etched or Clear Glass
- Black (-12)
Satin Etched or Clear Glass

EN* WET DAMP T24-1 T24-2



Extra Large
One Light
Downlight
Outdoor
Wall Lantern



Large
One Light
Downlight
Outdoor
Wall Lantern



Medium
One Light
Downlight
Outdoor
Wall Lantern



Small
One Light
Downlight
Outdoor
Wall Lantern



Large
One Light
Uplight
Outdoor
Wall Lantern



Medium
One Light
Uplight
Outdoor
Wall Lantern



Small
One Light
Uplight
Outdoor
Wall Lantern



One Light
Outdoor
Pendant



Large
One Light
Outdoor Post
Lantern



Medium
One Light
Outdoor Post
Lantern

TOMEK

p.272

FINISHES | MATERIALS

- Antique Bronze (-71)
Etched, White Inside Glass
- Black (-12)
Etched, White Inside Glass

EN* WET DAMP T24-1 T24-2



Large
One Light
Outdoor
Wall Lantern



Medium
One Light
Outdoor
Wall Lantern



Small
One Light
Outdoor
Wall Lantern



One Light
Outdoor
Post Lantern

TRAFALGAR

p.280

FINISH | MATERIAL
 ■ Oxidized Bronze (-46)
 ■ Clear Seeded Glass

EN* WET T24-1 T24-2



Large
Three Light
Outdoor
Wall Lantern



Medium
Two Light
Outdoor
Wall Lantern



Small
Two Light
Outdoor
Wall Lantern



Three Light
Outdoor
Post Lantern

TYBEE

p.270

FINISHES | MATERIAL
 ■ Antique Bronze (-71)
 ■ Clear Glass

■ Black (-12)
 ■ Clear Glass

EN* WET DAMP T24-1 T24-2



Extra Large
One Light
Outdoor
Wall Lantern



Large
One Light
Outdoor
Wall Lantern



Medium
One Light
Outdoor
Wall Lantern



Small
One Light
Outdoor
Wall Lantern



One Light
Outdoor
Pendant



One Light
Outdoor
Post Lantern

WHITAKER

p.329

FINISH | MATERIAL
 ■ Astral Bronze (ASTB)
 ■ Clear Seeded Glass

WET



Large
Outdoor
Wall Lantern



Small
Outdoor
Wall Lantern

WILBURN

p.266

FINISHES | MATERIAL
 ■ Antique Bronze (-71)
 ■ Etched, White Inside Glass

■ Black (-12)
 ■ Etched, White Inside Glass

EN* WET DAMP T24-1 T24-2 ☾



Extra Large
One Light
Outdoor
Wall Lantern



Large
One Light
Outdoor
Wall Lantern



Medium
One Light
Outdoor
Wall Lantern



Small
One Light
Outdoor
Wall Lantern



Two Light
Outdoor
Flush Mount



One Light
Outdoor
Pendant



One Light
Outdoor Post
Lantern

WYNFIELD

p.314

FINISHES | MATERIALS

Black Powdercoat-12)
Frosted or Clear Beveled Glass

EN * WET DAMP T24-1 T24-2



Large
Two Light
Outdoor
Wall Lantern



Medium
One Light
Outdoor
Wall Lantern



Small
One Light
Outdoor
Wall Lantern



Extra Small
One Light
Outdoor
Wall Lantern



Two Light
Outdoor Ceiling
Flush Mount



Medium
Two Light
Outdoor
Post Lantern



Small
One Light
Outdoor
Post Lantern

COLONY

p.380

FINISHES | MATERIALS

- Roman Bronze Housing with Bronze/American Walnut Reversible Blades
- Brushed Steel Housing with Silver/American Walnut Reversible Blades
- Midnight Black Housing with American Walnut/Midnight Black Reversible Blades
- Aged Pewter Housing with Light Grey Weathered Oak Blades
- Matte White Housing with Matte White Blades



Colony 60 LED



Colony 60



Colony 52 LED



Colony 52

CRUISE

p.395

FINISHES | MATERIALS

- Roman Bronze Housing with American Walnut ABS Blades
- Midnight Black Housing with Black ABS Blades
- White Housing with White ABS Blades



Cruise Outdoor 52

DISCUS

p.375, 394

FINISHES | MATERIALS

- Brushed Steel Housing with Silver/American Walnut Reversible Blades
- Aged Pewter Housing with Light Grey Weathered Oak Blades
- Midnight Black Housing with Midnight Black Blades
- Matte White Housing with Matte White Blades
- Roman Bronze Housing with Bronze/American Walnut Reversible Blades
- Polished Nickel Housing with Silver/American Walnut Reversible Blades
- Matte Black Housing with Matte Black Blades
- Painted Brushed Steel Housing with Painted Brushed Steel ABS Blades



Discus Smart 52 LED



Discus Classic 52 LED



Discus Classic 44 LED



Discus Ornate 52 LED



Discus Outdoor 52 LED

ERA

p.364

FINISHES | MATERIALS

- Brushed Steel Housing with Silver/American Walnut Reversible Blades
- Aged Pewter Housing with Light Grey Weathered Oak Blades
- Matte White Housing with Matte White Blades
- Midnight Black Housing with Midnight Black/American Walnut Reversible Blades



Era 52 LED



Era 52 Hugger LED



Era 44 LED



Era 44 Hugger LED

JOVIE

p.356, 390

FINISHES | MATERIALS

- Brushed Steel Housing with Silver/American Walnut Reversible Blades
- Aged Pewter Housing with Light Grey Weathered Oak Blades
- Matte White Housing with Matte White Blades
- Midnight Black Housing with Midnight Black/American Walnut Reversible Blades



Jovie 58 LED



Jovie 58



Jovie 52 LED



Jovie 52



Jovie 44 LED



Jovie 44

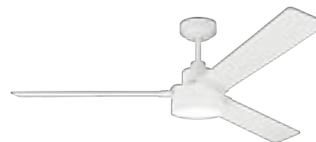

Jovie Outdoor 58 LED







Jovie Outdoor 58

LINDEN

p.384, 392

FINISHES | MATERIALS

-  Brushed Steel Housing with Silver/American Walnut Reversible Blades
-  Aged Pewter Housing with Light Grey Weathered Oak Blades
-  Matte White Housing with Matte White Blades
-  Midnight Black Housing with Midnight Black/American Walnut Reversible Blades



Linden DC 52 LED



Linden 52 LED



Linden 52 LED 3



Linden 52



Linden 48 LED



Linden 48 LED



Linden Outdoor 52 LED

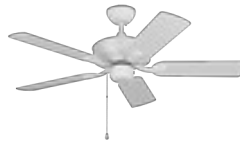





Linden Outdoor 44

LOWDEN

p.370

FINISHES | MATERIALS

-  Brushed Steel Housing with Silver/American Walnut Reversible Blade
-  Brushed Steel Housing with Silver/Light Grey Weathered Oak Reversible Blades
-  Midnight Black Housing with Midnight Black/American Walnut Reversible Blades
-  Aged Pewter Housing with Light Grey Weathered Oak Blades
-  Matte White Housing with Matte White Blades



Lowden Smart 60 LED







Lowden 52 LED

ORBIS

p.372

FINISHES | MATERIALS

-  Satin Brass Housing with Matte White Blades
-  Brushed Steel Housing with Silver/American Walnut Reversible Blades
-  Midnight Black Housing with Midnight Black/American Walnut Reversible Blades
-  Matte White Housing with Matte White Blades



Orbis 52 LED



Orbis 52 Hugger LED

SYRUS

p.374

FINISHES | MATERIALS

- Midnight Black Housing with Midnight Black/American Walnut Reversible Blades
- Brushed Steel Housing with Silver/American Walnut Reversible Blades
- Oil Rubbed Bronze Housing with Oil Rubbed Bronze/American Walnut Reversible Blades
- Matte White Housing with Matte White Blades



Syrus 52 LED

TITUS

p.368

FINISHES | MATERIALS

- Satin Brass Housing with Matte White ABS Blades
- Brushed Steel Housing with Silver ABS Blades
- Midnight Black Housing with Midnight Black ABS Blades
- Matte White Housing with Matte White ABS Blades



Titus 54 Hugger LED



Titus 44 Hugger LED

ALTURAS

p.462

FINISHES | MATERIALS

- Chrome (-05) (Wall / Bath Only)
Etched White Glass
- Satin Brass (-848) Opal Etched Glass or
Clear Seeded Glass Shades
- Brushed Nickel (-962) Opal Etched Glass or
Clear Seeded Glass Shades
- Pewter Bronze (-778) Opal Etched Glass or
Clear Seeded Glass Shades
- Midnight Black (-112) Opal Etched Glass or
Clear Seeded Glass Shades

EN * DAMP T24-1 T24-2 +



Large
Nine Light
Chandelier



Medium
Five Light
Chandelier



Small
Three Light
Chandelier



Medium
Three Light
Pendant



One Light
Mini-Pendant



Two Light
Semi-Flush
Convertible
Pendant



Four Light
Wall / Bath



Three Light
Wall / Bath



Two Light
Wall / Bath



One Light
Wall / Bath
Sconce

BELTON

p.488

FINISHES | MATERIALS

- Chrome (-05) (Wall / Bath Only)
Clear Seeded Glass
- Brushed Nickel (-962)
Clear Seeded Glass
- Bronze (-710)
Clear Seeded Glass
- Midnight Black (-112)
Clear Seeded Glass

EN * DAMP T24-1 T24-2 +



Large Nine Light Up
Chandelier



Medium Five Light Up
Chandelier



Medium Five Light
Chandelier



Small Three Light
Chandelier



Medium Four Light
Island Pendant



Large
One Light
Pendant



Medium
One Light
Pendant



One Light
Pendant



One Light
Mini-
Pendant



Medium
Two Light
Semi-Flush
Mount



Small Three
Light Ceiling
Flush Mount



Four Light
Wall / Bath



Three Light
Wall / Bath



Two Light
Wall / Bath



One Light
Wall / Bath
Sconce

CANFIELD

p.492

FINISHES | MATERIALS

- Chrome (-05) (Wall / Bath Only)
Etched White Glass
- Brushed Nickel (-962)
Etched White Glass
- Bronze (-710)
Etched White Glass
- Midnight Black (-112)
Etched White Glass

EN * DAMP T24-1 T24-2 +



Large Nine Light Chandelier



Medium Five Light Chandelier



Small Three Light Chandelier



Large Three Light Uplight Pendant



One Light Mini-Pendant



Large Three Light Semi-Flush Mount



Four Light Wall / Bath



Three Light Wall / Bath



Two Light Wall / Bath



One Light Wall / Bath Sconce

ELLIS HARPER

p.504

FINISH | MATERIAL

- Brushed Nickel (-962)
Etched White Glass

EN * DAMP T24-1 T24-2 +



Large Eight Light Chandelier



Medium Four Light Chandelier



One Light Mini-Pendant



Medium Two Light Ceiling Semi-Flush Mount



Medium Two Light Ceiling Flush Mount



Four Light Wall / Bath



Three Light Wall / Bath



Two Light Wall / Bath



One Light Wall / Bath Sconce

ELMWOOD PARK

p.518

FINISHES | MATERIALS

- Brushed Nickel (-962) Satin Etched Inner Glass, Clear Outer Glass
- Bronze (-710) Satin Etched Inner Glass, Clear Outer Glass

EN * DAMP T24-1 T24-2 +



Large
Nine Light
Chandelier



Medium
Five Light
Chandelier



Small
Three Light
Chandelier



Medium
Four Light
Island Pendant



Medium
Three Light
Hanging Shade



One Light
Mini-Pendant



Large
Three Light
Semi-Flush
Mount



Medium
Two Light
Semi-Flush
Mount



Medium
Two Light
Ceiling
Flush Mount



Four Light
Wall / Bath



Three Light
Wall / Bath



Two Light
Wall / Bath



One Light
Wall / Bath
Sconce

EMMONS

p.522

FINISHES | MATERIALS

- Brushed Nickel (-962) Satin Etched Glass
- Bronze (-710) Satin Etched Glass

EN * DAMP T24-1 T24-2 +



Extra Large
Twelve Light
Chandelier



Large
Nine Light
Chandelier



Medium
Five Light
Chandelier



Small
Three Light
Chandelier



Large
Three Light
Pendant



One Light
Mini-Pendant



Medium
Two Light
Semi-Flush
Mount



Four Light
Wall / Bath



Three Light
Wall / Bath



Two Light
Wall / Bath



One Light
Wall / Bath
Sconce

FRANPORT

p.506

FINISHES | MATERIALS

- Chrome (-05) (Wall / Bath Only)
Etched White Glass
- Brushed Nickel (-962)
Satin Etched Glass
- Bronze (-710)
Satin Etched Glass
- Midnight Black (-112) (Wall/Bath Only)
Etched White Glass

EN ★ DAMP T24-1 T24-2 +



Large
Nine Light
Chandelier



Medium
Five Light
Chandelier



Small
Three Light
Chandelier



Large
Three Light
Pendant



Large
Three Light
Semi-Flush
Convertible Pendant



Four Light
Wall / Bath



Three Light
Wall / Bath



Two Light
Wall / Bath



One Light
Wall / Bath
Sconce

GEARY

p.526

FINISHES | MATERIALS

- Chrome (-05)
Satin Etched Glass
- Brushed Nickel (-962)
Satin Etched Glass
- Satin Brass (-848)
Satin Etched Glass
- Bronze (-710)
Satin Etched or Amber Scavo Glass
- Midnight Black (-112)
Satin Etched Glass

EN ★ DAMP T24-1 T24-2 +



Medium
Three Light
Pendant



Medium
One Light
Pendant



Medium
Three Light
Semi-Flush /
Pendant



Small Two Light
Semi-Flush /
Pendant

HANFORD

p.514

FINISHES | MATERIALS

Brushed Nickel (-962)
Satin Etched Glass

Bronze (-710)
Etched White Glass

EN* DAMP T24-1 T24-2 50 LB +



Large
Nine Light
Chandelier



Medium
Five Light
Chandelier



Small
Three Light
Chandelier



Medium
Three Light
Lantern



One Light
Mini-Pendant



Extra Large
Three Light
Pendant



Large Three Light
Semi-Flush
Convertible
Pendant



Four Light
Wall / Bath



Three Light
Wall / Bath



Two Light
Wall / Bath



One Light
Wall / Bath
Sconce

HETTINGER

p.500

FINISHES | MATERIALS

Chrome (-05) (Wall / Bath Only)
Etched White Glass

Brushed Nickel (-962)
Etched White Glass

Bronze (-710)
Etched White Glass

Satin Brass (-848) (Wall / Bath Only)
Etched White Glass

Midnight Black (-112) (Wall / Bath Only)
Etched White Glass

EN* DAMP T24-1 T24-2 +



Large Nine Light
Chandelier



Medium Six Light
Chandelier



Extra Large
Three Light
Pendant



One Light
Mini-Pendant



Medium Two Light
Semi-Flush
Convertible
Pendant



Four Light
Wall / Bath



Three Light
Wall / Bath



Two Light
Wall / Bath



One Light
Wall / Bath
Sconce

KEMAL

p.496

FINISHES | MATERIALS

- Brushed Nickel (-962)
Etched, White Inside Glass
- Bronze (-710)
Satin Etched Glass
- Midnight Black (-112)
Etched, White Inside Glass

EN ★ DAMP T24-1 T24-2 +



Large
Nine Light
Chandelier



Medium
Five Light
Chandelier



Small
Three Light
Chandelier



Large
Three Light
Uplight Pendant



Large
Semi-Flush
Mount



Four Light
Wall / Bath



Three Light
Wall / Bath



Two Light
Wall / Bath



One Light
Wall / Bath
Sconce

KERRVILLE

p.484

FINISHES | MATERIALS

- Chrome (-05)
Satin Etched Glass
- Brushed Nickel (-962)
Satin Etched Glass
- Bronze (-710)
Satin Etched Glass

EN ★ DAMP T24-1 T24-2 +



Large
Nine Light
Chandelier



Medium
Five Light
Chandelier



Small
Three Light
Chandelier



Extra Large
Three Light
Pendant



Large
One Light
Pendant



One Light
Mini-Pendant



Two Light
Semi-Flush
Convertible
Pendant



Four Light
Wall / Bath



Three Light
Wall / Bath



Two Light
Wall / Bath



One Light
Wall / Bath
Sconce

OSLO

p.468

FINISHES | MATERIALS

- Chrome (-05) Cased Opal Etched Glass or Clear Seeded Glass
- Brushed Nickel (-962) Cased Opal Etched Glass or Clear Seeded Glass
- Bronze (-710) Clear Seeded Glass
- Midnight Black (-112) Cased Opal Etched Glass or Clear Seeded Glass

EN * DAMP T24-1 T24-2 +



Large
Nine Light
Chandelier



Medium
Five Light
Chandelier



Small
Three Light
Chandelier



Medium
Three Light
Island Pendant



One Light
Mini-Pendant



Medium
One Light
Pendant



Medium Two Light
Semi-Flush
Convertible
Pendant



Four Light
Wall / Bath



Three Light
Wall / Bath



Two Light
Wall / Bath



One Light
Wall / Bath
Sconce

ROBIE

p.510

FINISHES | MATERIALS

- Chrome (-05) (Wall / Bath Only) Etched, White Inside Glass
- Brushed Nickel (-962) Etched, White Inside Glass
- Bronze (-710) Etched, White Inside Glass
- Midnight Black (-112) Etched, White Inside Glass

EN * DAMP T24-1 T24-2 +



Extra Large
Twelve Light
Chandelier



Large
Nine Light
Chandelier



Medium
Five Light
Chandelier



Small
Three Light
Chandelier



One Light
Mini-Pendant



Large
Three Light
Uplight
Pendant



Large
Three Light
Semi-Flush
Mount



Four Light
Wall / Bath



Three Light
Wall / Bath



Two Light
Wall / Bath



One Light
Wall / Bath
Sconce

SEVILLE

p.474

FINISHES | MATERIALS

- Chrome (-05) (Wall / Bath Only)
Etched White Glass
- Brushed Nickel (-962)
Etched White Glass
- Bronze (-710)
Etched White Glass

EN ★ DAMP T24-1 T24-2 +



Large
Nine Light
Chandelier



Medium
Five Light
Uplight
Chandelier



Medium
Five Light
Downlight
Chandelier



Small
Three Light
Chandelier



Medium
Five Light
Hanging Shade



Medium
Three Light
Pendant



One Light
Mini-Pendant



Small Two Light
Semi-Flush
Convertible Pendant



Five Light
Wall / Bath



Four Light
Wall / Bath



Three Light
Wall / Bath



Two Light
Wall / Bath



One Light
Wall / Bath
Sconce

WINDOM

p.480

FINISHES | MATERIALS

- Chrome (-05) (Wall / Bath Only)
Etched Opal Glass
- Brushed Nickel (-962)
Etched Opal Glass
- Satin Brass (-848)
Etched Opal Glass
- Bronze (-710)
Etched Opal Glass
- Midnight Black (-112)
Etched Opal Glass

EN ★ DAMP T24-1 T24-2 +



Large
Nine Light
Chandelier



Medium
Five Light
Chandelier



Small
Three Light
Chandelier



One Light
Mini-Pendant



Medium
Three Light
Pendant



Small Two Light
Semi-Flush
Convertible Pendant



Four Light
Wall / Bath



Three Light
Wall / Bath



Two Light
Wall / Bath



One Light
Wall / Bath
Sconce



PRODUCT SHOWN: PENDER MEDIUM TABLE LAMP
IN SATIN BRASS AND CLEAR GLASS FINISH

TABLE LAMPS



PRODUCT SHOWN: PENDER MEDIUM
TABLE LAMP IN SATIN BRASS FINISH

A. MEDIUM TABLE LAMP

DREW & JONATHAN

D: 14" H: 20.75"

6' of Wire

DJT1041(SB1 MBK1)

(1) LED Medium A19 9W Bulb lamp incl.
800 Lumens | 3000 K | 90+ CRI



A

Satin Brass Finish (SB1)
Clear Glass
White Linen Fabric Shade



Midnight Black Finish (MBK1)
Clear Glass
White Linen Fabric Shade

FINISH CODES

(SB1) Satin Brass

(MBK1) Midnight Black



PRODUCT SHOWN: PORTEAU MEDIUM TABLE LAMP IN MIDNIGHT BLACK FINISH

A. MEDIUM TABLE LAMP

DREW & JONATHAN

D: 11.75" H: 23"

6' of Wire

DJT1011S (SB1 MBK1)

(1) LED Medium A19 9W Bulb lamp incl.
800 Lumens | 3000 K | 90+ CRI



A

Satin Brass Finish (SB1)
White Linen Fabric Shade



Midnight Black Finish (MBK1)
White Linen Fabric Shade

FINISH CODE

(SB1) Satin Brass

(MBK1) Midnight Black



PRODUCT SHOWN: BINX MEDIUM TASK
TABLE LAMP IN MIDNIGHT BLACK FINISH

A. MEDIUM TASK TABLE LAMP

DREW & JONATHAN

D: 10.5" L: 5.75" H: 23"

6' of Wire

DJT1081(SB1 MBK1)

(1) LED Medium A19 9W Bulb lamp incl.

800 Lumens | 3000 K | 90+ CRI



A

Satin Brass Finish (SB1)
White Linen Fabric Shade



Midnight Black Finish (MBK1)
White Linen Fabric Shade

FINISH CODES

(SB1) Satin Brass

(MBK1) Midnight Black



PRODUCT SHOWN: BUCKLEY MEDIUM
TABLE LAMP IN GLOSS WHITE FINISH

A. MEDIUM TABLE LAMP

DREW & JONATHAN

D: 14.5" H: 27.38"

6' of Wire

DJT1051(GW1 GNV1 GBK1)

(1) LED Medium A19 9W Bulb lamp incl.
800 Lumens | 3000 K | 90+ CRI



A

Gloss White (GW1)
Satin Brass
White Linen Fabric Shade



Gloss Navy (GNV1)
Satin Brass
White Linen Fabric Shade



Gloss Black (GBK1)
Satin Brass
White Linen Fabric Shade

FINISH CODES

(GW1) Gloss White

(GNV1) Gloss Navy

(GBK1) Gloss Black



PRODUCT SHOWN: MORSBY MEDIUM
TABLE LAMP IN GLOSS WHITE FINISH

A. MEDIUM TABLE LAMP

DREW & JONATHAN

D: 12" H: 23.13"

6' of Wire

DJT1071(GW1 GNV1 GBK1)

(1) LED Medium A19

9W Bulb lamp incl.

800 Lumens | 3000 K | 90+ CRI



A

Gloss White (GW1)
Satin Brass
White Linen Fabric Shade



Gloss Navy (GNV1)
Satin Brass
White Linen Fabric Shade



Gloss Black (GBK1)
Satin Brass
White Linen Fabric Shade

FINISH CODES

(GW1) Gloss White

(GNV1) Gloss Navy

(GBK1) Gloss Black



PRODUCT SHOWN: FERNWOOD MEDIUM
TABLE LAMP IN GLOSS BLACK FINISH

A. MEDIUM TABLE LAMP

DREW & JONATHAN

D: 14" H: 26.5"

6' of Wire

DJT1061(GW1 GNV1 GBK1)

(1) LED Medium A19

9W Bulb lamp incl.

800 Lumens | 3000 K | 90+ CRI



A

Gloss White (GW1)
Satin Brass
White Linen Fabric Shade



Gloss Navy (GNV1)
Satin Brass
White Linen Fabric Shade



Gloss Black (GBK1)
Satin Brass
White Linen Fabric Shade

FINISH CODES

(GW1) Gloss White

(GNV1) Gloss Navy

(GBK1) Gloss Black



PRODUCT SHOWN: CAPALINO LARGE
CHANDELIER IN BRUSHED STEEL FINISH

CHANDELIERS



PRODUCT SHOWN: CAPALINO LARGE CHANDELIER IN SATIN BRASS FINISH

A. LARGE CHANDELIER

DREW & JONATHAN
W: 30" H: 19.63"
10' of Wire, (3) 12" Stems, (1) 6" Stem
DAMP

DJC1058(BS SB MBK)
(8) Candelabra Torpedo 60W max.

B. MEDIUM CHANDELIER

DREW & JONATHAN
W: 24" H: 19.63"
10' of Wire, (3) 12" Stems, (1) 6" Stem
DAMP

DJC1048(BS SB MBK)
(8) Candelabra Torpedo 60W max.



FINISH CODES
(BS) Brushed Steel
(SB) Satin Brass
(MBK) Midnight Black

A. EXTRA LARGE CHANDELIER

DREW & JONATHAN

D: 36" W: 36" H: 33"

10' of Chain

DAMP

DJC1099(BS SB MBK)

(9) Candelabra Torpedo

60W max.



A

Midnight Black Finish (MBK)
White Linen Fabric Shades



Satin Brass (SB)

White Linen Fabric Shades

FINISH CODES

(BS) Brushed Steel

(SB) Satin Brass

(MBK) Midnight Black

B. LARGE CHANDELIER

DREW & JONATHAN

D: 28" W: 28" H: 25"

6' of Chain

DAMP

DJC1086(BS SB MBK)

(6) Candelabra Torpedo

60W max.



B

Brushed Steel Finish (BS)
White Linen Fabric Shades



Midnight Black Finish (MBK)
White Linen Fabric Shades



Satin Brass Finish (SB)
White Linen Fabric Shades

FINISH CODES

(BS) Brushed Steel

(SB) Satin Brass

(MBK) Midnight Black



PRODUCT SHOWN: BURKE LARGE CHANDELIER IN SATIN BRASS FINISH

A. LARGE CHANDELIER

DREW & JONATHAN
 W: 38" H: 12"
 10' of Wire, (3) 12" Stems, (1) 6" Stem
 DAMP

DJC1016(BS SB MBK)
 (6) Candelabra Torpedo 60W max.

B. MEDIUM CHANDELIER

DREW & JONATHAN
 W: 30" H: 12"
 10' of Wire, (3) 12" Stems, (1) 6" Stem
 DAMP

DJC1005(BS SB MBK)
 (5) Candelabra Torpedo 60W max.



A

Satin Brass Finish (SB)
 White Linen Fabric Shades

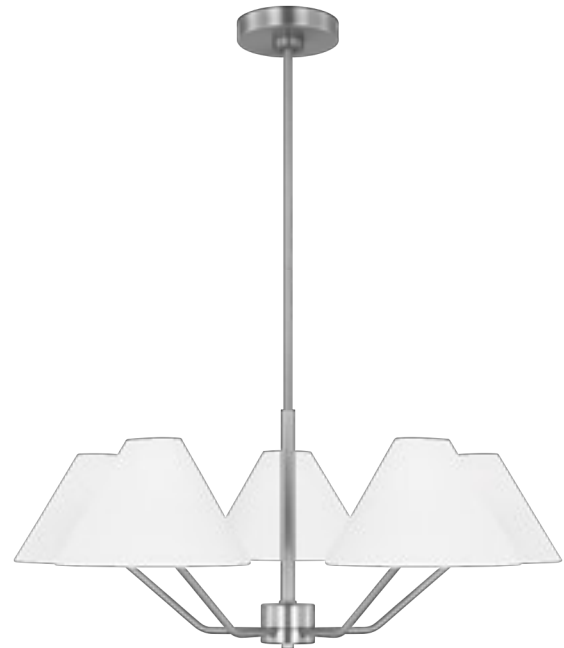

B

Brushed Steel Finish (BS)
 White Linen Fabric Shades



Midnight Black Finish (MBK)
 White Linen Fabric Shades

FINISH CODES

- (BS) Brushed Steel
- (SB) Satin Brass
- (MBK) Midnight Black

A. MEDIUM FIVE LIGHT CHANDELIER

D: 25.25" H: 17.75"
10' of Wire pre-laced through 3' of Chain

3140405(-848 -962)

(5) Medium A19 75W max.

T24-1

3140405EN3(-848 -962)

(3) LED Medium A19 9W Bulbs lamps incl.

T24-2 EN*

B. SMALL THREE LIGHT CHANDELIER

D: 20.5" H: 16.75"
10' of Wire pre-laced through 3' of Chain

3140403(-848 -962)

(3) Medium A19 75W max.

T24-1

3140403EN3(-848 -962)

(3) LED Medium A19 9W Bulbs lamps incl.

T24-2 EN*

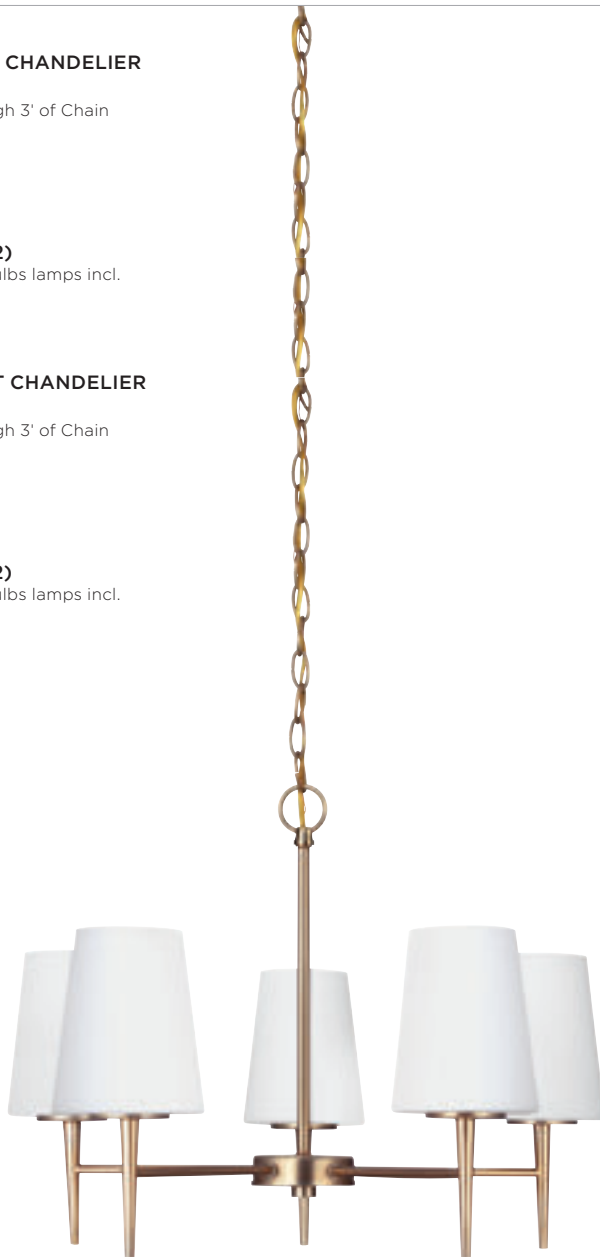

A

Satin Brass Finish (-848)
Opal Etched Glass



B

Brushed Nickel Finish (-962)
Opal Etched Glass

FINISH CODES

(-848) Satin Brass

(-962) Brushed Nickel

A. LARGE CHANDELIER

DREW & JONATHAN
W: 38" H: 24.5"
10' of Wire, (3) 12" Stems, (1) 6" Stem
DAMP

DJC1035(SB MBK)
(5) Candelabra Torpedo 60W max.

B. MEDIUM CHANDELIER

DREW & JONATHAN
W: 30" H: 23"
10' of Wire, (3) 12" Stems, (1) 6" Stem
DAMP

DJC1024(SB MBK)
(4) Candelabra Torpedo 60W max.



A

Midnight Black Finish (MBK)
White Linen Fabric Shades



B

Satin Brass Finish (SB)
White Linen Fabric Shades

FINISH CODES

(SB) Satin Brass
(MBK) Midnight Black



PRODUCT SHOWN: TOWNER FIVE LIGHT
CHANDELIER IN SATIN BRASS FINISH

A. LARGE SEVEN LIGHT CHANDELIER

D: 35" H: 27.75"
 10' Wire, (3) 12" Stems, (1) 6" Stem
 Sloped Ceiling Mounting Hardware incl.
 DAMP

3141307(-848 -962)
 (7) Medium Base 60W max.
 T24-1

3141307EN3(-848 -962)
 (7) Med. Base LED 3000K,
 9W, 800 Lumen lamps incl.
 T24-2 EN*



A

Satin Brass Finish (-848) with
 Midnight Black (-112) Shades

B. MEDIUM FIVE LIGHT CHANDELIER

D: 29" H: 24.75"
 10' Wire, (3) 12" Stems, (1) 6" Stem
 Sloped Ceiling Mounting Hardware incl.
 DAMP

3141305(-848 -962)
 (5) Medium Base 60W max.
 T24-1

3141305EN3(-848 -962)
 (5) Med. Base LED 3000K,
 9W, 800 Lumen lamps incl.
 T24-2 EN*

C. SMALL THREE LIGHT CHANDELIER

D: 24" H: 22"
 10' Wire, (3) 12" Stems, (1) 6" Stem
 Sloped Ceiling Mounting Hardware incl.
 DAMP

3141303-848
 (3) Medium Base 60W max.
 T24-1

3141303EN3-848
 (3) Med. Base LED 3000K,
 9W, 800 Lumen lamps incl.
 T24-2 EN*



B

Brushed Nickel Finish (-962) with
 Midnight Black (-112) Shades



C

Satin Brass Finish (-848) with
 Midnight Black (-112) Shades

FINISH CODES

(-848) Satin Brass
 (-962) Brushed Nickel



PRODUCT SHOWN: HADDEN LARGE
CHANDELIER IN MIDNIGHT BLACK FINISH

A. LARGE CHANDELIER

DREW & JONATHAN
 L: 27.13" W: 36" H: 24.25"
 10' of Wire, (3) 12" Stems, (1) 6" Stem
 Adjustable arm rotation

DAMP

DJC1126(SB MBK)

(6) Candelabra T6 Tubular 40W max.

B. MEDIUM CHANDELIER

DREW & JONATHAN
 L: 17.5" W: 27.13" H: 17.25"
 10' of Wire, (3) 12" Stems, (1) 6" Stem
 Adjustable arm rotation

DAMP

DJC1104(SB MBK)

(4) Candelabra T6 Tubular 40W max.

C. SMALL CHANDELIER

DREW & JONATHAN
 L: 14.25" W: 22" H: 14.13"
 10' of Wire, (3) 12" Stems, (1) 6" Stem
 Adjustable arm rotation

DAMP

DJC1114(SB MBK)

(4) Candelabra T6 Tubular 40W max.



A

Satin Brass Finish (SB)



B

Midnight Black Finish (MBK)



C

Satin Brass Finish (SB)

FINISH CODES

(SB) Satin Brass
 (MBK) Midnight Black



PRODUCT SHOWN: ALTURAS NINE LIGHT CHANDELIER IN SATIN BRASS FINISH

A. LARGE NINE LIGHT CHANDELIER

D: 32.5" H: 32.75"
 12' Wire, (3) 12" Stems, (1) 6" Stem
 Sloped Ceiling Mounting Hardware incl.

DAMP

3124609(-848 -962 -112)

(9) Medium Base 60W max.

T24-1

3124609EN3(-848 -962 -112)

(9) Med. Base LED 3000K,
 9W, 800 Lumen lamps incl.

T24-2 EN*



A

Midnight Black Finish (-112)
 Opal Etched Glass Shades

B. MEDIUM FIVE LIGHT CHANDELIER

D: 27.25" H: 27"
 12' Wire, (3) 12" Stems, (1) 6" Stem
 Sloped Ceiling Mounting Hardware incl.

DAMP

3124605(-848 -962 -112)

(5) Medium Base 75W max.

T24-1

3124605EN3(-848 -962 -112)

(5) Med. Base LED 3000K,
 9W, 800 Lumen lamps incl.

T24-2 EN*

C. SMALL THREE LIGHT CHANDELIER

D: 19" H: 18.75"
 12' Wire, (3) 12" Stems, (1) 6" Stem
 Sloped Ceiling Mounting Hardware incl.

DAMP

3124603(-848 -962 -112)

(3) Medium Base 75W max.

T24-1

3124603EN3(-848 -962 -112)

(3) Med. Base LED 3000K,
 9W, 800 Lumen lamps incl.

T24-2 EN*



B

Brushed Nickel Finish (-962)
 Opal Etched Glass Shades



C

Satin Brass Finish (-848)
 Opal Etched Glass Shades

FINISH CODES

- (-962) Brushed Nickel
- (-112) Midnight Black
- (-848) Satin Brass

D. LARGE NINE LIGHT CHANDELIER

D: 32.5" H: 32.75"
12' Wire, (3) 12" Stems, (1) 6" Stem

DAMP

3124679(-112 -848 -962)

(9) Medium Base 60W max.

T24-1

3124679EN7(-112 -848 -962)

(9) Med. Base LED 2700K,
8W, 800 Lumens lamps incl.

T24-2



D

Midnight Black Finish (-112)
Clear Seeded Glass Shades



Satin Brass Finish (-848)
Clear Seeded Glass Shades

FINISH CODES

- (-112) Midnight Black
- (-848) Satin Brass
- (-962) Brushed Nickel

E. MEDIUM FIVE LIGHT CHANDELIER

D: 27.25" H: 27"
 12' Wire, (3) 12" Stems, (1) 6" Stem
 DAMP

3124675(-112 -848 -962)

(5) Medium Base 75W max.
 T24-1

3124675EN7(-112 -778 -848 -962)

(5) Med. Base LED 2700K,
 8W, 800 Lumens lamps incl.
 T24-2 EN*



E

Midnight Black Finish (-112)
 Clear Seeded Glass Shades

F. SMALL THREE LIGHT CHANDELIER

D: 19" H: 18.75"
 12' Wire, (3) 12" Stems, (1) 6" Stem
 DAMP

3124673(-112 -848 -962)

(3) Medium Base 75W max.
 T24-1

3124673EN7(-112 -848 -962)

(3) Med. Base LED 2700K,
 8W, 800 Lumens lamps incl.
 T24-2 EN*



F

Brushed Nickel Finish (-962)
 Clear Seeded Glass Shades



Satin Brass Finish (-848)
 Clear Seeded Glass Shades

FINISH CODES

- (-112) Midnight Black
- (-848) Satin Brass
- (-962) Brushed Nickel



PRODUCT SHOWN: ANSLEY MEDIUM
CHANDELIER IN AGED IRON FINISH

A. LARGE CHANDELIER

D: 44" H: 35.75"
 20' Wire, (4) 12" Stems,
 (1) 6" Stem

F3290/12AI

(12) Candelabra Torpedo
 60W max.

B. MEDIUM CHANDELIER

D: 32" H: 19.125"
 15' Wire, (4) 12" Stems,
 (1) 6" Stem

F3291/8AI

(8) Candelabra Torpedo Base
 60W max.



A

Aged Iron Finish (AI)



B

Aged Iron Finish (AI)

FINISH CODE

(AI) Aged Iron

A. LARGE CHANDELIER

D: 24" H: 28.625"
15' Wire, (4) 12" Stems, (1) 6" Stem

F3341/8AI/ADB

(8) Candelabra Torpedo 60W max.

DAMP

B. MEDIUM CHANDELIER

D: 30" H: 25.625"
15' Wire, (4) 12" Stems, (1) 6" Stem

F3340/5AI/ADB

(5) Candelabra Torpedo 60W max.

DAMP



A

Aged Iron / Antique Gild (AI/ADB)



B

Aged Iron / Antique Gild (AI/ADB)

FINISH CODE

(AI/ADB) Aged Iron/Antique Gild

A. MEDIUM CHANDELIER

D: 28.625" H: 35"
15' Wire, 5' Chain

F3169/5DWI

(5) Medium A19 60W max.

DAMP



A

Dark Weathered Iron Finish (DWI)
Clear Seeded Glass

FINISH CODE

(DWI) Dark Weathered Iron

A. LARGE NINE LIGHT CHANDELIER

D: 31" H: 23"
12' Wire pre-laced through 10' Chain

DAMP

3110209-846

(9) Medium Base 60W max.

T24-1

B. MEDIUM FIVE LIGHT CHANDELIER

D: 25" H: 21.75"
12' Wire pre-laced through 10' Chain

DAMP

3110205-846

(5) Medium Base 60W max.

T24-1



A

Stardust Finish (-846)



B

Stardust Finish (-846)

FINISH CODE

(-846) Stardust

A. LARGE TWO-TIER CHANDELIER

D: 30" H: 33.5"
 15' Wire, (4) 12" Stems,
 (1) 6" Stem

F2987/9SN/CH
 (9) Halogen G9 T4 40W max.
 Bulbs incl..

B. MEDIUM CHANDELIER

D: 25.375" H: 26.375"
 15' Wire, (4) 12" Stems,
 (1) 6" Stem

F2985/6SN/CH
 (6) Halogen G9 T4 40W max.
 Bulbs incl.



A

Satin Nickel / Chrome Finish (SN/CH)
 White Opal Etched Glass



B

Satin Nickel / Chrome Finish (SN/CH)
 White Opal Etched Glass

FINISH CODE

(SN/CH) Satin Nickel / Chrome

A. LARGE CHANDELIER

D: 41.125" H: 46.125"
15' Wire, (4) 12" Stems,
(1) 6" Stem

F3281/12ADB

(12) Candelabra Torpedo
60W max.

DAMP

B. MEDIUM CHANDELIER

D: 25.375" H: 26.375"
15' Wire, (4) 12" Stems,
(1) 6" Stem

F3280/8ADB

(8) Candelabra Torpedo
60W max.

DAMP



A

Antique Gild Finish (ADB)



B

Antique Gild Finish (ADB)

FINISH CODE

(ADB) Antique Gild

A. MEDIUM CHANDELIER

D: 28.5" H: 32.75"
15' Wire, 5' Chain

F2478/6OBZ

(6) Candelabra Flame Tip
60W max.



A

Oxidized Bronze Finish (OBZ)

FINISH CODE

(OBZ) Oxidized Bronze

A. EXTRA LARGE CHANDELIER

D: 53.5" H: 69"
20' Wire, 7' Chain

F2110/8+4+4MBZ

(16) Candelabra Torpedo Base
60W max.



A

Mocha Bronze Finish (MBZ)

FINISH CODE

(MBZ) Mocha Bronze

B. LARGE CHANDELIER

D: 36" H: 47"
20' Wire, 7' Chain

F1938/8+4MBZ

(12) Candelabra B Torpedo Base
60W max.

C. MEDIUM CHANDELIER

D: 32" H: 37.5"
15' Wire, 5' Chain

F2303/8MBZ

(8) Candelabra B Torpedo Base
60W max.

D. SMALL CHANDELIER

D: 25" H: 30"
15' Wire, 5' Chain

F1902/6MBZ

(6) Candelabra Flame Tip
60W max.



B

Mocha Bronze Finish (MBZ)



C

Mocha Bronze Finish (MBZ)



D

Mocha Bronze Finish (MBZ)

FINISH CODE

(MBZ) Mocha Bronze

A. EXTRA LARGE CHANDELIER

D: 30" H: 26.625"
25' Wire, (3) 12" Stems, (1) 6" Stem

F2629/8+4AF/BS

(12) Candelabra B Torpedo Base 60W max.



A

Antique Forged Iron/Brushed Steel Finish (AF/BS)
Clear Glass

FINISH CODE

(AF/BS) Antique Forged Iron/Brushed Steel

A. EXTRA LARGE SIX LIGHT CHANDELIER

D: 40" H: 31.25"
12' of Wire pre-laced through 10' of Chain
DAMP

3224906-846
(6) Candelabra Torpedo 60W max.
T24-1

3224906EN-846
(6) LED Candelabra Torpedo
3.5W Bulbs lamps incl.
T24-2 EN*



A

Stardust Finish (-846)

B. LARGE SIX LIGHT CHANDELIER

D: 26" H: 22"
12' of Wire pre-laced through 10' of Chain
DAMP

3124906-846
(6) Candelabra Torpedo 60W max.
T24-1

3124906EN-846
(6) LED Candelabra Torpedo
3.5W Bulbs lamps incl.
T24-2 EN*

C. MEDIUM FOUR LIGHT CHANDELIER

D: 22" H: 18.375"
12' of Wire pre-laced through 10' of Chain
DAMP

3124904-846
(4) Candelabra Torpedo 60W max.
T24-1

3124904EN-846
(3) LED Candelabra Torpedo
3.5W Bulbs lamps incl.
T24-2 EN*



B

Stardust Finish (-846)



C

Stardust Finish (-846)

FINISH CODE

(-846) Stardust



PRODUCT SHOWN: BELTON MEDIUM FOUR LIGHT
LINEAR CHANDELIER IN BRUSHED NICKEL FINISH

LINEAR



PRODUCT SHOWN: BELTON MEDIUM FOUR LIGHT
LINEAR CHANDELIER IN BRONZE FINISH

**A. MEDIUM FOUR LIGHT
LINEAR CHANDELIER**

L: 40.75" W: 5.5" H: 15"
6' Wire, (3) 12" Stems, (1) 6" Stem

6614504(-962 -710 -112)

(4) Medium Base 60W max.

T24-1

6614504EN7(-962 -710 -112)

(4) Med. Base LED 2700K,
8W, 800 Lumen lamps incl.

T24-1 EN*



A

Brushed Nickel Finish (-962)
Clear Seeded Glass



Midnight Black Finish (-112)
Clear Seeded Glass



Bronze Finish (-710)
Clear Seeded Glass

FINISH CODES

(-962) Brushed Nickel

(-710) Bronze

(-112) Midnight Black

**A. MEDIUM THREE LIGHT
LINEAR CHANDELIER**

L: 25.25" W: 4" H: 9.5"
12' Wire, (6) 12" Stems, (2) 6" Stems

66160(-05 -962 -112)

(3) Medium Base 75W max.

T24-1

66160EN3(-05 -962 -112)

(3) Med. Base LED 3000K,
9W, 800 Lumen lamps incl.

T24-1 EN *



A

Midnight Black Finish (-112)
Cased Opal Etched Glass



Brushed Nickel Finish (-962)
Cased Opal Etched Glass



Chrome Finish (-05)
Cased Opal Etched Glass

FINISH CODES

- (-05) Chrome
- (-962) Brushed Nickel
- (-112) Midnight Black

A. MEDIUM LINEAR CHANDELIER

L: 38" W: 9" H: 9"
Supplied with 15' of Wire,
(8) 12" Stems, (2) 6" Stems

DAMP

F2986/8SN/CH

(8) G9 40W max. Bulbs incl.



A

Satin Nickel / Chrome Finish (SN/CH)
White Opal Etched Glass

FINISH CODE

(SN/CH) Satin Nickel / Chrome

ELMWOOD PARK LINEAR



PRODUCT SHOWN: ELMWOOD PARK MEDIUM FOUR LIGHT
LINEAR CHANDELIER IN BRUSHED NICKEL FINISH

**A. MEDIUM FOUR LIGHT
LINEAR CHANDELIER**

L: 40" W: 4.375" H: 24.75"
Supplied with 6' of Wire,
(3) 12" Stems, (1) 6" Stem

DAMP

6637304(-962 -710)

(4) Medium Base 75W max.

T24-1

6637304EN3(-962 -710)

(4) Med. Base LED 3000K,
9W, 800 Lumen lamps incl.

T24-1 EN*



A

Brushed Nickel Finish (-962)
Satin Etched Inner Glass, Clear Outer Glass



Bronze Finish (-710)
Satin Etched Inner Glass, Clear Outer Glass

FINISH CODES

- (-962) Brushed Nickel
- (-710) Bronze

**A. LARGE SEVEN LIGHT
LINEAR LANTERN**

L: 54" W: 12" H: 15"
Supplied with 10' of Wire,
(6) 12" Stems, (2) 6" Stems

DAMP

6634507(-848 -962 -872 -710)

(7) Candelabra Base 60W max.

T24-1

6634507EN(-848 -962 -872 -710)

(7) Cand. Base LED 2700K,
3.5W, 350 Lumen lamps incl.

T24-1 EN*

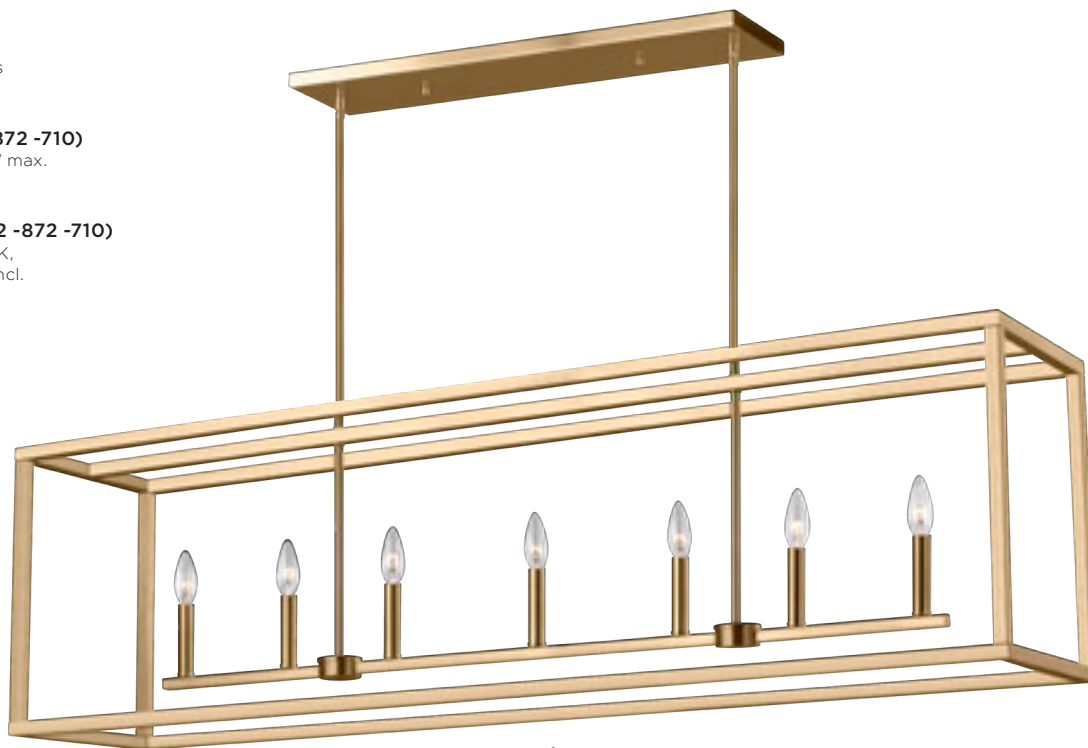

A

Satin Brass Finish (-848)



Bronze Finish (-710)

FINISH CODES

- (-848) Satin Brass
- (-962) Brushed Nickel
- (-872) Washed Pine with Chrome Accents
- (-710) Bronze

**B. MEDIUM SIX LIGHT
LINEAR LANTERN**

L: 42" W: 12" H: 15"
10' of Wire, (6) 12" Stems, (2) 6" Stems

DAMP

6634506(-848 -962 -872 -710)

(6) Candelabra Base 60W max.

T24-1

6634506EN(-848 -962 -872 -710)

(6) Cand. Base LED 2700K,
3.5W, 350 Lumen lamps incl.

T24-1 EN *

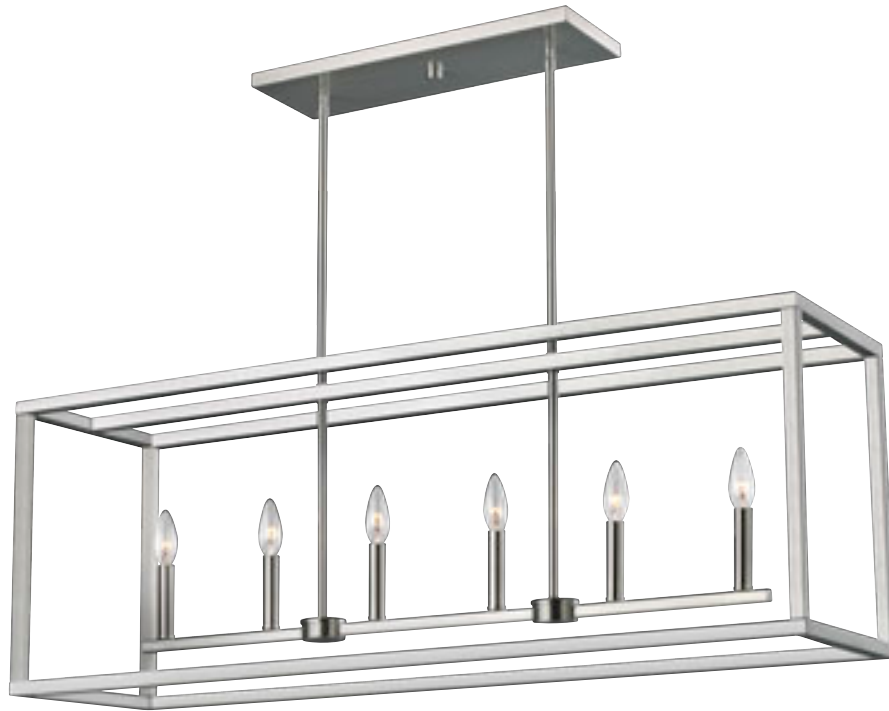

B

Brushed Nickel Finish (-962)



Washed Pine Finish (-872)
with Chrome Accents

FINISH CODES

- (-848) Satin Brass
- (-962) Brushed Nickel
- (-872) Washed Pine with Chrome Accents
- (-710) Bronze

**A. MEDIUM EIGHT LIGHT
LINEAR LANTERN**

L: 40" W: 12" H: 16.75"
10' Wire, (6) 12" Stems, (2) 6" Stems

DAMP

6615008(-848 -05 -710 -112)

(8) Candelabra Base 60W max.

T24-1

6615008EN(-848 -05 -710 -112)

(8) Cand. Base LED 2700K,
3.5W, 350 Lumen lamps incl.

T24-1

EN *



A

Satin Brass Finish (-848)
Satin Brass Candle Holders



Chrome Finish (-05)
Cream Candle Holders

**FINISH CODES AND
INCLUDED CANDLE HOLDERS**

- (-848) Satin Brass Finish
Satin Brass and Cream Candle Holders
- (-05) Chrome
Chrome and Cream Candle Holders
- (-710) Bronze
Bronze and Satin Brass Candle Holders
- (-112) Midnight Black
Midnight Black and Chrome Candle Holders



Bronze Finish (-710)
Satin Brass Candle Holders

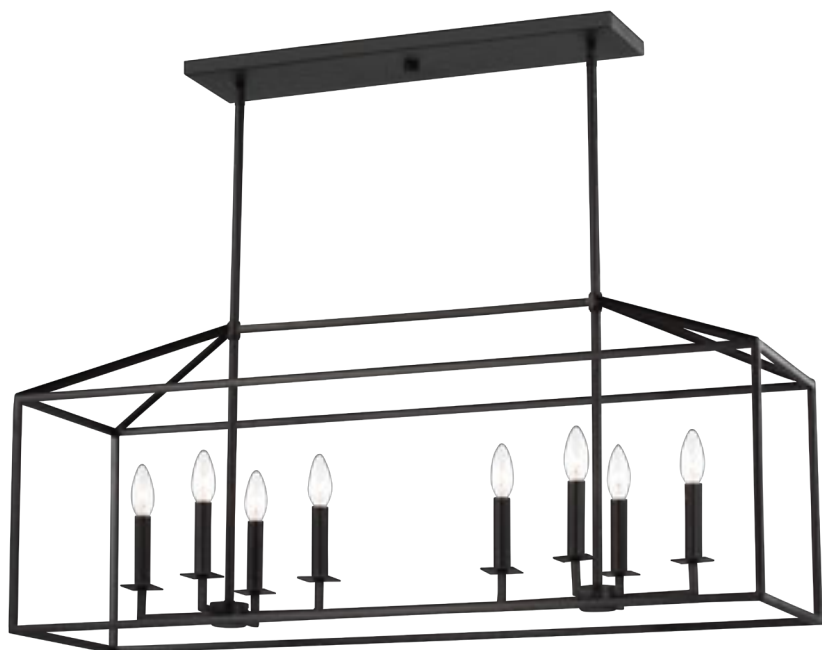

Midnight Black Finish (-112)
Midnight Black Candle Holders

FINISH CODES AND INCLUDED CANDLE HOLDERS

- (-848) Satin Brass Finish
Satin Brass and Cream Candle Holders
- (-05) Chrome
Chrome and Cream Candle Holders
- (-710) Bronze
Bronze and Satin Brass Candle Holders
- (-112) Midnight Black
Midnight Black and Chrome Candle Holders



PRODUCT SHOWN: MITTE MEDIUM
FOUR LIGHT LINEAR LANTERN IN
MIDNIGHT BLACK FINISH

**A. MEDIUM FOUR LIGHT
LINEAR LANTERN**

L: 40" W: 12" H: 14.625"
Supplied with 15' of Wire
(8) 12" Stems, (2) 6" Stems

DAMP

6641504-112

(4) Medium Base 75W max.

T24-1

6641504EN7-112

(4) Med. Base LED 2700K,
8W, 800 Lumen lamps incl.

T24-1 EN*



A

Midnight Black Finish (-112)

FINISH CODE

(-112) Midnight Black

A. LARGE LINEAR CHANDELIER

L: 48" W: 14.625" H: 22"

15' of Wire, (4) 12" Stems,

(1) 6" Stem

DAMP

F3292/8AI

(8) Candelabra Torpedo Base 60W max.



A

Aged Iron Finish (AI)

FINISH CODE

(AI) Aged Iron

A. SMALL EIGHT LIGHT LINEAR CHANDELIER

L: 34" W: 12" H: 8"
10' Wire, (6) 12" Stems, (2) 6" Stems

DAMP

3110208-846

(8) Medium Base 60W max.

T24-1



A

Stardust Finish (-846)

FINISH CODE

(-846) Stardust

A. MEDIUM LINEAR CHANDELIER

L: 37.5" W: 10" H: 19.875"
15' of Wire, (6) 12" Stems,
(2) 6" Stems

F2630/8AF/BS

(8) Candelabra Base 60W max.



A

Antique Forged Iron/Brushed Steel Finish (AF/BS)
Clear Glass

FINISH CODE

(AF/BS) Antique Forged Iron/Brushed Steel

**A. MEDIUM FOUR LIGHT
LINEAR PENDANT**

L: 36" W: 11" H: 24.875"
10' Wire, (6) 12" Stems, (2) 6" Stems

6613304-846

(4) Med. Base 75W max.

T24-1 EN *

6613304EN3-846

(4) Med. Base LED 3000K,
9W, 800 Lumen lamps incl.

T24-1 EN *



A

Stardust Finish (-846)
Creme Parchment Glass

FINISH CODE

(-846) Stardust



PRODUCT SHOWN: PERRYTON LARGE
EIGHT LIGHT LANTERN IN MIDNIGHT BLACK
FINISH AND CHROME CANDLE HOLDERS

LANTERNS

A. EXTRA LARGE EIGHT LIGHT LANTERN

L: 22" W: 22" H: 38"
 10' of Wire, (3) 12" Stems, (1) 6" Stem
 Sloped Ceiling Mounting Hardware incl.

DAMP

5315008(-848 -05 -710 -112)

(8) Candelabra Torpedo 60W max.

T24-1

5315008EN(-848 -05 -710 -112)

(8) Cand. Base LED 2700K,
 3.5W, 350 Lumen lamps incl.

T24-2 EN*

B. LARGE EIGHT LIGHT LANTERN

L: 19" W: 19" H: 30.75"
 10' Wire, (3) 12" Stems, (1) 6" Stem
 Sloped Ceiling Mounting Hardware incl.

DAMP

5115008(-848 -05 -710 -112)

(8) Candelabra Base 60W max.

T24-1

5115008EN(-848 -05 -710 -112)

(8) Cand. Base LED 2700K,
 3.5W, 350 Lumen lamps incl.

T24-2 EN*

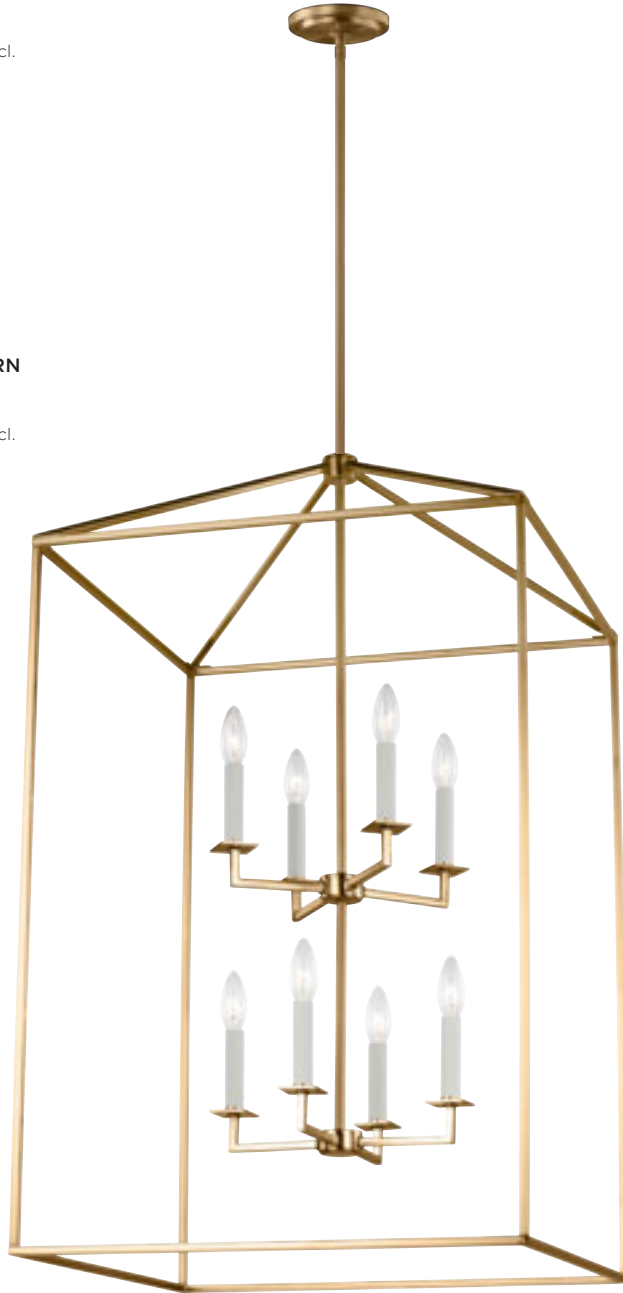

A

Satin Brass Finish (-848)
 Cream Candle Holders



B

Midnight Black Finish (-112)
 Midnight Black Candle Holders

FINISH CODES AND INCLUDED CANDLE HOLDERS

- (-848) Satin Brass Finish
 Satin Brass and Cream Candle Holders
- (-05) Chrome
 Chrome and Cream Candle Holders
- (-710) Bronze
 Bronze and Satin Brass Candle Holders
- (-112) Midnight Black
 Midnight Black and Chrome Candle Holders

C. MEDIUM FOUR LIGHT LANTERN

L: 15.5" W: 15.5" H: 23.25"
 10' Wire, (3) 12" Stems, (1) 6" Stem
 Sloped Ceiling Mounting Hardware incl.
 DAMP

5115004(-848 -05 -710 -112)

(4) Candelabra Base 60W max.
 T24-1

5115004EN(-848 -05 -710 -112)

(4) Cand. Base LED 2700K,
 3.5W, 350 Lumen lamps incl.
 T24-2 EN*



C

Satin Brass Finish (-848)
 Satin Brass Candle Holders



Bronze Finish (-710)
 Satin Brass Candle Holders

D. SMALL FOUR LIGHT LANTERN

L: 12.25" W: 12.25" H: 18.5"
 10' Wire, (3) 12" Stems, (1) 6" Stem
 Sloped Ceiling Mounting Hardware incl.
 DAMP

5215004(-848 -05 -710 -112)

(4) Candelabra Base 60W max.
 T24-1

5215004EN(-848 -05 -710 -112)

(4) Cand. Base LED 2700K,
 3.5W, 350 Lumen lamps incl.
 T24-2 EN*



D

Chrome Finish (-848)
 Cream Candle Holders



Midnight Black Finish (-112)
 Chrome Candle Holders

FINISH CODES AND INCLUDED CANDLE HOLDERS

- (-848) Satin Brass Finish
 Satin Brass and Cream Candle Holders
- (-05) Chrome
 Chrome and Cream Candle Holders
- (-710) Bronze
 Bronze and Satin Brass Candle Holders
- (-112) Midnight Black
 Midnight Black and Chrome Candle Holders

A. EXTRA LARGE EIGHT LIGHT LANTERN

L: 23.5" W: 23.5" H: 46"
 10' of Wire, (3) 12" Stems, (1) 6" Stem
 Sloped Ceiling Mounting Hardware incl.

DAMP

5234508(-848 -962 -872 -710)

(8) Candelabra Torpedo 60W max.

T24-1

5234508EN(-848 -962 -872 -710)

(8) Cand. Base LED 2700K,
 3.5W, 350 Lumen lamps incl.

T24-2

EN *

B. LARGE EIGHT LIGHT LANTERN

L: 19" W: 19" H: 31.125"
 10' of Wire, (3) 12" Stems, (1) 6" Stem
 Sloped Ceiling Mounting Hardware incl.

DAMP

5134508(-848 -962 -872 -710)

(8) Candelabra Base 60W max.

T24-1

5134508EN(-848 -962 -872 -710)

(8) Cand. Base LED 2700K,
 3.5W, 350 Lumen lamps incl.

T24-2

EN *



A

Satin Brass Finish (-848)



B

Bronze Finish (-710)

FINISH CODES

- (-848) Satin Brass
- (-962) Brushed Nickel
- (-872) Washed Pine with Chrome Accents
- (-710) Bronze

C. MEDIUM FOUR LIGHT LANTERN

L: 15.5" W: 15.5" H: 23.125"
 10' of Wire, (3) 12" Stems, (1) 6" Stem
 Sloped Ceiling Mounting Hardware incl.

DAMP

5134504(-848 -962 -872 -710)

(4) Candelabra Base 60W max.

T24-1

5134504EN(-848 -962 -872 -710)

(4) Cand. Base LED 2700K,
 3.5W, 350 Lumen lamps incl.

T24-2 EN*

D. SMALL THREE LIGHT LANTERN

L: 10.5" W: 10.5" H: 15"
 10' of Wire, (3) 12" Stems, (1) 6" Stem
 Sloped Ceiling Mounting Hardware incl.

DAMP

5134503(-848 -962 -872 -710)

(3) Candelabra Base 60W max.

T24-1

5134503EN(-848 -962 -872 -710)

(3) Cand. Base LED 2700K,
 3.5W, 350 Lumen lamps incl.

T24-2 EN*

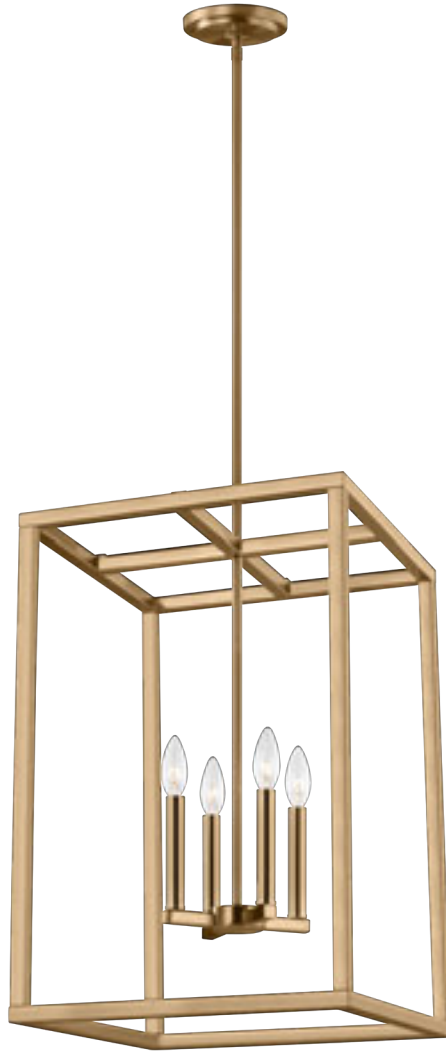

C

Satin Brass Finish (-848)

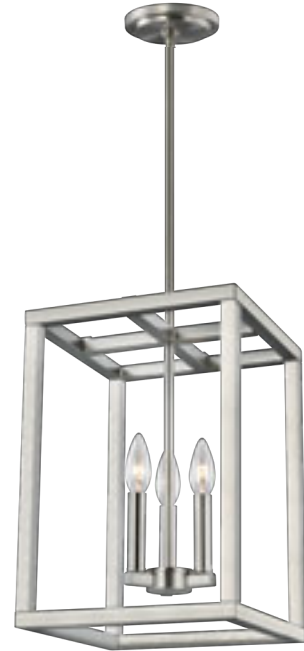

D

Brushed Nickel Finish (-962)



Washed Pine Finish (-872)
 with Chrome Accents

FINISH CODES

- (-848) Satin Brass
- (-962) Brushed Nickel
- (-872) Washed Pine with Chrome Accents
- (-710) Bronze

MITTE LANTERNS



PRODUCT SHOWN: MITTE FOUR LIGHT
LARGE LANTERN IN MIDNIGHT BLACK

A. LARGE FOUR LIGHT LANTERN

L: 27" W: 27" H: 36.125"
 Supplied with 15' of Wire
 (4) 12" Stems, (1) 6" Stem

DAMP

5341504-112

(4) Medium Base 75W max.

T24-1

5341504EN7-112

(4) Med. Base LED 2700K,
 8W, 800 Lumen lamps incl.

T24-2 EN*

B. SMALL FOUR LIGHT LANTERN

L: 21" W: 21" H: 27.25"
 Supplied with 15' of Wire
 (4) 12" Stems, (1) 6" Stem

DAMP

5241504-112

(4) Medium Base 75W max.

T24-1

5241504EN7-112

(4) Med. Base LED 2700K,
 8W, 800 Lumen lamps incl.

T24-2 EN*

C. LARGE ONE LIGHT PENDANT

L: 16.5" W: 16.5" H: 19.25"
 Supplied with 15' of Wire
 (4) 12" Stems, (1) 6" Stem

DAMP

5141501-112

(1) Medium Base 75W max.

T24-1

5141501EN7-112

(1) Med. Base LED 2700K,
 8W, 800 Lumen lamp incl.

T24-2 EN*

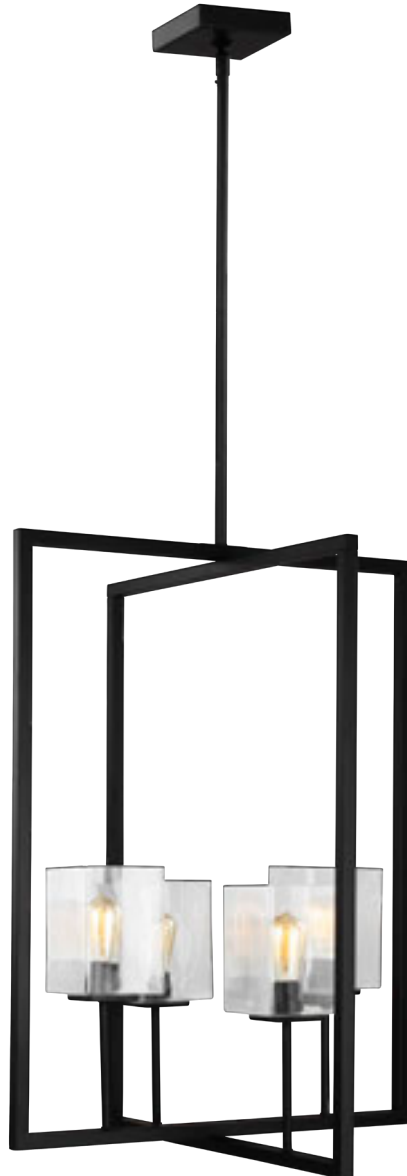

A

Midnight Black Finish (-112)
 Clear Glass



B

Midnight Black Finish (-112)
 Clear Glass



C

Midnight Black Finish (-112)
 Clear Glass

FINISH CODE

(-112) Midnight Black



PRODUCT SHOWN: LABETTE SMALL
THREE LIGHT LANTERN IN BLACK FINISH

A. LARGE FOUR LIGHT LANTERN

L: 14" W: 14" H: 27.25"
 10' Wire pre-laced through 6' Chain

DAMP

5340604-12

(4) Candelabra Base 60W max.

T24-1

5340604EN-12

(4) Cand. Base LED 2700K,
 3.5W, 350 Lumen lamps incl.

T24-2 EN*

B. MEDIUM THREE LIGHT LANTERN

L: 12" W: 12" H: 23.5"
 10' Wire pre-laced through 6' Chain

DAMP

5240603-12

(3) Candelabra Base 60W max.

T24-1

5240603EN-12

(3) Cand. Base LED 2700K,
 3.5W, 350 Lumen lamps incl.

T24-2 EN*

C. SMALL THREE LIGHT LANTERN

L: 10" W: 10" H: 19.75"
 10' Wire pre-laced through 6' Chain

DAMP

5140603-12

(3) Candelabra Base 60W max.

T24-1

5140603EN-12

(3) Cand. Base LED 2700K,
 3.5W, 350 Lumen lamps incl.

T24-2 EN*



A

Black Finish (-12)



B

Black Finish (-12)



C

Black Finish (-12)

FINISH CODE

(-12) Black

A. LARGE EIGHT LIGHT LANTERN

D: 18" H: 30"
10' of Wire pre-laced through 5' of Chain

DAMP

5134908(-05 -962 -710)

(8) Candelabra Torpedo 60W max.

T24-1

5134908EN(-05 -962 -710)

(8) Cand. Base LED 2700K,
3.5W, 350 Lumen lamps incl.

T24-2 EN*

B. MEDIUM SIX LIGHT LANTERN

D: 15" H: 23.375"
10' of Wire pre-laced through 5' of Chain

DAMP

5134906(-05 -962 -710)

(6) Candelabra Base 60W max.

T24-1

5134906EN(-05 -962 -710)

(6) Cand. Base LED 2700K,
3.5W, 350 Lumen lamps incl.

T24-2 EN*

C. SMALL THREE LIGHT LANTERN

D: 12.875" H: 18.75"
8' of Wire pre-laced through 3.5' of Chain

DAMP

5134903(-05 -962 -710)

(3) Candelabra Base 60W max.

T24-1

5134903EN(-05 -962 -710)

(3) Cand. Base LED 2700K,
3.5W, 350 Lumen lamps incl.

T24-2 EN*



A

Chrome Finish (-05)



B

Brushed Nickel Finish (-962)



C

Bronze Finish (-710)

FINISH CODES

(-05) Chrome
(-962) Brushed Nickel
(-710) Bronze

A. MEDIUM THREE LIGHT LANTERN

D: 15.75" H: 23.5"
 Supplied with 10' of Wire,
 (3) 12" Stems, (1) 6" Stem
 Sloped Ceiling Mounting Hardware incl.

DAMP

5126003(-962 -710)

(3) Medium ST19 75W max.

T24-1

5126003EN(-962 -710)

(3) LED E26 Medium A19
 8W Bulbs lamps incl.

T24-2 EN*



A

Brushed Nickel Finish (-962)
 Clear Seeded Glass



Bronze Finish (-710)
 Clear Seeded Glass

FINISH CODES

(-962) Brushed Nickel
 (-710) Bronze



PRODUCT SHOWN: THURLO LARGE HANGING SHADE
IN SATIN BRASS FINISH WITH NATURAL ABACA ROPE

HANGING SHADE

A. LARGE HANGING SHADE

DREW & JONATHAN
D: 32" H: 24.38"
10' of Wire, 6' of Chain
DAMP

DJP1074SB
(4) Medium A19 75W max.

B. MEDIUM HANGING SHADE

DREW & JONATHAN
D: 24.25" H: 15"
10' of Wire, 6' of Chain
DAMP

DJP1063SB
(3) Medium A19 75W max.

C. SMALL HANGING SHADE

DREW & JONATHAN
D: 14.25" H: 9.5"
10' of Wire, 6' of Chain
DAMP

DJP1052SB
(2) Medium A19 75W max.



A
Satin Brass Finish (SB)
Natural Abaca Rope Shade



B
Satin Brass Finish (SB)
Natural Abaca Rope Shade



C
Satin Brass Finish (SB)
Natural Abaca Rope Shade

FINISH CODE

(SB) Satin Brass

A. LARGE HANGING SHADE

DREW & JONATHAN
D: 18" H: 22.63"
10' of Wire, (3) 12" Stems, (1) 6" Stem
DAMP

DJP1002SB

(1) Medium A19 60W max.

B. MEDIUM HANGING SHADE

DREW & JONATHAN
D: 10" H: 16"
10' of Wire, (3) 12" Stems, (1) 6" Stem
DAMP

DJP1011SB

(2) Medium A19 60W max.



A

Satin Brass Finish (SB)
Natural Rattan
White Linen Fabric Shade



B

Satin Brass Finish (SB)
Natural Rattan
White Linen Fabric Shade

FINISH CODE

(SB) Satin Brass

**A. LARGE THREE LIGHT
HANGING SHADE**

D: 19.25" H: 13.5"
10' Wire, (3) 12" Stems, (1) 6" Stem
Sloped Ceiling Mounting
Hardware incl.

6628003(-962 -710)
(3) Medium Base 75W max.

T24-1

6628003EN3(-962 -710)
(3) Med. Base LED 3000K,
9W, 800 Lumen lamps incl.

T24-2 EN*



A

Brushed Nickel Finish (-962)
Off-White Faux Silk Fabric
Satin Etched Glass Diffuser



Bronze Finish (-710)
Off-White Faux Silk Fabric
Satin Etched Glass Diffuser

FINISH CODES

(-962) Brushed Nickel
(-710) Bronze

**B. MEDIUM TWO LIGHT SEMI-FLUSH
CONVERTIBLE HANGING SHADE**

D: 16.25" H: 12" Semi-Flush H: 10.75"
6' Wire pre-laced through 3' of Chain



7728002(-962 -710)

(2) Medium Base 75W max.



7728002EN3(-962 -710)

(2) Med. Base LED 3000K,
9W, 800 Lumen lamps incl.



B

Semi-flush in Brushed Nickel Finish (-962)
Off-White Faux Silk Fabric
Satin Etched Glass Diffuser



Bronze Finish (-710)
Off-White Faux Silk Fabric
Satin Etched Glass Diffuser

FINISH CODES

- (-962) Brushed Nickel
- (-710) Bronze



PRODUCT SHOWN: BELCARRA MEDIUM PENDANT
IN SATIN BRASS FINISH

PENDANTS

A. MEDIUM PENDANT

DREW & JONATHAN

D: 15" H: 10.25"

10' of Wire, (3) 12" Stems,

(1) 6" Stem

DAMP

DJP1091(BS SB MBK)

(1) Medium A19 75W max.



A

Brushed Steel Finish (BS)
Etched White Glass

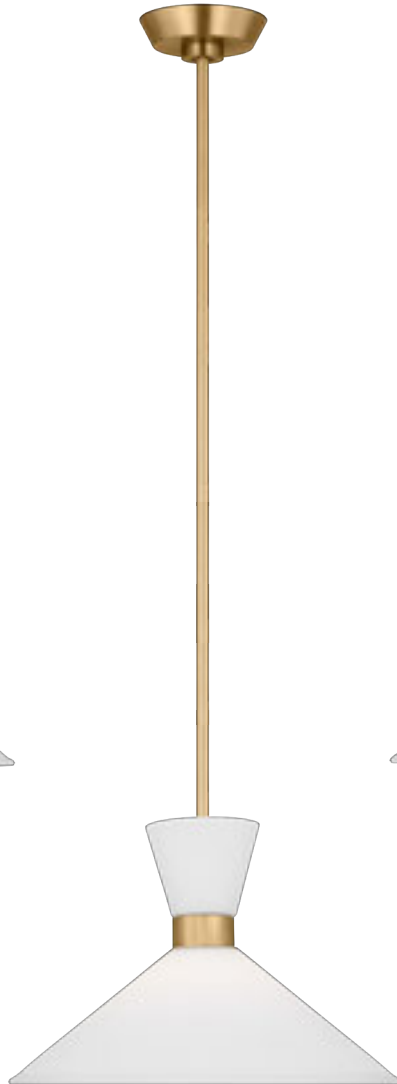

Satin Brass Finish (SB)
Etched White Glass



Midnight Black Finish (MBK)
Etched White Glass

FINISH CODES

(BS) Brushed Steel

(SB) Satin Brass

(MBK) Midnight Black

B. SMALL PENDANT

DREW & JONATHAN
 D: 8" H: 16.38"
 10' of Wire, (3) 12" Stems,
 (1) 6" Stem
DAMP

DJP1101(BS SB MBK)
 (1) Medium A19 75W max.



B

Brushed Steel Finish (BS)
 Etched White Glass

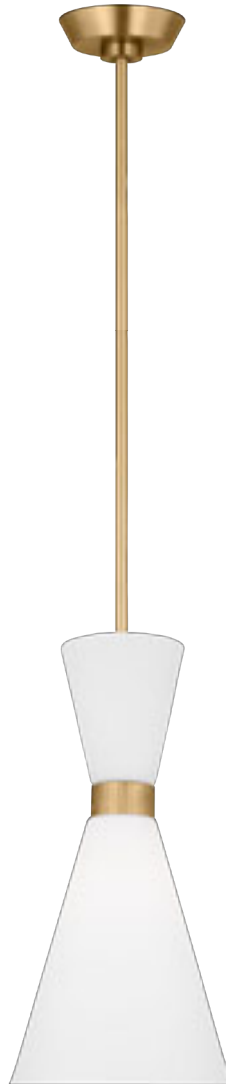

Satin Brass Finish (SB)
 Etched White Glass



Midnight Black Finish (MBK)
 Etched White Glass

FINISH CODES

(BS) Brushed Steel
 (SB) Satin Brass
 (MBK) Midnight Black

A. LARGE PENDANT

DREW & JONATHAN

D: 14" H: 13"

10' of Wire

DAMP

DJP1041(MWT NVY MBK)

(1) Medium A19 75W max.

B. MEDIUM PENDANT

DREW & JONATHAN

D: 12" H: 11"

10' of Wire

DAMP

DJP1031(MWT NVY MBK)

(1) Medium A19 75W max.

C. SMALL PENDANT

DREW & JONATHAN

D: 9.88" H: 9"

10' of Wire

DAMP

DJP1021(MWT NVY MBK)

(1) Medium A19 75W max.



A
Midnight Black Finish (MBK)
Opal Glass

B
Matte White Finish (MWT)
Opal Glass

C
Navy Finish (NVY)
Opal Glass

FINISH CODES

(MWT) Matte White

(NVY) Navy

(MBK) Midnight Black

A. MEDIUM PENDANT

DREW & JONATHAN

D: 12" H: 6.88"

10' of Wire

DAMP

DJP1111(SBMWT SBMBK)

(1) Medium A19 75W max.



A

Satin Brass Finish
Matte White Shade (SBMWT)



Satin Brass Finish
Midnight Black Shade (SBMBK)

FINISH CODES

(SBMWT) Satin Brass / Matte White Shade

(SBMBK) Satin Brass / Midnight Black Shade

A. ONE LIGHT MINI PENDANT

D: 5.25" H: 11.75"

Supplied with 6' Wire

DAMP

6140401(-848 -962)

(1) Medium A19 75W max.

6140401EN(-848 -962)

(1) LED Medium A19 9W Bulb lamps incl.

T24-2 EN*



A

Satin Brass Finish (-848)
Opal Etched Glass

Brushed Nickel Finish (-962)
Opal Etched Glass

FINISH CODES

(-848) Satin Brass

(-962) Brushed Nickel

A. ONE LIGHT PENDANT

D: 7.125" H: 12.75"
 Supplied with 10' of Wire,
 (3) 12" Stems, (1) 6" Stem
 Sloped Ceiling Mounting Hardware incl.

6536901(-710 -962)

(1) Medium ST19 60W max.

DAMP

6536901EN7(-710 -962)

(1) LED Medium A19 8W Bulb lamps incl.

T24-2 EN*



A

Bronze Finish (-710)
 Clear Seeded Glass



Brushed Nickel Finish (-962)
 Clear Seeded Glass

FINISH CODES

- (-710) Bronze
- (-962) Brushed Nickel

A. PENDANT

D: 9" H: 13.75"
15' Wire

P1395DFW/DWZ

(1) Medium A19 60W max.



A

Driftwood / Dark Weathered Zinc (DFW/DWZ)
Clear Glass



B

Driftwood / Dark Weathered Zinc (DFW/DWZ)
Clear Glass

FINISH CODE

(DFW/DWZ) Driftwood / Dark Weathered Zinc

A. PENDANT

D: 11.5" H: 14.75"
 15' Wire, (3) 12" Stems, (1) 6" Stem

DAMP

P1459 (CH DWI)

(1) Medium A19 60W max.

B. MINI PENDANT

D: 5.75" H: 9.5"
 15' Wire

DAMP

P1449 (CH DWI)

(1) Medium A19 75W max.



A

Chrome Finish (CH)
 Clear Seeded Glass



B

Dark Weathered Iron Finish (DWI)
 Clear Seeded Glass

FINISH CODES

(CH) Chrome
 (DWI) Dark Weathered Iron

**A. MEDIUM ONE
LIGHT PENDANT**

D: 9.25" H: 16.25"

Supplied with 15' of Wire,

(3) 12" Stems, (1) 6" Stem

Sloped Ceiling Mounting Hardware incl.

DAMP

P1484(CH SN ORB)

(1) Medium Base 60W max.

T24-1



A
Chrome Finish (CH)
Clear Glass



Satin Nickel Finish (SN)
Clear Glass



Oil Rubbed Bronze Finish (ORB)
Clear Glass

FINISH CODES

(CH) Chrome

(SN) Satin Nickel

(ORB) Oil Rubbed Bronze

A. MINI PENDANT

D: 5.5" H: 9.25"
15' Wire, (3) 12" Stems, (1) 6" Stem

DAMP

P1334SN/CH

(1) Medium A19 75W max.



A

Satin Nickel / Chrome Finish (SN/CH)
White Opal Etched Glass

FINISH CODE

(SN/CH) Satin Nickel / Chrome

A. BELL PENDANT

D: 5.75" H: 10"
Supplied with 15' Wire,
(3) 12" Stems, (1) 6" Stem

P1261ORB

(1) Medium A19 75W max.

B. ROUND GLASS PENDANT

D: 8" H: 8"
Supplied with 15' Wire,
(3) 12" Stems, (1) 6" Stem

P1234RI

(1) Medium A19 75W max.



A

Oil Rubbed Bronze Finish (ORB)
Clear Seeded Glass



B

Rustic Iron Finish (RI)
Clear Seeded Glass

FINISH CODES

(AF) Antique Forged Iron
(DAB) Dark Antique Brass
(ORB) Oil Rubbed Bronze
(RI) Rustic Iron

C. CLOSED CAGE PENDANT

D: 4.75" H: 14.5"
Supplied with 15' Wire,
(3) 12" Stems, (1) 6" Stem

P1240DAB

(1) Medium A19 75W max.

D. ROUND CAGE PENDANT

D: 10" H: 9.75"
Supplied with 15' Wire

DAMP

P1242AF

(1) Medium A19 75W max.



C

Dark Antique Brass Finish (DAB)



D

Antique Forged Iron Finish (AF)

FINISH CODES

(AF) Antique Forged Iron
(DAB) Dark Antique Brass
(ORB) Oil Rubbed Bronze
(RI) Rustic Iron



PRODUCT SHOWN: SOCORRO ONE LIGHT
MINI PENDANT IN STARDUST FINISH

A. ONE LIGHT MINI PENDANT

D: 10.5" H: 12.375"
 Supplied with 10' of Wire,
 (3) 12" Stems, (1) 6" Stem
 Sloped Ceiling Mounting Hardware incl.

DAMP

6124901-846

(1) Medium A19 60W max.

T24-1

6140401EN-846

(1) LED Medium A19 8W Bulb lamps incl.

T24-2 EN*



A

Stardust Finish (-846)

FINISH CODE

(-846) Stardust

A. MEDIUM PENDANT

D: 9.5" H: 14.125"

Supplied with 15' Wire, (3) 12" Stems, (1) 6" Stem

P1355(ORB SN)

(1) Medium A19 75W max.

B. MINI PENDANT

D: 7.5" H: 11.75"

Supplied with 15' Wire, (3) 12" Stems, (1) 6" Stem

P1357(ORB SN)

(1) Medium A19 75W max.

C. MINI PENDANT

D: 7.5" H: 11.75"

Supplied with 15' Wire,
(3) 12" Stems, (1) 6" Stem

P1354(ORB SN)

(1) Medium A19 75W max.



A

Satin Nickel Finish (SN)
Clear Seeded Glass



B

Oil Rubbed Bronze Finish (ORB)
Metal

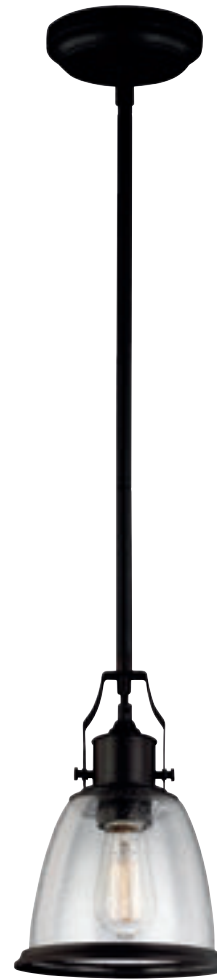

C

Oil Rubbed Bronze Finish (ORB)
Clear Seeded Glass

FINISH CODES

(ORB) Oil Rubbed Bronze

(SN) Satin Nickel

A. PENDANT

D: 13" H: 13.125"
Supplied with 15' Wire, 5' Chain

P1283DAB/MB

(12 Medium A19 75W max.)

B. MINI PENDANT

D: 8" H: 10.875"
Supplied with 15' Wire, 5" Chain

P1282DAB/MB

(1) Medium A19 75W max.



A

Dark Antique Brass / Matte Black (DAB/MB)
White Opal Etched Glass



B

Dark Antique Brass / Matte Black (DAB/MB)
White Opal Etched Glass

FINISH CODE

(DAB/MB) Dark Antique Brass / Matte Black



PRODUCT SHOWN: TOWNER FIVE LIGHT CLUSTER AND MULTI-PORT CANOPY IN SATIN BRASS FINISH

A. ONE LIGHT MINI-PENDANT

D: 7" H: 8.5"
 10' black field adjustable cord
 Compatible with Multi-Port Canopies

DAMP

6141301(-848 -962)

(1) Medium Base 60W max.

T24-1

6141301EN3(-848 -962)

(1) Med. Base LED 3000K,
 9W, 800 Lumen lamp incl.

T24-2 EN*



A

Satin Brass Finish (-848)
 Black Metal Shade



Brushed Nickel Finish (-962)
 Black Metal Shade

FINISH CODES

(-848) Satin Brass with Black Metal Shade
 (-962) Brushed Nickel with Black Metal Shade

A. MEDIUM ONE LIGHT PENDANT

D: 15" H: 14"
12' Black Field Adjustable Cord

DAMP

6517401(-962 -710 -846)

(1) Medium Base 75W max.

T24-1

6517401EN3(-962 -710 -846)

(1) Med. Base LED 3000K,
9W, 800 Lumen lamp incl.

T24-2 EN*



A

Brushed Nickel Finish (-962)

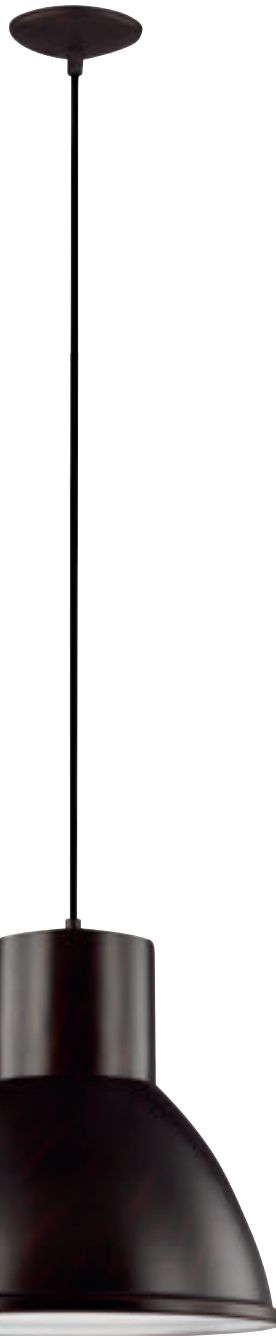

Bronze Finish (-710)



Stardust Finish (-846)

FINISH CODES

(-962) Brushed Nickel

(-710) Bronze

(-846) Stardust

A. ONE LIGHT INDOOR / OUTDOOR PENDANT

D: 13.25" H: 11.5"
 10' Wire, (3) 12" Stems,
 (1) 6" Stem
 Sloped Ceiling Mounting Hardware incl.

DAMP 

6247701(-04 -44 -12)
 (1) Medium Base 75W max.

T24-1

6247701EN3(-04 -44 -12)
 (1) Med. Base LED 3000K,
 9W, 800 Lumen lamp incl.

T24-2 EN*



A

Satin Aluminum Finish (-04)



Weathered Copper Finish (-44)



Black Finish (-12)

FINISH CODES

- (-04) Satin Aluminum
- (-44) Weathered Copper
- (-12) Black

A. LARGE THREE LIGHT PENDANT

D: 16.25" H: 10"
10' Wire, (3) 12" Stems, (1) 6" Stem
Sloped Ceiling Mounting
Hardware incl.

DAMP

65062(-962 -715)

(3) Medium Base 75W max.

T24-1

65062EN3(-962 -715)

(3) Med. Base LED 3000K,
9W, 800 Lumen lamps incl.

T24-2 EN*

B. MEDIUM TWO LIGHT PENDANT

D: 12.75" H: 8.5"
10' Wire, (3) 12" Stems, (1) 6" Stem
Sloped Ceiling Mounting
Hardware incl.

DAMP

65061(-962 -715)

(2) Medium Base 75W max.

T24-1

65061EN3(-962 -715)

(2) Med. Base LED 3000K,
9W, 800 Lumen lamps incl.

T24-2 EN*

C. SMALL ONE LIGHT PENDANT

D: 11" H: 7.25"
10' Wire, (3) 12" Stems, (1) 6" Stem
Sloped Ceiling Mounting
Hardware incl.

DAMP

65060(-962 -715)

(1) Medium Base 75W max.

T24-1

65060EN3(-962 -715)

(1) Med. Base LED 3000K,
9W, 800 Lumen lamp incl.

T24-2 EN*



A

Brushed Nickel Finish (-962)
Prismatic Glass & Diffuser

C

Brushed Nickel Finish (-962)
Prismatic Glass & Diffuser

B

Autumn Bronze Finish (-715)
Prismatic Glass & Diffuser

FINISH CODES

(-962) Brushed Nickel
(-715) Autumn Bronze

A. LARGE THREE LIGHT PENDANT

D: 16" H: 13.25"
 10' Wire, (3) 12" Stems,
 (1) 6" Stem
 Sloped Ceiling Mounting
 Hardware incl.

DAMP

65087(-848 -962 -715)
 (3) Medium Base 75W max.

T24-1

65087EN3(-848 -962 -715)
 (3) Med. Base LED 3000K,
 9W, 800 Lumen lamps incl.

T24-2 EN*

B. MEDIUM TWO LIGHT PENDANT

D: 13" H: 9.75"
 10' Wire, (3) 12" Stems,
 (1) 6" Stem
 Sloped Ceiling Mounting
 Hardware incl.

DAMP

65086(-848 -962 -715)
 (2) Medium Base 75W max.

T24-1

65086EN3(-848 -962 -715)
 (2) Med. Base LED 3000K,
 9W, 800 Lumen lamps incl.

T24-2 EN*

C. SMALL ONE LIGHT PENDANT

D: 9.5" H: 8.5"
 10' Wire, (3) 12" Stems,
 (1) 6" Stem
 Sloped Ceiling Mounting
 Hardware incl.

DAMP

65085(-848 -962 -715)
 (1) Medium Base 75W max.

T24-1

65085EN3(-848 -962 -715)
 (1) Med. Base LED 3000K,
 9W, 800 Lumen lamp incl.

T24-2 EN*



A

Satin Brass Finish (-848)
 Prismatic Glass Diffuser

C

Autumn Bronze Finish (-715)
 Prismatic Glass Diffuser

B

Brushed Nickel Finish (-962)
 Prismatic Glass Diffuser

FINISH CODES

- (-848) Satin Brass
- (-962) Brushed Nickel
- (-715) Autumn Bronze

**A. LARGE TWO
LIGHT PENDANT**

D: 17.25" H: 15.5"

10' Wire, (3) 12" Stems, (1) 6" Stem
Sloped Ceiling Mounting Hardware incl.
Head swivels.

DAMP +

6514402-962

(2) Medium Base 60W max.

T24-1

6514402EN3-962

(2) Med. Base LED 3000K,
9W, 800 Lumen lamps incl.

T24-2 EN*



A

Brushed Nickel Finish (-962)
Etched Glass Diffuser

FINISH CODE

(-962) Brushed Nickel

**B. MEDIUM ONE
LIGHT PENDANT**

D: 13.25" H: 12"
10' Wire, (3) 12" Stems, (1) 6" Stem
Sloped Ceiling Mounting
Hardware incl.
Head swivels.

DAMP +

6514401-962

(1) Medium Base 75W max.

T24-1

6514401EN3-962

(1) Med. Base LED 3000K,
9W, 800 Lumen lamp incl.

T24-2 EN*



B

Brushed Nickel Finish (-962)
Etched Glass Diffuser



Brushed Nickel Finish (-962)
Etched Glass Diffuser
Head swiveled

FINISH CODE

(-962) Brushed Nickel

A. MEDIUM PENDANT

D: 10" H: 10.5"
Supplied with 15' Wire

P1253 (BK BS DBZ)
(1) Medium A21 75W max.



A

Black Finish (BK)
With Polished Nickel (PN) Accent

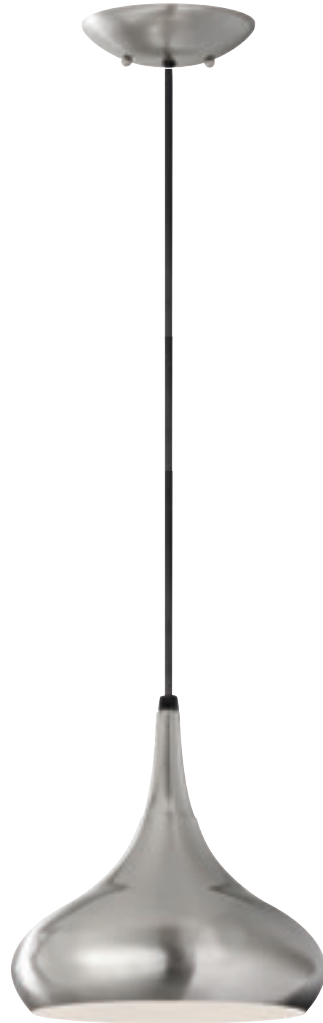

Brushed Steel Finish (BS)



Dark Bronze Finish (DBZ)
With Antique Copper (AC) Accent

FINISH CODES

(BK) Black
(BS) Brushed Steel
(DBZ) Dark Bronze
(PN) Polished Nickel

**A. SEVEN LIGHT
MULTI-PORT CANOPY**

D: 6.5" H: 2.625"
7 swag hooks incl.

MPC07ORBORB

Compatible with:
Belle
Division Street
Loras Mini
Matrimonio Mini
Towner
Urban Renewal

**B. THREE LIGHT
MULTI-PORT CANOPY**

D: 5" H: 1.25"
3 swag hooks incl.

MPC03ORB(ORB PN SN)

Compatible with:
Belle
Division Street
Loras Mini
Matrimonio Mini
Towner
Urban Renewal



A

Oil Rubbed Bronze Finish (ORB)



Polished Nickel Finish (PN)



Satin Nickel Finish (SN)



B

Oil Rubbed Bronze Finish (ORB)



Polished Nickel Finish (SN)



Satin Nickel Finish (SN)



Swag Hooks Included

FINISH CODES

(ORB) Oil Rubbed Bronze
(PN) Polished Nickel
(SN) Satin Nickel

A. FIVE LIGHT MULTI-PORT CANOPY

D: 12.25" H: 2"

DAMP

7449405(-15 -962 -848)

Compatible with:

Driscoll

Loras Mini

Matrimonio Mini

Towner



Shown with Towner Mini-Pendant in Satin Brass Finish (-962) and Black Shade



A

White Finish (-15)



Brushed Nickel Finish (-962)



Satin Brass Finish (-848)

FINISH CODES

- (-15) White
- (-962) Brushed Nickel
- (-848) Satin Brass

A. THREE LIGHT MULTI-PORT CANOPY

D: 9.5" H: 2"

DAMP

7449403(-15 -962 -848)

Compatible with:

- Belle
- Driscoll
- Hyde Small
- Loras Mini
- Matrimonio Mini
- Towner



Shown with Towner Mini-Pendant in Satin Brass Finish (-848) with Black Shade



A

White Finish (-15)



Brushed Nickel Finish (-962)



Satin Brass Finish (-848)

FINISH CODES

- (-15) White
- (-962) Brushed Nickel
- (-848) Satin Brass

MULTI-PORT CANOPIES PENDANTS

A. LINEAR FIVE LIGHT CLUSTER CANOPY

L: 48" W: 6" H: 1"

DAMP

7449605(-05 -962 -848 -112)

Compatible with:

Driscoll

Loras Mini

Matrimonio Mini

Towner



Shown with Matrimonio Mini Pendant in Satin Brass Finish (-848)



A

Chrome Finish (-05)



Brushed Nickel Finish (-962)



Satin Brass Finish (-848)



Midnight Black Finish (-112)

FINISH CODES

(-05) Chrome

(-962) Brushed Nickel

(-848) Satin Brass

(-112) Midnight Black

A. LINEAR THREE LIGHT CLUSTER CANOPY

L: 36" W: 6" H: 1"

DAMP

7449603(-05 -962 -848 -112)

Compatible with:

- Belle
- Driscoll
- Hyde Small
- Loras Mini
- Matrimonio Mini
- Towner



Shown with Loras Mini-Pendant in Midnight Black Finish (-112)



A

Chrome Finish (-05)



Brushed Nickel Finish (-962)



Satin Brass Finish (-848)



Midnight Black Finish (-112)

FINISH CODES

- (-05) Chrome
- (-962) Brushed Nickel
- (-848) Satin Brass
- (-112) Midnight Black



PRODUCT SHOWN: CORTES MEDIUM CEILING
FLUSH MOUNT IN SATIN BRASS FINISH

FLUSH AND
SEMI-FLUSH MOUNT

A. MEDIUM CEILING FLUSH MOUNT

DREW & JONATHAN

W: 13.5" H: 6.25"

DAMP T24-3

DJF1002SB

(2) Medium A19 40W max.



A

Satin Brass Finish (SB)
Rattan Detail with White Linen Shade
Etched White Glass Diffuser

FINISH CODE

(SB) Satin Brass

**A. MEDIUM CEILING
FLUSH MOUNT**

D: 12" H: 3.75"

DAMP

7569093S(-112 -848 -962)

(1) LED Integrated Array 15W
Bulb lamps incl.

T24-3 LED



A

Midnight Black Finish (-112)
White Etched Glass



Satin Brass Finish (-848)
White Etched Glass



Brushed Nickel Finish (-962)
White Etched Glass

FINISH CODES

- (-112) Midnight Black
- (-848) Satin Brass
- (-962) Brushed Nickel

SUNSET DRIVE

FLUSH AND SEMI-FLUSH MOUNT

A. LARGE THREE LIGHT FLUSH MOUNT

D: 16" H: 6.25"

DAMP

FM312(CH BS ORB)

(3) Medium Base 60W max.

T24-1

FM312EN3/(CH BS ORB)

(3) Med. Base LED 3000K,
9W, 800 Lumen lamps incl.

T24-2 EN*

B. MEDIUM TWO LIGHT FLUSH MOUNT

D: 13.5" H: 4.75"

DAMP

FM313(CH BS ORB)

(2) Medium Base 60W max.

T24-1

FM313EN3/(CH BS ORB)

(2) Med. Base LED 3000K,
9W, 800 Lumen lamps incl.

T24-2 EN*



A

Oil Rubbed Bronze Finish (ORB)
Opal Etched Glass



B

Brushed Steel Finish (BS)
Opal Etched Glass



Chrome Finish (CH)
Opal Etched Glass

FINISH CODES

(CH) Chrome

(BS) Brushed Steel

(ORB) Oil Rubbed Bronze

**A. GRANDE OVAL
LED FLUSH MOUNT**

L: 32.25" W: 18" H: 4"

DAMP

7950893S(-753 -71)

LED: 3000K, 42 Watts,
3295 Gross Lumens

T24-3 LED EN*



A

Painted Brushed Nickel Finish (-753)
White Acrylic Diffuser

**B. LARGE LED
FLUSH MOUNT**

D: 17.75" H: 4.25"

DAMP

7750893S(-753 -71)

LED: 3000K, 34 Watts,
2045 Gross Lumens

T24-3 LED EN*

**C. MEDIUM LED CEILING
FLUSH MOUNT**

D: 14.5" H: 4.125"

DAMP

7650893S(-753 -71)

LED: 3000K, 23 Watts,
1395 Gross Lumens

T24-3 LED EN*



B

Antique Bronze Finish (-71)
White Acrylic Diffuser



C

Painted Brushed Nickel Finish (-753)
White Acrylic Diffuser

FINISH CODES

(-753) Painted Brushed Nickel
(-71) Antique Bronze

A. LARGE CEILING FLUSH MOUNT

D: 16.75" H: 5.5"

DAMP

75436(-15 -05 -962 -848 -710 -112)

Bronze Finish / Amber Scavo Glass
(3) Medium Base 60W max.

T24-1

75436EN3(-15 -05 -962 -848 -710 -112)

Bronze Finish / Amber Scavo Glass
(3) Med. Base LED 3000K,
9W, 800 Lumen lamps incl.

T24-2 EN *



A

White Finish (-15)
White Satin Etched Glass



Chrome Finish (-05)
White Satin Etched Glass

B. MEDIUM CEILING FLUSH MOUNT

D: 14" H: 4.5"

DAMP

75435(-15 -05 -962 -848 -710 -112)

Bronze Finish / Amber Scavo Glass
(2) Medium Base 60W max.

T24-1

75435EN3(-15 -05 -962 -848 -710 -112)

Bronze Finish / Amber Scavo Glass
(2) Med. Base LED 3000K,
9W, 800 Lumen lamps incl.

T24-2 EN *



B

Bronze Finish (-710)
White Satin Etched Glass



Midnight Black Finish (-112)
White Satin Etched Glass

C. SMALL CEILING FLUSH MOUNT

D: 11.5" H: 4"

DAMP

75434(-15 -05 -962 -848 -710 -112)

Bronze Finish / Amber Scavo Glass
(1) Medium Base 60W max.

T24-1

75434EN3(-15 -05 -962 -848 -710 -112)

75444EN3-710 Bronze Finish / Amber Scavo Glass
(1) Med. Base LED 3000K,
9W, 800 Lumen lamps incl.

T24-2 EN *



C

Brushed Nickel Finish (-962)
White Satin Etched Glass



Satin Brass Finish (-848)
White Satin Etched Glass

FINISH CODES

- (-15) White
- (-05) Chrome
- (-962) Brushed Nickel
- (-848) Satin Brass
- (-710) Bronze
- (-112) Midnight Black

A. MEDIUM FLUSH MOUNT

D: 8" H: 6.88"

DAMP T24-3

DJF1011(MWT NVY MBK)

1 Medium A19 60W max.



A

Matte White Finish (MWT)
Milk Glass



Navy Finish (NVY)
Milk Glass



Midnight Black Finish (MBK)
Milk Glass

FINISH CODES

- (MWT) Matte White
- (NVY) Navy
- (MBK) Midnight Black

A. LARGE SEMI-FLUSH MOUNT

D: 16.375" H: 10.5"

DAMP

SF292AF/BS

(4) Candelabra Torpedo 60W max.



A

Antique Forged Iron / Brushed Steel (AF/BS)
Clear Glass

FINISH CODE

(AF/BS) Antique Forged Iron / Brushed Steel

MITTE

A. MEDIUM TWO LIGHT FLUSH MOUNT

L: 13" W: 13" H: 7.875"

DAMP

7541502-112

(2) Medium Base 60W max.

T24-1

7541502EN7-112

(2) Med. Base LED 2700K,
8W, 800 Lumen lamps incl.

T24-2 EN*



A

Midnight Black Finish (-112)
Clear Glass

FINISH CODE

(-112) Midnight Black

A. LARGE THREE LIGHT SEMI-FLUSH MOUNT

D: 15.5" H: 15.5"

DAMP

7724903-846

(3) Candelabra Torpedo 60W max.

T24-1

7724903EN-846

(3) LED Candelabra Torpedo 3.5W Bulbs lamps incl.

T24-2 EN*

B. LARGE TWO LIGHT FLUSH MOUNT

D: 13.5" H: 7.5"

DAMP

7524902-846

(2) Medium A19 60W max.

T24-1

7524902-846EN-846

(2) LED Medium A19 8W Bulbs lamps incl.

T24-2 EN*



A

Stardust Finish (846)



B

Stardust Finish (846)

FINISH CODE

(-846) Stardust

**A. SMALL ONE LIGHT
CEILING FLUSH MOUNT**

D: 6" H: 7.5"

DAMP

5367PC-15

(1) Medium Base 60W max.

T24-1

5367PCEN3-15

(1) Med. Base LED 3000K,
9W, 800 Lumen lamp incl.

T24-2 EN *



A

White Finish (-15)
White Glass, Pull Chain



B

White Finish (-15)
White Glass

**B. SMALL ONE LIGHT
CEILING FLUSH MOUNT**

D: 6" H: 7.5"

DAMP

5366-15

(1) Medium Base 60W max.

T24-1

5366EN3-15

(1) Med. Base LED 3000K,
9W, 800 Lumen lamp incl.

T24-2 EN *

FINISH CODE

(-15) White

WEBSTER

**A. SMALL TWO LIGHT
WALL / CEILING FLUSH MOUNT**

D: 9.5" H: 5.75" E: 5.75"

DAMP

5328(-15 -962 -710)

(2) Medium Base 60W max.

T24-1

5328EN3(-15 -962 -710)

(2) Med. Base LED 3000K,
9W, 800 Lumen lamps incl.

T24-2 EN *



A

Brushed Nickel Finish (-962)
Smooth White Glass



B

Bronze Finish (-710)
Smooth White Glass

**B. SMALL ONE LIGHT
WALL / CEILING FLUSH MOUNT**

D: 7.75" H: 5.25" E: 5.25"

DAMP

5326(-15 -962 -710)

(1) Medium Base 60W max.

T24-1

5326EN3(-15 -962 -710)

(1) Med. Base LED 3000K,
9W, 800 Lumen lamp incl.

T24-2 EN *

FINISH CODES

(-15) White
(-962) Brushed Nickel
(-710) Bronze

A. LARGE FLUSH MOUNT

D: 16.25" H: 4"

DAMP

7543503-962

(3) Medium Base 60W max.

T24-1

7543503EN3-962

(3) Med. Base LED 3000K, 9W, 800 Lumen lamps incl.

T24-2 EN*

7643593S-962

LED: 3000K, 28 Watts, 2000 Gross Lumens

T24-4 WOD LED EN*



A

Brushed Nickel Finish (-962)
White Satin Etched

B. MEDIUM FLUSH MOUNT

D: 12.25" H: 4"

DAMP

7543502-962

(2) Medium Base 60W max.

T24-1

7543502EN3-962

(2) Med. Base LED 3000K, 9W, 800 Lumen lamps incl.

T24-2 EN*

7443593S-962

LED: 3000K, 14 Watts, 1000 Gross Lumens

T24-4 WOD LED EN*



B

Brushed Nickel Finish (-962)
White Satin Etched

FINISH CODE

(-962) Brushed Nickel

**A. FOUR FOOT LED
CEILING / WALL MOUNT**

L: 46.5" W: 1.75" H: 1.875"
Height from center of the outlet box
horizontal: 0.875" vertical: 23.25"

DAMP ADA +

5920593S-15

LED: 3000K, 39 Watts
3000 Gross Lumens

T24-3 LED EN *

**B. TWO FOOT LED CEILING
FLUSH MOUNT**

L: 23" W: 1.75" H: 1.875"
Height from center of the outlet box
horizontal: 0.875" vertical: 11.5"

DAMP ADA +

5720593S-15

LED: 3000K, 19 Watts
1500 Gross Lumens

T24-3 LED EN *

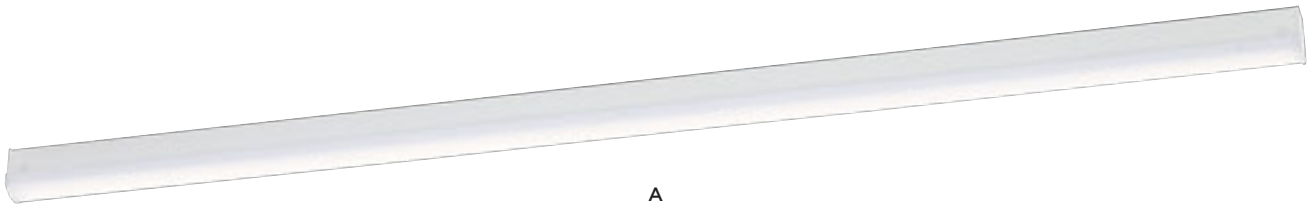

A

White Finish (-15)
White Acrylic Diffuser



B

White Finish (-15)
White Acrylic Diffuser

FINISH CODE

(-15) White

A. FOUR LIGHT CEILING FLUSH MOUNT

L: 51.5" W: 16.75" H: 5.75"

DAMP

59271LE-15

(4) Medium Bi-Pin T8 32W max.
120V NPF Electronic Ballast

T24-4 FL

B. TWO LIGHT CEILING FLUSH MOUNT

L: 51.5" W: 11.25" H: 5.75"

DAMP

59270LE-15

(2) Medium Bi-Pin T8 32W max.
120V NPF Electronic Ballast

T24-4 FL

C. LINEAR CEILING FLUSH MOUNT

L: 48" W: 6.75" H: 2.5"

DAMP

59132LE-15

(2) Medium Bi-Pin T8 32W max.
120V NPF Electronic Ballast

T24-4 FL

D. LINEAR CEILING FLUSH MOUNT

L: 24" W: 6.75" H: 2.5"

DAMP

59136LE-15

(2) Medium Bi-Pin T8 17W max.
120V NPF Electronic Ballast

T24-4 FL



A

White Finish (-15)
White Acrylic Diffuser



B

White Finish (-15)
White Acrylic Diffuser



C

White Finish (-15)
Clear Textured Acrylic Diffuser



D

White Finish (-15)
Clear Textured Acrylic Diffuser

FINISH CODE

(-15) White

A. LED LINEAR CEILING FLUSH MOUNT

L: 48" W: 5" H: 2.625"

DAMP

591320S-15

LED: 3000K, 40 Watts
3200 Gross Lumens

T24-3 LED

591321S-15

LED: 3000K, 40 Watts
3200 Gross Lumens

Includes Junction Box within

T24-3 LED

B. LED LINEAR CEILING FLUSH MOUNT

L: 24" W: 5" H: 2.625"

DAMP

591360S-15

LED: 3000K, 27 Watts
2000 Gross Lumens

T24-3 LED

591361S-15

LED: 3000K, 27 Watts
2000 Gross Lumens

Includes Junction Box within

T24-3 LED



A

White Finish (-15)
Frosted Acrylic Diffuser



B

White Finish (-15)
Frosted Acrylic Diffuser

FINISH CODE

(-15) White

A. FOUR FOOT LED CEILING FLUSH MOUNT

L: 51" W: 10.25" H: 3.25"

DAMP

5927093S-15

LED: 3000K, 39 Watts, 3220 Gross Lumens

T24-3 LED EN*

B. TWO FOOT LED CEILING FLUSH MOUNT

L: 26" W: 10.25" H: 3.25"

DAMP

5727093S-15

LED: 3000K, 27 Watts, 2100 Gross Lumens

T24-3 LED EN*



A

White Finish (-15)
White Acrylic Diffuser



B

White Finish (-15)
White Acrylic Diffuser

FINISH CODE

(-15) White



PRODUCT SHOWN: BURKE MEDIUM
SCONCE IN SATIN BRASS FINISH

WALL SCONCES

A. MEDIUM SCONCE

DREW & JONATHAN

W: 9" H: 16.88" E: 9.63"

Height from center of outlet box up: 10"

DAMP

DJW1011(SB MBK)

(1) Candelabra Torpedo 60W max.



A

Satin Brass Finish (SB)
White Linen Fabric Shade



Midnight Black Finish (MBK)
White Linen Fabric Shade

FINISH CODES

(SB) Satin Brass

(MBK) Midnight Black

BURKE

A. MEDIUM SCONCE

DREW & JONATHAN

W: 9" H: 8" E: 11"

Height from center of outlet box up: 5.5"

DAMP

DJW1001(BS SB MBK)

(1) Candelabra Torpedo 60W max.



A

Brushed Steel Finish (BS)
White Linen Fabric Shade



Satin Brass Finish (SB)
White Linen Fabric Shade



Midnight Black Finish (MBK)
White Linen Fabric Shade

FINISH CODES

(BS) Brushed Steel

(SB) Satin Brass

(MBK) Midnight Black

A. MEDIUM DOUBLE SCONCE

DREW & JONATHAN
 W: 5" H: 12" E: 5.25"
 Height from center of outlet box
 horizontal: 2.5" vertical: 6"
 DAMP

DJW1022(BS SB MBK)
 (2) Candelabra Torpedo 60W max.



A
 Brushed Steel Finish (BS)
 White Linen Fabric Shade



Satin Brass Finish (SB)
 White Linen Fabric Shade



Midnight Black Finish (MBK)
 White Linen Fabric Shade

FINISH CODES

(BS) Brushed Steel
 (SB) Satin Brass
 (MBK) Midnight Black

EGMONT

A. MEDIUM SCONCE

DREW & JONATHAN
 W: 4.75" H: 11.75" E: 5.5"
 Height from center of outlet box
 up: 9.375"
 DAMP

DJW1051(BS SB MBK)
 (1) Candelabra Torpedo 60W max.



Satin Brass Finish (SB)
 White Linen Fabric Shade



A
 Brushed Steel Finish (BS)
 White Linen Fabric Shade



Midnight Black Finish (MBK)
 White Linen Fabric Shade

FINISH CODES

(BS) Brushed Steel
 (SB) Satin Brass
 (MBK) Midnight Black



PRODUCT SHOWN: LORAS SCONCE IN CHROME FINISH

A. SCONCE

W: 5.75" H: 17" E: 8.5"
Height from center of outlet
box up: 9"

DAMP

WB1850(CH DWI)

(1) Medium A19 75W max.



A

Chrome Finish (CH)
Clear Seeded Glass



Dark Weathered Iron Finish (DWI)
Clear Seeded Glass

FINISH CODES

(CH) Chrome
(DWI) Dark Weathered Iron

A. WALL SCONCE

W: 5" H: 14.75" E: 4"
Height from center of
outlet box up: 7"

DAMP ADA

WB1451(BS ORB)

(1) Medium T10 60W max.



A

Brushed Steel (BS)
White Opal Etched Glass



Oil Rubbed Bronze (ORB)
White Opal Etched Glass

FINISH CODES

(BS) Brushed Steel
(ORB) Oil Rubbed Bronze

ETHAN

A. WALL SCONCE

W: 5" H: 17" E: 4.5"
Height from center of
outlet box up: 9.5"

WB1560AF/BS

(1) Candelabra B Torpedo
60W max.

T24-1



A

Antique Forged Iron / Brushed Steel (AF/BS)
Clear Glass

FINISH CODE

(AF/BS) Antique Forged Iron / Brushed Steel

MARIELLE

A. DOUBLE SCONCE

W: 10.5" H: 16.5" E: 3.75"
Height from center of
outlet box up: 10.625"

DAMP ADA

WB1920ADB

(2) Candelabra Torpedo
60W max.



A

Antique Gild (ADB)

FINISH CODE

(ADB) Antique Gild

A. LARGE SCONCE

W: 10.5" H: 18" E: 6"
 Height from center of outlet
 box up: 9"

DAMP

WB1846ANBZ

(1) Medium A19 75W max.



A

Antique Bronze (ANBZ)
 Clear Glass

FINISH CODE

(ANBZ) Antique Bronze

ANSLEY

A. ONE LIGHT SCONCE

W: 4.75" H: 26.5" E: 6.125"
 Height from center of outlet box up: 14.5" down:
 12"

DAMP

WB1940AI

(1) Candelabra Torpedo 60W max.



A

Aged Iron (AI)
 White Linen

FINISH CODE

(AI) Aged Iron

TOWNER

A. ONE LIGHT WALL SCONCE

W: 7" H: 8.375" E: 8"
 Height from center of outlet box
 up: 4.75" down: 2.5"

DAMP +

4141301(-848 -962)

(1) Medium Base 60W max.

T24-1

4141301EN3(-848 -962)

(1) Med. Base LED 3000K,
 9W, 800 Lumen lamp incl.

T24-2 EN*



A

Brushed Nickel Finish (-962)
 Black Metal Shade



Satin Brass Finish (-848)
 Black Metal Shade

FINISH CODES

(-962) Brushed Nickel
 (-848) Satin Brass

STEPPED GLASS WALL SCONCES

A. ONE LIGHT SCONCE

W: 10.75" H: 5.25" E: 4.25"
Height from center of outlet box up: 2.5"

DAMP

4123-15

(1) Medium Base 75W max.

T24-1

4123EN3-15

(1) Med. Base LED 3000K,
9W, 800 Lumen lamp incl.

T24-2 EN *



A

White Finish (-15)
White Glass

FINISH CODE

(-15) White

NEVA

A. ONE LIGHT SCONCE

W: 11.5" H: 5.75" E: 4"
Height from center of outlet box up: 2.5"

DAMP ADA

4148-15

(1) Medium Base 75W max.

T24-1

4148EN3-15

(1) Med. Base LED 3000K,
9W, 800 Lumen lamp incl.

T24-2 EN *

4148935-15

LED: 3000K, 14 Watts,
1000 Gross Lumens

T24-4 WOD EN * LED



A

White Finish (-15)
White Glass

FINISH CODE

(-15) White

EDLA

A. ONE LIGHT SCONCE

W: 13.75" H: 6.75" E: 5.25"
Height from center of outlet box up: 4"

DAMP

4138-15

(1) Medium Base 75W max.

T24-1

4138EN3-15

(1) Med. Base LED 3000K,
9W, 800 Lumen lamp incl.

T24-2 EN *



A

White Finish (-15)
White Acrylic Diffuser

FINISH CODE

(-15) White

A. LED SCONCE

W: 9.5" H: 10.5" E: 4"
 Height from center of outlet box up: 5.25"

DAMP ADA

4933593S-962

LED: 3000K, 14 Watts,
 1000 Gross Lumens

T24-4 WOD EN* LED



A

Brushed Nickel Finish
 Satin White Acrylic Diffuser

FINISH CODE

(-962) Brushed Nickel Finish

NEARU

A. ONE LIGHT SCONCE

W: 8" H: 10.5" E: 4"
 Height from center of outlet box up: 5.75"

DAMP ADA

49119(-962 -710)

(1) Medium Base 60W max.

T24-1

49119EN3(-962 -710)

(1) Med. Base LED 3000K,
 9W, 800 Lumen lamp incl.

T24-2 EN*



A

Brushed Nickel Finish (-962)
 Opal Cased Etched Glass



Bronze Finish (-710)
 Opal Cased Etched Glass

FINISH CODES

(-962) Brushed Nickel
 (-710) Bronze

METROPOLIS

A. ONE LIGHT SCONCE

W: 8" H: 8.25" E: 4"
 Height from center of outlet box up: 3.25"

DAMP ADA

41036-999

(1) Medium Base 75W max.

T24-1

41036EN3-999

(1) Med. Base LED 3000K,
 9W, 800 Lumen lamp incl.

T24-2 EN*



A

With Brushed Nickel &
 Brushed Nickel Endcaps
 with Satin Etched Glass

FINISH CODE

(-999) Multiple Finishes



PRODUCT SHOWN: SAYWARD THREE LIGHT
WALL / BATH IN BRUSHED STEEL FINISH

VANITY AND MIRRORS

A. FOUR LIGHT WALL / BATH

DREW & JONATHAN

W: 32.38" H: 9.63" E: 6.38"
 Height from center of outlet box
 up: 7.125" down:2.5"

DAMP +

DJV1004(CH BS SB MBK)

(4) Medium A19 75W max.



A

Chrome Finish (CH)
 Clear Glass

B. THREE LIGHT WALL / BATH

DREW & JONATHAN

W: 24" H: 9.63" E: 6.38"
 Height from center of outlet box
 up: 7.125" down:2.5"

DAMP +

DJV1003(CH BS SB MBK)

(3) Medium A19 75W max.



B

Satin Brass Finish (SB)
 Clear Glass

C. TWO LIGHT WALL / BATH

DREW & JONATHAN

W: 14.13" H: 9.63" E: 6.38"
 Height from center of outlet box
 up: 7.125" down:2.5"

DAMP +

DJV1002(CH BS SB MBK)

(2) Medium A19 75W max.

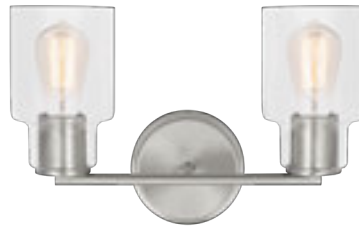

C

Brushed Steel Finish (BS)
 Clear Glass

D. SMALL WALL / BATH SCONCE

DREW & JONATHAN

W: 14.13" H: 9.63" E: 6.38"
 Height from center of outlet box
 up: 5.375" down:2.5"

DAMP +

DJV1001(CH BS SB MBK)

(1) Medium A19 75W max.



D

Midnight Black Finish (MBK)
 Clear Glass

FINISH CODES

- (CH) Chrome
- (BS) Brushed Steel
- (SB) Satin Brass
- (MBK) Midnight Black

A. FOUR LIGHT WALL / BATH

DREW & JONATHAN
 W: 33.38" H: 9" E: 7.5"
 Height from center of outlet box
 up: 6.5" down:2.5"



DJV1034(CH BS SB MBK)

(4) Medium A19 75W max.



A

Satin Brass Finish (SB)
 Clear Glass

B. THREE LIGHT WALL / BATH

DREW & JONATHAN
 W: 24" H: 9" E: 7.5"
 Height from center of outlet box
 up: 6.5" down:2.5"



DJV1033(CH BS SB MBK)

(3) Medium A19 75W max.



B

Brushed Steel Finish (BS)
 Clear Glass

C. TWO LIGHT WALL / BATH

DREW & JONATHAN
 W: 14.63" H: 9" E: 7.5"
 Height from center of outlet box
 up: 6.5" down:2.5"



DJV1032(CH BS SB MBK)

(2) Medium A19 75W max.



C

Midnight Black Finish (MBK)
 Clear Glass

D. SMALL WALL / BATH SCONCE

DREW & JONATHAN
 W: 5.25" H: 9" E: 7.5"
 Height from center of outlet box
 up: 5.5" down:3.5"



DJV1031(CH BS SB MBK)

(2) Medium A19 75W max.



D

Chrome Finish (SB)
 Clear Glass

FINISH CODES

- (CH) Chrome
- (BS) Brushed Steel
- (SB) Satin Brass
- (MBK) Midnight Black

A. FOUR LIGHT WALL / BATH

DREW & JONATHAN

W: 36" H: 8.88" E: 7.75"

Height from center of outlet box
up: 6.375" down:2.5"



DJV1024(CH BS SB MBK)

(4) Medium A19 60W max.



A

Chrome Finish (CH)
Milk Glass

B. THREE LIGHT WALL / BATH

DREW & JONATHAN

W: 26" H: 9" E: 7.75"

Height from center of outlet box
up: 6.375" down:2.5"



DJV1023(CH BS SB MBK)

(3) Medium A19 60W max.



B

Satin Brass Finish (SB)
Milk Glass

C. TWO LIGHT WALL / BATH

DREW & JONATHAN

W: 16" H: 9" E: 7.75"

Height from center of outlet box
up: 6.375" down:2.5"



DJV1022(CH BS SB MBK)

(2) Medium A19 60W max.



C

Brushed Steel Finish (BS)
Milk Glass

D. SMALL WALL / BATH SCONCE

DREW & JONATHAN

W: 6" H: 9" E: 7.75"

Height from center of outlet box
up: 6.375" down:2.5"



DJV1021(CH BS SB MBK)

(1) Medium A19 60W max.



D

Midnight Black Finish (MBK)
Milk Glass

FINISH CODES

(CH) Chrome

(BS) Brushed Steel

(SB) Satin Brass

(MBK) Midnight Black

A. FOUR LIGHT WALL / BATH

DREW & JONATHAN
 W: 36.75" H: 9.13" E: 9"
 Height from center of outlet box
 up: 4.125" down:2.5"
 DAMP +

DJV1014(BS SB MBK)
 (4) Candelabra B Torpedo 60W max.



A

Satin Brass Finish (SB)
 Etched White Glass

B. THREE LIGHT WALL / BATH

DREW & JONATHAN
 W: 27" H: 9.13" E: 9"
 Height from center of outlet box
 up: 7.125" down:2.5"
 DAMP +

DJV1013(BS SB MBK)
 (3) Candelabra B Torpedo 60W max.



B

Midnight Black Finish (MBK)
 Etched White Glass

C. TWO LIGHT WALL / BATH

DREW & JONATHAN
 W: 17.25" H: 9.13" E: 9"
 Height from center of outlet box
 up: 7.125" down:2.5"
 DAMP +

DJV1012(BS SB MBK)
 (2) Candelabra B Torpedo 60W max.

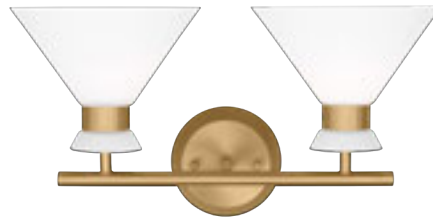

C

Satin Brass Finish (SB)
 Etched White Glass

D. SMALL WALL / BATH SCONCE

DREW & JONATHAN
 W: 7.5" H: 6.63" E: 9"
 Height from center of outlet box
 up: 7.125" down:2.5"
 DAMP +

DJV1011(BS SB MBK)
 (1) Candelabra B Torpedo 60W max.



D

Brushed Steel Finish (BS)
 Etched White Glass

FINISH CODES

- (BS) Brushed Steel
- (SB) Satin Brass
- (MBK) Midnight Black



PRODUCT SHOWN: WINDOM THREE LIGHT
WALL / BATH VANITY IN SATIN BRASS FINISH

A. FOUR LIGHT WALL / BATH

W: 24.375" H: 7.5" E: 6.625"
 Height from center of outlet box
 up: 5.1875" down: 2.3125"

DAMP +

4402804(-05 -962 -848 -710 -112)

(4) Medium Base 75W max.

T24-1

4402804EN3(-05 -962 -848 -710 -112)

(4) Med. Base LED 3000K,
 9W, 800 Lumen lamps incl.

T24-2 EN*



A

Satin Brass Finish (-848)
 Etched Opal Glass

B. THREE LIGHT WALL / BATH

W: 18" H: 7.5" E: 6.625"
 Height from center of outlet box
 up: 5.1875" down: 2.3125"

DAMP +

4402803(-05 -962 -848 -710 -112)

(3) Medium Base 75W max.

T24-1

4402803EN3(-05 -962 -848 -710 -112)

(3) Med. Base LED 3000K,
 9W, 800 Lumen lamps incl.

T24-2 EN*



B

Brushed Nickel Finish (-962)
 Etched Opal Glass

C. TWO LIGHT WALL / BATH

W: 12" H: 7.5" E: 6.625"
 Height from center of outlet box
 up: 5.1875" down: 2.3125"

DAMP +

4402802(-05 -962 -848 -710 -112)

(2) Medium Base 75W max.

T24-1

4402802EN3(-05 -962 -848 -710 -112)

(2) Med. Base LED 3000K,
 9W, 800 Lumen lamps incl.

T24-2 EN*



C

Chrome Finish (-05)
 Etched Opal Glass

D. ONE LIGHT WALL / BATH SCONCE

W: 4.5" H: 11.375" E: 6.625"
 Height from center of outlet box
 up: 7.375" down: 4"

DAMP +

4102801(-05 -962 -848 -710 -112)

(1) Medium Base 75W max.

T24-1

4102801EN3(-05 -962 -848 -710 -112)

(1) Med. Base LED 3000K,
 9W, 800 Lumen lamp incl.

T24-2 EN*



D

Bronze Finish (-710)
 Etched Opal Glass

Midnight Black Finish (-112)
 Etched Opal Glass

FINISH CODES

- (-05) Chrome
- (-962) Brushed Nickel
- (-848) Satin Brass
- (-710) Bronze
- (-112) Midnight Black



PRODUCT SHOWN: TOWNER THREE LIGHT
VANITY IN SATIN BRASS FINISH

A. FOUR LIGHT WALL / BATH

W: 35.375" H:7.25" E: 7.5"
 Height from center of outlet box
 up: 4.75" down: 2.5"

DAMP +

4441304(-848 -962)

(4) Medium Base 60W max.

T24-1

4441304EN3(-848 -962)

(4) Med. Base LED 3000K,
 9W, 800 Lumen lamp incl.

T24-2 EN*



A

Satin Brass Finish (-848)
 Black Metal Shades

B. THREE LIGHT WALL / BATH

W: 25.625" H: 7.25" E: 7.5"
 Height from center of outlet box
 up: 4.75" down: 2.5"

DAMP +

4441303(-848 -962)

(3) Medium Base 60W max.

T24-1

4441303EN3(-848 -962)

(3) Med. Base LED 3000K,
 9W, 800 Lumen lamp incl.

T24-2 EN*



B

Brushed Nickel Finish (-962)
 Black Metal Shades

C. TWO LIGHT WALL / BATH

W: 15.75" H: 7.25" E: 7.5"
 Height from center of outlet box
 up: 4.75" down: 2.5"

DAMP +

4441302(-848 -962)

(2) Medium Base 60W max.

T24-1

4441302EN3(-848 -962)

(2) Med. Base LED 3000K,
 9W, 800 Lumen lamp incl.

T24-2 EN*



C

Satin Brass Finish (-848)
 Black Metal Shades

D. ONE LIGHT WALL SCNCE

W: 7" H: 8.375" E: 8"
 Height from center of outlet box
 up: 4.75" down: 2.5"

DAMP +

4141301(-848 -962)

(1) Medium Base 60W max.

T24-1

4141301EN3(-848 -962)

(1) Med. Base LED 3000K,
 9W, 800 Lumen lamp incl.

T24-2 EN*



D

Brushed Nickel Finish (-962)
 Black Metal Shade

FINISH CODES

(-848) Satin Brass
 (-962) Brushed Nickel

A. FOUR LIGHT WALL / BATH

W: 33" H: 9.125" E: 7.25"
 Height from center of outlet box
 up: 5.625" down: 3.5"

DAMP +

4441504-112

(4) Medium Base 75W max.

T24-1

4441504EN7-112

(4) Med. Base LED 2700K,
 8W, 800 Lumen lamps incl.

T24-2 EN *



A

Midnight Black Finish (-112)
 Clear Glass

B. THREE LIGHT WALL / BATH

W: 24" H: 9.125" E: 7.25"
 Height from center of outlet box
 up: 5.625" down: 3.5"

DAMP +

4441503-112

(3) Medium Base 75W max.

T24-1

4441503EN7-112

(3) Med. Base LED 2700K,
 8W, 800 Lumen lamps incl.

T24-2 EN *



B

Midnight Black Finish (-112)
 Clear Glass

C. TWO LIGHT WALL / BATH

W: 15" H: 9.125" E: 7.25"
 Height from center of outlet box
 up: 5.625" down: 3.5"

DAMP +

4441502-112

(2) Medium Base 75W max.

T24-1

4441502EN7-112

(2) Med. Base LED 2700K,
 8W, 800 Lumen lamps incl.

T24-2 EN *



C

Midnight Black Finish (-112)
 Clear Glass

D. ONE LIGHT WALL / BATH SCNCE

W: 6.5" H: 8.375" E: 6.5"
 Height from center of outlet box
 up: 5.625" down: 2.75"

DAMP +

4141501-112

(1) Medium Base 75W max.

T24-1

4141501EN7-112

(1) Med. Base LED 2700K,
 8W, 800 Lumen lamp incl.

T24-2 EN *



D

Midnight Black Finish (-112)
 Clear Glass

FINISH CODE

(-112) Midnight Black

A. TWO LIGHT SCONCE

W: 20.25" H: 5.5" E: 5.875"
 Height from center of outlet box up
 to horizontal: 2.75" vertical: 10.25"

DAMP +

WB1704(DAB PN)

(2) Medium A19 75W max.

T24-1



A

Polished Nickel Finish (PN)

B. ONE LIGHT SCONCE

W: 5.5" H: 12.25" E: 7.75"
 Height from center of outlet box
 up: 6" down: 6.25"

DAMP +

WB1703(DAB PN)

(1) Medium A19 75W max.

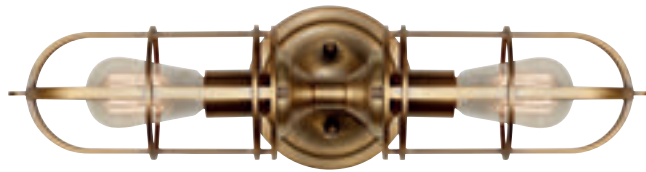

Dark Antique Brass Finish (DAB)



B

Dark Antique Brass Finish (DAB)



Polished Nickel Finish (PN)

FINISH CODES

(DAB) Dark Antique Brass
 (PN) Polished Nickel



PRODUCT SHOWN: ADELAIDE ONE LIGHT
WALL / BATH SCONCE IN MIDNIGHT BLACK

A. FOUR LIGHT VANITY

W: 33.5" H: 9.5" E: 7"
 Height from center of outlet box
 up: 7.125" down: 2.375"

DAMP +

VS2474MBK

(4) Medium A19 75W max.
 T24-1



A

Midnight Black Finish (MBK)
 Clear Seeded Glass

B. THREE LIGHT VANITY

W: 24" H: 9.5" E: 7"
 Height from center of outlet box
 up: 7.125" down: 2.375"

DAMP +

VS2473MBK

(3) Medium A19 75W max.



B

Midnight Black Finish (MBK)
 Clear Seeded Glass

C. TWO LIGHT VANITY

W: 14.5" H: 9.5" E: 7"
 Height from center of outlet box
 up: 7.125" down: 2.375"

DAMP +

VS2472MBK

(2) Medium A19 75W max.



C

Midnight Black Finish (MBK)
 Clear Seeded Glass

D. ONE LIGHT SCNCE

W: 5.375" H: 13.5" E: 7"
 Height from center of outlet box
 up: 9.5" down: 4"

DAMP +

VS2471MBK

(1) Medium A19 75W max.



D

Midnight Black Finish (MBK)
 Clear Seeded Glass

FINISH CODE

(MBK) Midnight Black

A. FOUR LIGHT WALL / BATH

W: 27.5" H: 8.5" E: 5.5"
 Height from center of outlet box
 up: 6.25" down: 2.25"

DAMP +

41163(-05 -962 -710 -112)

(4) Medium Base 75W max.

T24-1

41163EN3(-05 -962 -710 -112)

(4) Med. Base LED 3000K,
 9W, 800 Lumen lamps incl.

T24-2 EN *



A

Chrome Finish (-05)
 Cased Opal Etched Glass

B. THREE LIGHT WALL / BATH

W: 20" H: 8.5" E: 5.5"
 Height from center of outlet box
 up: 6.25" down: 2.25"

DAMP +

41162(-05 -962 -710 -112)

(3) Medium Base 75W max.

T24-1

41162EN3(-05 -962 -710 -112)

(3) Med. Base LED 3000K,
 9W, 800 Lumen lamps incl.

T24-2 EN *



B

Brushed Nickel Finish (-962)
 Cased Opal Etched Glass

C. TWO LIGHT WALL / BATH

W: 12.5" H: 8.5" E: 5.5"
 Height from center of outlet box
 up: 6.25" down: 2.25"

DAMP +

41161(-05 -962 -710 -112)

(2) Medium Base 75W max.

T24-1

41161EN3(-05 -962 -710 -112)

(2) Med. Base LED 3000K,
 9W, 800 Lumen lamps incl.

T24-2 EN *



C

Bronze Finish (-710)
 Cased Opal Etched Glass

D. ONE LIGHT WALL / BATH SCNCE

W: 4.75" H: 8.75" E: 5.5"
 Height from center of outlet box
 up: 4.75" down: 4"

DAMP +

41160(-05 -962 -710 -112)

(1) Medium Base 75W max.

T24-1

41160EN3(-05 -962 -710 -112)

(1) Med. Base LED 3000K,
 9W, 800 Lumen lamp incl.

T24-2 EN *



D

Midnight Black Finish (-112)
 Cased Opal Etched Glass

FINISH CODES

- (-05) Chrome
- (-962) Brushed Nickel
- (-710) Bronze
- (-112) Midnight Black

A. FOUR LIGHT WALL / BATH

W: 27.5" H: 8.5" E: 5.5"
 Height from center of outlet box
 up: 6.25" down: 2.25"

DAMP

41173(-05 -112 -710 -962)

(4) Medium Base 75W max.

T24-1

41173EN7(-05 -112 -710 -962)

(4) Med. Base LED 2700K,
 8W, 800 Lumen lamps incl.

T24-2 EN*



A

Bronze Finish (-710)
 Clear Seeded Glass

B. THREE LIGHT WALL / BATH

W: 20" H: 8.5" E: 5.5"
 Height from center of outlet box
 up: 6.25" down: 2.25"

DAMP

41172(-05 -112 -710 -962)

(3) Medium Base 75W max.

T24-1

41172EN7(-05 -112 -710 -962)

(3) Med. Base LED 2700K,
 8W, 800 Lumen lamps incl.

T24-2 EN*



B

Brushed Nickel Finish (-962)
 Clear Seeded Glass

C. TWO LIGHT WALL / BATH

W: 12.5" H: 8.5" E: 5.5"
 Height from center of outlet box
 up: 6.25" down: 2.25"

DAMP +

41171(-05 -112 -710 -962)

(2) Medium Base 75W max.

T24-1

41171EN7(-05 -112 -710 -962)

(2) Med. Base LED 2700K,
 8W, 800 Lumen lamps incl.

T24-2 EN*



C

Chrome Finish (-05)
 Clear Seeded Glass

D. ONE LIGHT WALL / BATH SCONCE

W: 4.75" H: 8.75" E: 5.5"
 Height from center of outlet box
 up: 4.75" down: 4"

DAMP +

41170(-05 -112 -710 -962)

(1) Medium Base 75W max.

T24-1

41170EN7(-05 -112 -710 -962)

(1) Med. Base LED 2700K,
 8W, 800 Lumen lamp incl.

T24-2 EN*



D

Midnight Black Finish (-112)
 Clear Seeded Glass

FINISH CODES

- (-05) Chrome
- (-962) Brushed Nickel
- (-710) Bronze
- (-112) Midnight Black

A. FOUR LIGHT WALL / BATH

W: 31.25" H: 8.5" E: 6.25"
 Height from center of outlet box
 up: 6.25" down: 2.25"

DAMP +

4437304(-962 -710)

(4) Medium Base 75W max.

T24-1

4437304EN3(-962 -710)

(4) Med. Base LED 3000K,
 9W, 800 Lumen lamps incl.

T24-2 EN *



A

Brushed Nickel Finish (-962)
 Satin Etched Inner Glass, Clear Outer Glass

B. THREE LIGHT WALL / BATH

W: 22.25" H: 8.5" E: 6.25"
 Height from center of outlet box
 up: 6.25" down: 2.25"

DAMP +

4437303(-962 -710)

(3) Medium Base 75W max.

T24-1

4437303EN3(-962 -710)

(3) Med. Base LED 3000K,
 9W, 800 Lumen lamps incl.

T24-2 EN *



B

Bronze Finish (-710)
 Satin Etched Inner Glass, Clear Outer Glass

C. TWO LIGHT WALL / BATH

W: 13.25" H: 8.5" E: 6.25"
 Height from center of outlet box
 up: 6.25" down: 2.25"

DAMP +

4437302(-962 -710)

(2) Medium Base 75W max.

T24-1

4437302EN3(-962 -710)

(2) Med. Base LED 3000K,
 9W, 800 Lumen lamps incl.

T24-2 EN *



C

Brushed Nickel Finish (-962)
 Satin Etched Inner Glass, Clear Outer Glass

D. ONE LIGHT WALL / BATH SCNCE

W: 4.5" H: 8" E: 6.25"
 Height from center of outlet box
 up: 5" down: 3"

DAMP +

4137301(-962 -710)

(1) Medium Base 75W max.

T24-1

4137301EN3(-962 -710)

(1) Med. Base LED 3000K,
 9W, 800 Lumen lamps incl.

T24-2 EN *



D

Bronze Finish (-710)
 Satin Etched Inner Glass, Clear Outer Glass

FINISH CODES

(-962) Brushed Nickel
 (-710) Bronze

A. FOUR LIGHT WALL / BATH

W: 31.875" H: 8.375" E: 7.25"
 Height from center of outlet box
 up: 5.75" down: 2.5"

DAMP +

4428804(-05 -962 -710)

(4) Medium Base 75W max.

T24-1

4428804EN3(-05 -962 -710)

(4) Med. Base LED 3000K,
 9W, 800 Lumen lamp incl.

T24-2 EN*



A

Midnight Black Finish (-112)
 Etched White Glass

B. THREE LIGHT WALL / BATH

W: 23.125" H: 8.375" E: 7.25"
 Height from center of outlet box
 up: 5.75" down: 2.5"

DAMP +

4428803(-05 -962 -710)

(3) Medium Base 75W max.

T24-1

4428803EN3(-05 -962 -710)

(3) Med. Base LED 3000K,
 9W, 800 Lumen lamp incl.

T24-2 EN*



B

Brushed Nickel Finish (-962)
 Etched, White Inside Glass

C. TWO LIGHT WALL / BATH

W: 14.25" H: 8.375" E: 7.25"
 Height from center of outlet box
 up: 5.75" down: 2.5"

DAMP +

4428802(-05 -962 -710)

(2) Medium Base 75W max.

T24-1

4428802EN3(-05 -962 -710)

(2) Med. Base LED 3000K,
 9W, 800 Lumen lamp incl.

T24-2 EN*



C

Bronze Finish (-710)
 Etched, White Inside Glass

D. ONE LIGHT WALL / BATH SCONCE

W: 5.5" H: 8.25" E: 7.25"
 Height from center of outlet box
 up: 4.375" down: 3.875"

DAMP +

4128801(-05 -962 -710)

(1) Medium Base 75W max.

T24-1

4128801EN3(-05 -962 -710)

(1) Med. Base LED 3000K,
 9W, 800 Lumen lamp incl.

T24-2 EN*



D

Chrome Finish (-05)
 Etched, White Inside Glass

FINISH CODES

- (-05) Chrome
- (-962) Brushed Nickel
- (-710) Bronze
- (-112) Midnight Black



PRODUCTS SHOWN: DRISCOLL ONE LIGHT
WALL / BATH SCONCE IN SATIN BRASS FINISH
AND KIT ROUND MIRROR IN BURNISHED BRASS

A. FOUR LIGHT WALL / BATH

W: 30.75" H: 12" E: 7"
Height from center of outlet box
up: 9.75" down: 3"

DAMP +

4440404(-05 -848 -962)

(4) Medium A19 75W max.

T24-1

4440404EN3(-05 -848 -962)

(4) LED Medium A19 9W Bulbs lamps incl.

T24-2 EN*



A

Satin Brass Finish (-848)
Opal Etched Glass

B. THREE LIGHT WALL / BATH

W: 24.5" H: 12" E: 7"
Height from center of outlet box
up: 8.75" down: 3.2"

DAMP +

4440403(-05 -848 -962)

(3) Medium A19 75W max.

T24-1

4440403EN3(-05 -848 -962)

(3) LED Medium A19 9W Bulbs lamps incl.

T24-2 EN*



B

Chrome Finish (-05)
Opal Etched Glass

C. TWO LIGHT WALL / BATH

W: 15.25" H: 12" E: 7"
Height from center of outlet box
up: 8.75" down: 3.2"

DAMP +

4440402(-05 -848 -962)

(2) Medium A19 75W max.

T24-1

4440402EN3(-05 -848 -962)

(2) LED Medium A19 9W Bulbs lamps incl.

T24-2 EN*



C

Satin Brass Finish (-848)
Opal Etched Glass

D. ONE LIGHT WALL / BATH SCONCE

W: 5.25" H: 12" E: 6.75"
Height from center of outlet box
up: 8.75" down: 3"

DAMP +

4140401(-05 -848 -962)

(1) Medium A19 75W max.

T24-1

4140401EN3(-05 -848 -962)

(1) LED Medium A19 9W Bulbs lamps incl.

T24-2 EN*



D

Brushed Nickel Finish (-962)
Opal Etched Glass

FINISH CODES

- (-05) Chrome
- (-848) Satin Brass
- (-962) Brushed Nickel

A. FIVE LIGHT WALL / BATH

W: 35.875" H: 8.5" E: 6.625"
Height from center of outlet box
up: 5.125" down: 3.375"

DAMP +

4420205(-05 -962 -710)

(5) Medium Base 75W max.

T24-1

4420205EN3(-05 -962 -710)

(5) Med. Base LED 3000K,
9W, 800 Lumen lamp incl.

T24-2 EN*

B. FOUR LIGHT WALL / BATH

W: 28.375" H: 8.5" E: 6.625"
Height from center of outlet box
up: 5.125" down: 3.375"

DAMP +

4420204(-05 -962 -710)

(4) Medium Base 75W max.

T24-1

4420204EN3(-05 -962 -710)

(4) Med. Base LED 3000K,
9W, 800 Lumen lamp incl.

T24-2 EN*



A

Chrome Finish (-05)
Etched, White Inside Glass



B

Brushed Nickel Finish (-962)
Etched, White Inside Glass

FINISH CODES

(-05) Chrome
(-962) Brushed Nickel
(-710) Bronze

C. THREE LIGHT WALL / BATH

W: 21" H: 8.5" E: 6.625"
 Height from center of outlet box
 up: 5.125" down: 3.375"

DAMP +

4420203(-05 -962 -710)

(3) Medium Base 75W max.

T24-1

4420203EN3(-05 -962 -710)

(3) Med. Base LED 3000K,
 9W, 800 Lumen lamp incl.

T24-2 EN*



C

Bronze Finish (-710)
 Etched, White Inside Glass

D. TWO LIGHT WALL / BATH

W: 13.5" H: 8.5" E: 6.625"
 Height from center of outlet box
 up: 5.125" down: 3.375"

DAMP +

4420202(-05 -962 -710)

(2) Medium Base 75W max.

T24-1

4420202EN3(-05 -962 -710)

(2) Med. Base LED 3000K,
 9W, 800 Lumen lamp incl.

T24-2 EN*



D

Chrome Finish (-05)
 Etched, White Inside Glass

E. ONE LIGHT WALL / BATH SCONCE

W: 4.75" H: 8.5" E: 6.625"
 Height from center of outlet box
 up: 3.375" down: 5.125"

DAMP +

4120201(-05 -962 -710)

(1) Medium Base 75W max.

T24-1

4120201EN3(-05 -962 -710)

(1) Med. Base LED 3000K,
 9W, 800 Lumen lamp incl.

T24-2 EN*



E

Brushed Nickel Finish (-962)
 Etched, White Inside Glass

FINISH CODES

- (-05) Chrome
- (-962) Brushed Nickel
- (-710) Bronze

A. FOUR LIGHT WALL / BATH

W: 24.75" H: 9" E: 6.75"
 Height from center of outlet box
 up: 6.75" down: 2.25"

DAMP +

4415204(-05 -962 -710)

(4) Medium Base 75W max.

T24-1

4415204EN3(-05 -962 -710)

(4) Med. Base LED 3000K,
 9W, 800 Lumen lamp incl.

T24-2 EN *



A

Chrome Finish (-05)
 Satin Etched Glass

B. THREE LIGHT WALL / BATH

W: 18" H: 9" E: 6.75"
 Height from center of outlet box
 up: 6.75" down: 2.25"

DAMP +

4415203(-05 -962 -710)

(3) Medium Base 75W max.

T24-1

4415203EN3(-05 -962 -710)

(3) Med. Base LED 3000K,
 9W, 800 Lumen lamp incl.

T24-2 EN *



B

Brushed Nickel Finish (-962)
 Satin Etched Glass

C. TWO LIGHT WALL / BATH

W: 12" H: 9" E: 6.75"
 Height from center of outlet box
 up: 6.75" down: 2.25"

DAMP +

4415202(-05 -962 -710)

(2) Medium Base 75W max.

T24-1

4415202EN3(-05 -962 -710)

(2) Med. Base LED 3000K,
 9W, 800 Lumen lamp incl.

T24-2 EN *



C

Bronze Finish (-710)
 Satin Etched Glass

D. ONE LIGHT WALL / BATH SCNCE

W: 4.75" H: 9.75" E: 6.75"
 Height from center of outlet box
 up: 5.75" down: 4"

DAMP +

4115201(-05 -962 -710)

(1) Medium Base 75W max.

T24-1

4115201EN3(-05 -962 -710)

(1) Med. Base LED 3000K,
 9W, 800 Lumen lamp incl.

T24-2 EN *



D

Chrome Finish (-05)
 Satin Etched Glass

FINISH CODES

- (-05) Chrome
- (-962) Brushed Nickel
- (-710) Bronze

A. FOUR LIGHT WALL / BATH

W: 28.75" H: 10.75" E: 6.75"
 Height from center of outlet box
 up: 8.5" down: 2.25"

DAMP +

4414504(-05 -962 -710 -112)

(4) Medium Base 60W max.

T24-1

4414504EN7(-05 -962 -710 -112)

(4) Med. Base LED 2700K,
 8W, 800 Lumen lamps incl.

T24-2 EN*



A

Chrome Finish (-05)
 Clear Seeded Glass

B. THREE LIGHT WALL / BATH

W: 21" H: 10.75" E: 6.75"
 Height from center of outlet box
 up: 8.5" down: 2.25"

DAMP +

4414503(-05 -962 -710 -112)

(3) Medium Base 60W max.

T24-1

4414503EN7(-05 -962 -710 -112)

(3) Med. Base LED 2700K,
 8W, 800 Lumen lamps incl.

T24-2 EN*



B

Brushed Nickel Finish (-962)
 Clear Seeded Glass

C. TWO LIGHT WALL / BATH

W: 15" H: 10.75" E: 6.75"
 Height from center of outlet box
 up: 8.5" down: 2.25"

DAMP +

4414502(-05 -962 -710 -112)

(2) Medium Base 60W max.

T24-1

4414502EN7(-05 -962 -710 -112)

(2) Med. Base LED 2700K,
 8W, 800 Lumen lamps incl.

T24-2 EN*



C

Bronze Finish (-710)
 Clear Seeded Glass

D. ONE LIGHT WALL / BATH SCONCE

W: 5.5" H: 9.75" E: 6.75"
 Height from center of outlet box
 up: 5.5" down: 4.25"

DAMP +

4414501(-05 -962 -710 -112)

(1) Medium Base 60W max.

T24-1

4414501EN7(-05 -962 -710 -112)

(1) Med. Base LED 2700K,
 8W, 800 Lumen lamp incl.

T24-2 EN*



D

Midnight Black Finish (-112)
 Clear Seeded Glass

FINISH CODES

- (-05) Chrome
- (-962) Brushed Nickel
- (-710) Bronze
- (-112) Midnight Black

A. FOUR LIGHT WALL / BATH

W: 34" H: 7.125" E: 7.375"
 Height from center of outlet box
 up: 2.5625" down: 4.5265"

DAMP +

4430704(-962 -710 -112)

(4) Medium Base 75W max.

T24-1

4430704EN3(-962 -710 -112)

(4) Med. Base LED 3000K,
 9W, 800 Lumen lamps incl.

T24-2 EN*



A

Brushed Nickel Finish (-962)
 Etched, White Inside Glass

B. THREE LIGHT WALL / BATH

W: 24" H: 7.125" E: 7.375"
 Height from center of outlet box
 up: 2.5625" down: 4.5265"

DAMP +

4430703(-962 -710 -112)

(3) Medium Base 75W max.

T24-1

4430703EN3(-962 -710 -112)

(3) Med. Base LED 3000K,
 9W, 800 Lumen lamps incl.

T24-2 EN*



B

Bronze Finish (-710)
 Etched, White Inside Glass

C. TWO LIGHT WALL / BATH

W: 13.75" H: 7.125" E: 7.375"
 Height from center of outlet box
 up: 2.5625" down: 4.5265"

DAMP +

4430702(-962 -710 -112)

(2) Medium Base 75W max.

T24-1

4430702EN3(-962 -710 -112)

(2) Med. Base LED 3000K,
 9W, 800 Lumen lamps incl.

T24-2 EN*



C

Midnight Black Finish (-112)
 Etched, White Inside Glass

D. ONE LIGHT WALL / BATH SCNCE

W: 5" H: 15" E: 6.25"
 Height from center of outlet box
 up: 6" down: 8"

DAMP +

4130701(-962 -710 -112)

(1) Medium Base 75W max.

T24-1

4130701EN3(-962 -710 -112)

(1) Med. Base LED 3000K,
 9W, 800 Lumen lamp incl.

T24-2 EN*



D

Brushed Nickel Finish (-962)
 Etched, White Inside Glass

FINISH CODES

- (-962) Brushed Nickel
- (-710) Bronze
- (-112) Midnight Black

A. FOUR LIGHT WALL / BATH

W: 32.5" H: 9.125" E: 6.625"
 Height from center of outlet box
 up: 6.625" down: 2.5"

DAMP +

4413704-962

(4) Medium Base 75W max.

T24-1

4413704EN3-962

(4) Med. Base LED 3000K,
 9W, 800 Lumen lamps incl.

T24-2 EN*



A

Brushed Nickel Finish (-962)
 Etched White Glass

B. THREE LIGHT WALL / BATH

W: 23.625" H: 9.125" E: 6.625"
 Height from center of outlet box
 up: 6.625" down: 2.5"

DAMP +

4413703(-05 -962 -778)

(3) Medium Base 75W max.

T24-1

4413703EN3-962

(3) Med. Base LED 3000K,
 9W, 800 Lumen lamps incl.

T24-2 EN*



B

Brushed Nickel Finish (-962)
 Etched White Glass

C. TWO LIGHT WALL / BATH

W: 16.125" H: 9.125" E: 6.625"
 Height from center of outlet box
 up: 6.625" down: 2.5"

DAMP +

4413702-962

(2) Medium Base 75W max.

T24-1

4413702EN3-962

(2) Med. Base LED 3000K,
 9W, 800 Lumen lamps incl.

T24-2 EN*



C

Brushed Nickel Finish (-962)
 Etched White Glass

D. ONE LIGHT WALL / BATH SCONCE

W: 5.75" H: 10.125" E: 6.625"
 Height from center of outlet box
 up: 7.625" down: 2.5"

DAMP +

4113701-962

(1) Medium Base 75W max.

T24-1

4113701EN3-962

(1) Med. Base LED 3000K,
 9W Bulb lamps incl.

T24-2 EN*



D

Brushed Nickel Finish (-962)
 Etched White Glass

FINISH CODES

(-962) Brushed Nickel



PRODUCT SHOWN: HETTINGER THREE LIGHT
WALL / BATH IN CHROME FINISH

A. FOUR LIGHT WALL / BATH

W: 29" H: 8" E: 6.25"
 Height from center of outlet box
 up: 5.75" down: 2.25"

DAMP +

4439104(-05 -962 -710 -112 -848)

(4) Medium Base 75W max.

T24-1

4439104EN3(-05 -962 -710 -112 -848)

(4) Med. Base LED 3000K,
 9W, 800 Lumen lamp incl.

T24-2 EN*



A

Satin Brass Finish (-848)
 Etched, White Inside Glass

B. THREE LIGHT WALL / BATH

W: 20.5" H: 8" E: 6.25"
 Height from center of outlet box
 up: 5.75" down: 2.25"

DAMP +

4439103(-05 -962 -710 -112 -848)

(3) Medium Base 75W max.

T24-1

4439103EN3(-05 -962 -710 -112 -848)

(3) Med. Base LED 3000K,
 9W, 800 Lumen lamp incl.

T24-2 EN*



B

Brushed Nickel Finish (-962)
 Etched, White Inside Glass

C. TWO LIGHT WALL / BATH

W: 13.5" H: 8" E: 5.75"
 Height from center of outlet box
 up: 5.75" down: 2.25"

DAMP +

4439102(-05 -962 -710 -112 -848)

(2) Medium Base 75W max.

T24-1

4439102EN3(-05 -962 -710 -112 -848)

(2) Med. Base LED 3000K,
 9W, 800 Lumen lamp incl.

T24-2 EN*



C

Midnight Black Finish (-112)
 Etched, White Inside Glass



Bronze Finish (-710)
 Etched, White Inside Glass

D. ONE LIGHT WALL / BATH SCONCE

W: 4.5" H: 8" E: 5"
 Height from center of outlet box
 up: 5.75" down: 2.25"

DAMP +

4139101(-05 -962 -710 -112 -848)

(1) Medium Base 75W max.

T24-1

4139101EN3(-05 -962 -710 -112 -848)

(1) Med. Base LED 3000K,
 9W, 800 Lumen lamp incl.

T24-2 EN*



D

Chrome Finish (-05)
 Etched, White Inside Glass

FINISH CODES

- (-05) Chrome
- (-962) Brushed Nickel
- (-710) Bronze
- (-112) Midnight Black
- (-848) Satin Brass



PRODUCT SHOWN: ALTURAS THREE LIGHT
WALL / BATH IN BRUSHED NICKEL FINISH

A. FOUR LIGHT WALL / BATH

W: 30.5" H: 9.25" E: 7.25"
 Height from center of outlet box
 up: 6.25" down: 3"

DAMP +

4424604(-05 -848 -962 -778 -112)

(4) Medium Base 75W max.

T24-1

4424604EN3(-05 -848 -962 -778 -112)

(4) Med. Base LED 3000K,
 9W, 800 Lumen lamp incl.

T24-2 EN*



A

Chrome Finish (-05)
 Etched, White Inside Glass

B. THREE LIGHT WALL / BATH

W: 22" H: 9.25" E: 7.5"
 Height from center of outlet box
 up: 6.25" down: 3"

DAMP +

4424603(-05 -848 -962 -778 -112)

(3) Medium Base 75W max.

T24-1

4424603EN3(-05 -848 -962 -778 -112)

(3) Med. Base LED 3000K,
 9W, 800 Lumen lamp incl.

T24-2 EN*



B

Satin Brass Finish (-848)
 Etched, White Inside Glass

C. TWO LIGHT WALL / BATH

W: 13.5" H: 9.25" E: 6.5"
 Height from center of outlet box
 up: 6.25" down: 3"

DAMP +

4424602(-05 -848 -962 -778 -112)

(2) Medium Base 75W max.

T24-1

4424602EN3(-05 -848 -962 -778 -112)

(2) Med. Base LED 3000K,
 9W, 800 Lumen lamp incl.

T24-2 EN*



C

Brushed Nickel Finish (-962)
 Etched, White Inside Glass



Midnight Black Finish (-112)
 Etched, White Inside Glass

D. ONE LIGHT WALL / BATH SCONCE

W: 4.5" H: 8.75" E: 6.25"
 Height from center of outlet box
 up: 5.75" down: 3"

DAMP +

4124601(-05 -848 -962 -778 -112)

(1) Medium Base 75W max.

T24-1

4124601EN3(-05 -848 -962 -778 -112)

(1) Med. Base LED 3000K,
 9W, 800 Lumen lamp incl.

T24-2 EN*



D

Pewter Bronze Finish (-778)
 Etched, White Inside Glass

FINISH CODES

- (-05) Chrome
- (-848) Satin Brass
- (-962) Brushed Nickel
- (-778) Pewter Bronze
- (-112) Midnight Black

A. FOUR LIGHT WALL / BATH

W: 34" H: 8.125" E: 6.75"
 Height from center of outlet box
 up: 5.625" down: 2.5"

DAMP +

4421604(-05 -962 -710 -112)

(4) Medium Base 75W max.

T24-1

4421604EN3(-05 -962 -710 -112)

(4) Med. Base LED 3000K,
 9W, 800 Lumen lamps incl.

T24-2 EN *



A

Chrome Finish (-05)
 Etched, White Inside Glass

B. THREE LIGHT WALL / BATH

W: 24" H: 8.125" E: 6.75"
 Height from center of outlet box
 up: 5.625" down: 2.5"

DAMP +

4421603(-05 -962 -710 -112)

(3) Medium Base 75W max.

T24-1

4421603EN3(-05 -962 -710 -112)

(3) Med. Base LED 3000K,
 9W, 800 Lumen lamps incl.

T24-2 EN *



B

Brushed Nickel Finish (-962)
 Etched, White Inside Glass

C. TWO LIGHT WALL / BATH

W: 14.625" H: 8.125" E: 6.75"
 Height from center of outlet box
 up: 5.625" down: 2.5"

DAMP +

4421602(-05 -962 -710 -112)

(2) Medium Base 75W max.

T24-1

4421602EN3(-05 -962 -710 -112)

(2) Med. Base LED 3000K,
 9W, 800 Lumen lamps incl.

T24-2 EN *



C

Bronze Finish (-710)
 Etched, White Inside Glass

D. ONE LIGHT WALL / BATH SCNCE

W: 5" H: 8.125" E: 7.375"
 Height from center of outlet box
 up: 4.625" down: 3.5"

DAMP +

4121601(-05 -962 -710 -112)

(1) Medium Base 75W max.

T24-1

4121601EN3(-05 -962 -710 -112)

(1) Med. Base LED 3000K,
 9W, 800 Lumen lamp incl.

T24-2 EN *



D

Midnight Black Finish (-112)
 Etched, White Inside Glass

FINISH CODES

- (-05) Chrome
- (-962) Brushed Nickel
- (-710) Bronze
- (-112) Midnight Black

A. THREE LIGHT VANITY

W: 23" H: 9.75" E: 6.5"
 Height from center of outlet box
 up: 7.25"

DAMP

VS23303SN/CH

(3) Medium Base 75W max.

B. TWO LIGHT VANITY

W: 14" H: 9.75" E: 6.5"
 Height from center of outlet box
 up: 7.25"

DAMP

VS23302SN/CH

(2) Medium Base 75W max.

C. ONE LIGHT SCONCE

W: 5" H: 9.75" E: 6.5"
 Height from center of outlet box
 up: 7.25"

DAMP

VS23301SN/CH

(1) Medium A19 75 max



A

Satin Nickel / Chrome Finish (SN/CH)
 White Opal Etched Glass



B

Satin Nickel / Chrome Finish (SN/CH)
 White Opal Etched Glass



C

Satin Nickel / Chrome Finish
 White Opal Etched Glass

FINISH CODE

(SN/CH) Satin Nickel / Chrome



PRODUCT SHOWN: FRANPORT ONE LIGHT
WALL / BATH SCONCE IN BRONZE FINISH

A. FOUR LIGHT WALL / BATH

W: 29.375" H: 8.25" E: 6.25"
 Height from center of outlet box
 up: 5.75" down: 2.5"

DAMP +

4428904(-05 -962 -710 -112)

(4) Medium Base 75W max.

T24-1

4428904EN3(-05 -962 -710 -112)

(4) Med. Base LED 3000K,
 9W, 800 Lumen lamp incl.

T24-2 EN*



A

Chrome Finish (-05)
 Etched, White Inside Glass

B. THREE LIGHT WALL / BATH

W: 21" H: 8.25" E: 6.25"
 Height from center of outlet box
 up: 5.75" down: 2.5"

DAMP +

4428903(-05 -962 -710 -112)

(3) Medium Base 75W max.

T24-1

4428903EN3(-05 -962 -710 -112)

(3) Med. Base LED 3000K,
 9W, 800 Lumen lamp incl.

T24-2 EN*



B

Bronze Finish (-710)
 Etched, White Inside Glass

C. TWO LIGHT WALL / BATH

W: 13.25" H: 8.25" E: 6.25"
 Height from center of outlet box
 up: 5.75" down: 2.5"

DAMP +

4428902(-05 -962 -710 -112)

(2) Medium Base 75W max.

T24-1

4428902EN3(-05 -962 -710 -112)

(2) Med. Base LED 3000K,
 9W, 800 Lumen lamp incl.

T24-2 EN*



C

Midnight Black Finish (-112)
 Etched, White Inside Glass

D. ONE LIGHT WALL / BATH SCONCE

W: 5" H: 8" E: 6.875"
 Height from center of outlet box
 up: 4" down: 4"

DAMP +

4128901(-05 -962 -710 -112)

(1) Medium Base 75W max.

T24-1

4128901EN3(-05 -962 -710 -112)

(1) Med. Base LED 3000K,
 9W, 800 Lumen lamp incl.

T24-2 EN*



D

Brushed Nickel Finish (-962)
 Etched, White Inside Glass

FINISH CODES

- (-05) Chrome
- (-962) Brushed Nickel
- (-710) Bronze
- (-112) Midnight Black



PRODUCT SHOWN: BAYFIELD ONE LIGHT
WALL / BATH SCONCE IN BRUSHED NICKEL FINISH

A. FOUR LIGHT WALL / BATH

W: 27.5" H: 7.75" E: 6.75"
 Height from center of outlet box
 up: 5.5" down: 2.25"

DAMP +

4411604(-05 -962 -710)

(4) Medium Base 75W max.

T24-1

4411604EN3(-05 -962 -710)

(4) Med. Base LED 3000K,
 9W, 800 Lumen lamps incl.

T24-2 EN*



A

Chrome Finish (-05)
 Etched, White Inside Glass

B. THREE LIGHT WALL / BATH

W: 20" H: 7.75" E: 6.75"
 Height from center of outlet box
 up: 5.5" down: 2.25"

DAMP +

4411603(-05 -962 -710)

(3) Medium Base 75W max.

T24-1

4411603EN3(-05 -962 -710)

(3) Med. Base LED 3000K,
 9W, 800 Lumen lamps incl.

T24-2 EN*



B

Brushed Nickel Finish (-962)
 Etched, White Inside Glass

C. TWO LIGHT WALL / BATH

W: 13.25" H: 7.75" E: 6.75"
 Height from center of outlet box
 up: 5.5" down: 2.25"

DAMP +

4411602(-05 -962 -710)

(2) Medium Base 75W max.

T24-1

4411602EN3(-05 -962 -710)

(2) Med. Base LED 3000K,
 9W, 800 Lumen lamps incl.

T24-2 EN*



C

Bronze Finish (-710)
 Etched, White Inside Glass

D. ONE LIGHT WALL / BATH SCONCE

W: 5" H: 7.75" E: 6.25"
 Height from center of outlet box
 up: 4.5" down: 3.25"

DAMP +

4111601(-05 -962 -710)

(1) Medium Base 75W max.

T24-1

4111601EN3(-05 -962 -710)

(1) Med. Base LED 3000K,
 9W, 800 Lumen lamp incl.

T24-2 EN*



D

Chrome Finish (-05)
 Etched, White Inside Glass

FINISH CODES

- (-05) Chrome
- (-962) Brushed Nickel
- (-710) Bronze

A. FOUR LIGHT WALL / BATH

W: 33.5" H: 11.25" E: 6.5"
 Height from center of outlet box
 up: 6" down: 5.25"

DAMP +

4424504(-962 -710)

(4) Medium Base 75W max.

T24-1

4424504EN3(-962 -710)

(4) Med. Base LED 3000K,
 9W, 800 Lumen lamps incl.

T24-2 EN *



A

Brushed Nickel Finish (-962)
 Satin Etched Glass

B. THREE LIGHT WALL / BATH

W: 24" H: 10.75" E: 6.5"
 Height from center of outlet box
 up: 6" down: 4.75"

DAMP +

4424503(-962 -710)

(3) Medium Base 75W max.

T24-1

4424503EN3(-962 -710)

(3) Med. Base LED 3000K,
 9W, 800 Lumen lamps incl.

T24-2 EN *



B

Bronze Finish (-710)
 Satin Etched Glass

C. TWO LIGHT WALL / BATH

W: 14.5" H: 9.75" E: 6.5"
 Height from center of outlet box
 up: 6" down: 3.75"

DAMP +

4424502(-962 -710)

(2) Medium Base 75W max.

T24-1

4424502EN3(-962 -710)

(2) Med. Base LED 3000K,
 9W, 800 Lumen lamps incl.

T24-2 EN *



C

Brushed Nickel Finish (-962)
 Satin Etched Glass

D. ONE LIGHT WALL / BATH SCNCE

W: 5.25" H: 10.25" E: 6.75"
 Height from center of outlet box
 up: 7.25" down: 3"

DAMP +

4124501(-962 -710)

(1) Medium Base 75W max.

T24-1

4124501EN3(-962 -710)

(1) Med. Base LED 3000K,
 9W, 800 Lumen lamp incl.

T24-2 EN *



D

Bronze Finish (-710)
 Satin Etched Glass

FINISH CODES

(-962) Brushed Nickel
 (-710) Bronze

A. FOUR LIGHT WALL / BATH

W: 32" H: 6.25" E: 7.5"
 Height from center of outlet box
 up: 3.75" down: 2.5"

DAMP +

4439004(-962 -710)

(4) Medium Base 75W max.

T24-1

4439004EN3(-962 -710)

(4) Med. Base LED 3000K,
 9W, 800 Lumen lamps incl.

T24-2 EN*



A

Brushed Nickel Finish (-962)
 Satin Etched Glass

B. THREE LIGHT WALL / BATH

W: 23.25" H: 6.25" E: 7.5"
 Height from center of outlet box
 up: 3.75" down: 2.5"

DAMP +

4439003(-962 -710)

(3) Medium Base 75W max.

T24-1

4439003EN3(-962 -710)

(3) Med. Base LED 3000K,
 9W, 800 Lumen lamps incl.

T24-2 EN*



B

Bronze Finish (-710)
 Satin Etched Glass

C. TWO LIGHT WALL / BATH

W: 14.75" H: 6.25" E: 7.5"
 Height from center of outlet box
 up: 3.75" down: 2.5"

DAMP +

4439002(-962 -710)

(2) Medium Base 75W max.

T24-1

4439002EN3(-962 -710)

(2) Med. Base LED 3000K,
 9W, 800 Lumen lamps incl.

T24-2 EN*



C

Brushed Nickel Finish (-962)
 Satin Etched Glass

D. ONE LIGHT WALL / BATH SCONCE

W: 6" H: 6.25" E: 7.5"
 Height from center of outlet box
 up: 3.75" down: 2.5"

DAMP +

4139001(-962 -710)

(1) Medium Base 75W max.

T24-1

4139001EN3(-962 -710)

(1) Med. Base LED 3000K,
 9W, 800 Lumen lamp incl.

T24-2 EN*



D

Bronze Finish (-710)
 Satin Etched Glass

FINISH CODES

(-962) Brushed Nickel
 (-710) Bronze



PRODUCT SHOWN: ABBOTT THREE LIGHT
VANITY IN BURNISHED BRASS FINISH

A. THREE LIGHT VANITY

W: 24.125" H: 5.5" E: 7"
 Height from center of outlet box
 up: 3.125" down: 2.375"

DAMP +

VS2463BBS

(3) LED G9 T4 4.5W Bulbs incl.
 T24-1

B. ONE LIGHT SCONCE

W: 6.375" H: 7.75" E: 8.125"
 Height from center of outlet box
 up: 4.25" down: 3.5"

DAMP +

VS2461BBS

(1) Candelabra Torpedo 60W max.
 T24-1



A

Burnished Brass Finish (BBS)
 White Glass



B

Burnished Brass Finish (BBS)
 White Glass

FINISH CODE

(BBS) Burnished Brass

**A. LARGE LED
WALL / BATH**

W: 38" H: 5" E: 3.75"
Height from center of outlet box
horizontal: 2.5" vertical: 19"

DAMP ADA +

4635793S-04

(3) LED Integrated Array
11W Bulb lamp incl.

LED



A

Satin Aluminum Finish (-04)
Frosted Acrylic Diffuser &
Clear Acrylic Outer Shade

**B. MEDIUM LED
WALL / BATH**

W: 26" H: 5" E: 3.75"
Height from center of outlet box
horizontal: 2.5" vertical: 13"

DAMP ADA +

4535793S-04

(2) LED Integrated Array
11W Bulb lamps incl.

LED



B

Satin Aluminum Finish (-04)
Frosted Acrylic Diffuser &
Clear Acrylic Outer Shade

**C. SMALL LED
WALL / BATH**

W: 20" H: 5" E: 3.75"
Height from center of outlet box
horizontal: 2.5" vertical: 10"

DAMP ADA +

4435793S-04

(1) LED Integrated Array
16.5W Bulb lamp incl.

LED



C

Satin Aluminum Finish (-04)
Frosted Acrylic Diffuser &
Clear Acrylic Outer Shade

FINISH CODE

(-04) Satin Aluminum

A. MEDIUM LED WALL / BATH

W: 23.25" H: 4.25" E: 5"
 Height from center of outlet box
 horizontal: 2.25" vertical: 11.75"

DAMP +

4422991S-962

(1) LED Integrated Array
 18W Bulb lamps incl.

T24-3 LED



A

Brushed Nickel Finish (-962)
 White Acrylic Diffuser

B. SMALL LED WALL / BATH

W: 18" H: 4.25" E: 5"
 Height from center of outlet box
 up: 2.25" down: 21"

DAMP +

4322991S-962

(1) LED Integrated Array
 14W Bulb lamps incl.

T24-1 LED

C. LED WALL / BATH SCONCE

W: 4.5" H: 8" E: 4"
 Height from center of outlet box
 up: 4.5" down: 3.5"

DAMP ADA +

4122991S-962

(1) LED Integrated Array
 8W Bulb lamps incl.

T24-3 LED



B

Brushed Nickel Finish (-962)
 White Acrylic Diffuser



C

Brushed Nickel Finish (-962)
 White Acrylic Diffuser

FINISH CODE

(-962) Brushed Nickel

A. EIGHT LIGHT WALL / BATH

W: 48" H: 4.25" E: 2.25"
 Height from center of outlet box
 horizontal: 2.25" vertical: 24"

DAMP +

4740(-05 -98)

(8) Medium Base
 G25 75W max.

T24-1

B. SIX LIGHT WALL / BATH

W: 36" H: 4.25" E: 2.25"
 Height from center of outlet box
 horizontal: 2.25" vertical: 18"

DAMP +

4739(-05 -98)

(6) Medium Base
 G25 75W max.

T24-1



A

Chrome Finish (-05)



B

Brushed Stainless Finish (-98)

FINISH CODES

- (-05) Chrome
- (-98) Brushed Stainless

C. FIVE LIGHT WALL / BATH

W: 30" H: 4.25" E: 2.25"
 Height from center of outlet box
 horizontal: 2.25" vertical: 15"

DAMP +

4735(-05 -98)

(5) Medium Base
 G25 75W max.

T24-1

D. FOUR LIGHT WALL / BATH

W: 24" H: 4.25" E: 2.25"
 Height from center of outlet box
 horizontal: 2.25" vertical: 12"

DAMP +

4738(-05 -98)

(4) Medium Base
 G25 75W max.

T24-1



C

Chrome Finish (-05)

E. THREE LIGHT WALL / BATH

W: 18" H: 4.25" E: 2.25"
 Height from center of outlet box
 horizontal: 2.25" vertical: 9"

DAMP +

4737(-05 -98)

(3) Medium Base
 G25 75W max.

T24-1



D

Brushed Stainless Finish (-98)



E

Chrome Finish (-05)

FINISH CODES

- (-05) Chrome
- (-98) Brushed Stainless

A. RECTANGULAR MIRROR

W: 27" H: 37" E: 1"

MR1107AF



A

Antique Forged Iron Finish (AF)

FINISH CODE

(AF) Antique Forged Iron

INFINITY

A. LARGE RECTANGULAR MIRROR

W: 24" H: 36" E: .5"

MR1154

B. MEDIUM RECTANGULAR MIRROR

W: 22" H: 28" E: .5"

MR1152



A

Beveled Mirror Glass



B

Beveled Mirror Glass

A. OVAL MIRROR

W: 24" H: 32.875" E: 1"

MR1119ORB



A

FINISH CODE

(ORB) Oil Rubbed Bronze

Oil Rubbed Bronze Finish (ORB)

KIT

A. OVAL MIRROR

W: 24" H: 36" E: 2"

MR1300(BBS MBK PN)

B. ROUND MIRROR

D: 30" E: 2"

MR1301(BBS MBK PN)

C. RECTANGULAR MIRROR

W: 24" H: 36" E: 2"

MR1303(BBS MBK PN)

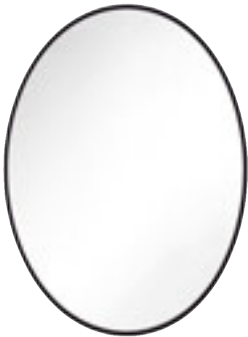

A

Midnight Black (MBK)



B

Burnished Brass (BBS)



C

Polished Nickel (PN)

FINISH CODES

(BBS) Burnished Brass
(MBK) Midnight Black
(PN) Polished Nickel



PRODUCT SHOWN: LOUVER LED HALL LIGHTS IN ANTIQUE BRONZE FINISH

LED STEP AND HALL LIGHTING

LED STEP / HALL LIGHTING

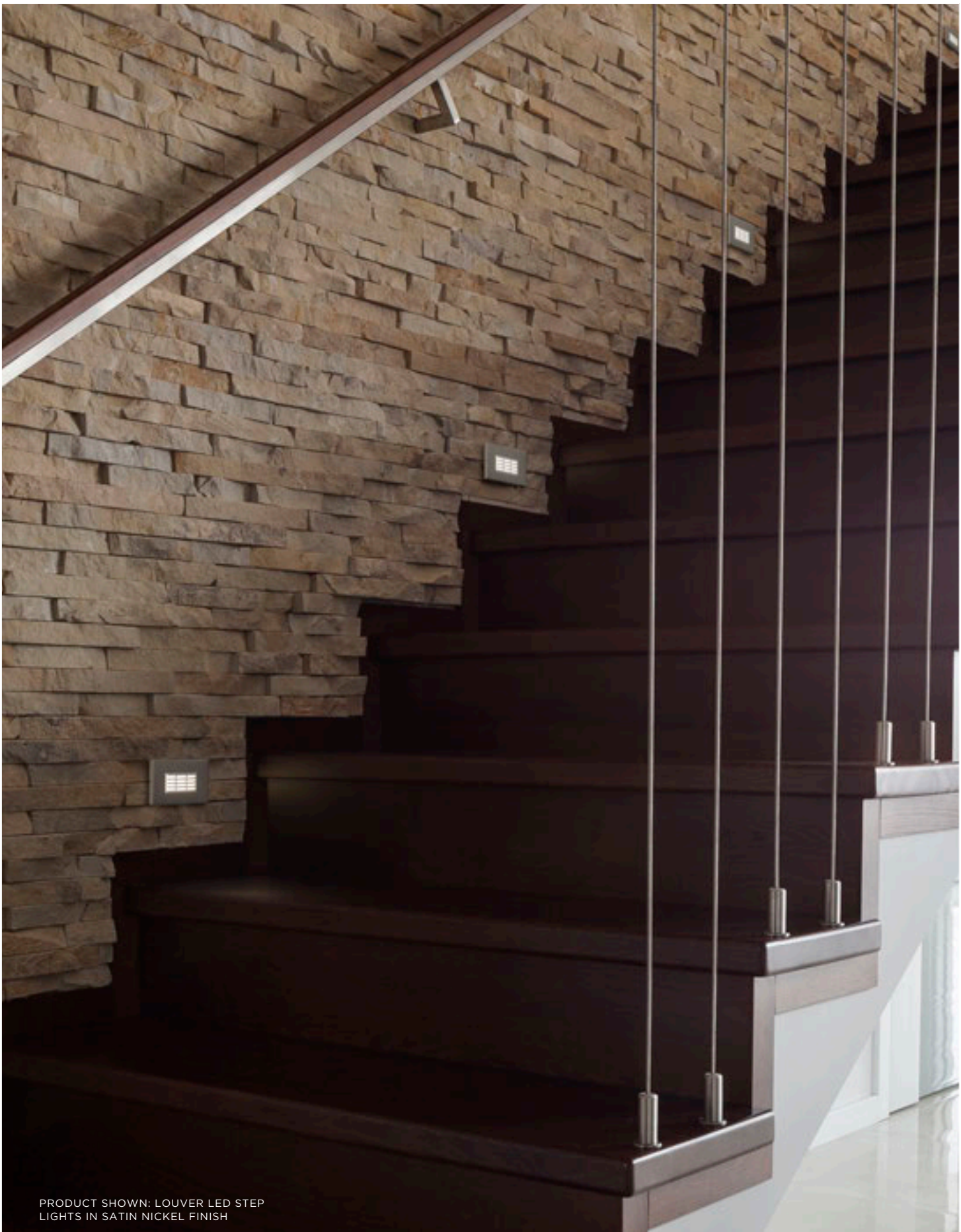

PRODUCT SHOWN: LOUVER LED STEP
LIGHTS IN SATIN NICKEL FINISH

LED STEP AND HALL LIGHTING

LED Step and LED Hall Lights from Generation Lighting are a perfectly balanced blend of the latest LED light guide technology with high quality craftsmanship and beautiful design. We've taken expertise from our broad line of task, accent, and undercabinet lighting systems and applied it to a compact form factor to help you make an even bigger impact on the spaces you illuminate.

Extensive use of high quality, die-cast metal and premium finishes ensure enduring aesthetic appeal while being backed by a five-year warranty. Our LED Step and LED Hall Lights come in three finishes, White, Satin Nickel, and Antique Bronze, as well as three different styles, the Louver, the Tarpa, and the Vitra.



LOUVER

A modern, miniature interpretation of a classic louvered design provides great directional light control.



TARPA

This handsome design inspired by sleek metal awnings deliver ultimate directional light control.



VITRA

A simple, yet sophisticated design that maximizes light output and delivers a clean, crisp aesthetic.

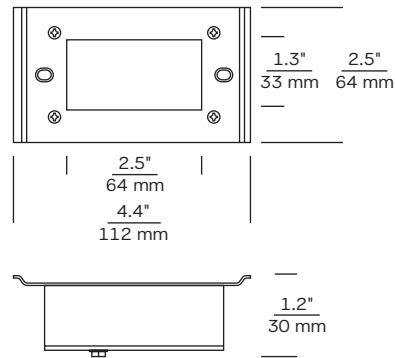

Style	LOUVER	TARPA	VITRA
120V	93401S(-15 -849 -171)	93403S(-15 -849 -171)	93405S(-15 -849 -171)
120V Amber Light	93481S(-15 -849 -171)	93483S(-15 -849 -171)	93485S(-15 -849 -171)
Finishes	WHITE (-15) SATIN NICKEL (-849) ANTIQU BRONZE (-171)	WHITE (-15) SATIN NICKEL (-849) ANTIQU BRONZE (-171)	WHITE (-15) SATIN NICKEL (-849) ANTIQU BRONZE (-171)
Face Plate Dimensions	L: 4.7" H: 3" D: .37"	L: 4.7" H: 3" D: .94"	L: 4.7" H: 3" D: .27"
Input Voltage	120V		
Delivered Lumens	UP TO 90		
Power Consumption	3.3W		
Efficacy	36 LM/W		
Color Temperature	3000K		
Color Rendering Index	90 CRI		
Rated Average Life	50,000 HRS TO 70%		
Dimmable	DOWN TO 10% WITH ELV DIMMER (120V, 3000K UNITS ONLY)		
Listings	SUITABLE FOR INDOOR OR OUTDOOR INSTALLATIONS. CETL AND IP-65 WET		
Installation	INSTALLS IN A SINGLE, 2" X 4", SWITCH BOX WITH A MINIMUM DEPTH OF 2"		

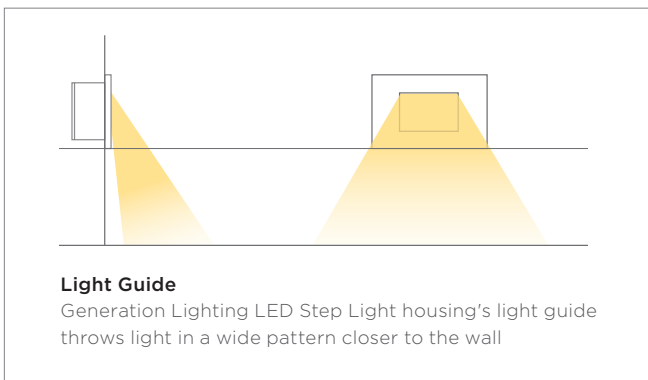

Each housing's LED light guide is purpose-built to push the light down towards the floor at an assertive angle for excellent coverage as close to the wall as possible while throwing the remaining light outward for soft area illumination.

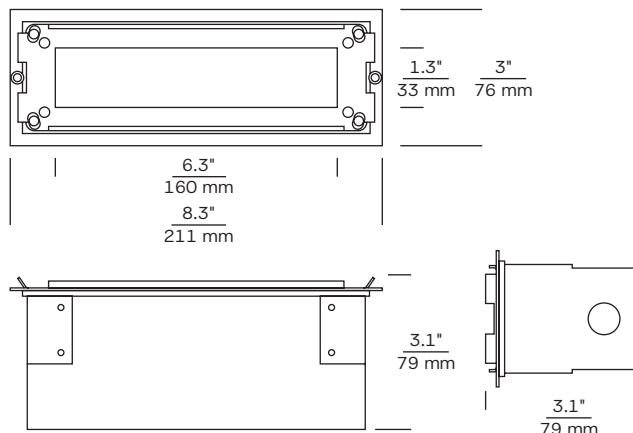

Style	LOUVER	TARPA	VITRA
120V	94401S(-15 -849 -171)	94403S(-849 -171)	94405S(-15 -849 -171)
120V Amber Light	94481S(-15 -849 -171)	94483S(-849 -171)	94485S(-15 -849 -171)
Finishes	WHITE (-15) SATIN NICKEL (-849) ANTIQUÉ BRONZE (-171)	SATIN NICKEL (-849) ANTIQUÉ BRONZE (-171)	WHITE (-15) SATIN NICKEL (-849) ANTIQUÉ BRONZE (-171)
Face Plate Dimensions	L: 4.7" H: 3" D: .37"	L: 4.7" H: 3" D: .94"	L: 4.7" H: 3" D: .27"
Input Voltage	120V		
Delivered Lumens	UP TO 300		
Power Consumption	8.6W		
Efficacy	35 LM/W		
Color Temperature	3000K		
Color Rendering Index	90 CRI		
Rated Average Life	50,000 HRS TO 70%		
Dimmable	DOWN TO 10% WITH ELV DIMMER (120V, 3000K UNITS ONLY)		
Listings	SUITABLE FOR INDOOR OR OUTDOOR INSTALLATIONS. CETL AND IP-65 WET		
Installation	SUITABLE FOR BRICK AND POURED CONCRETE		

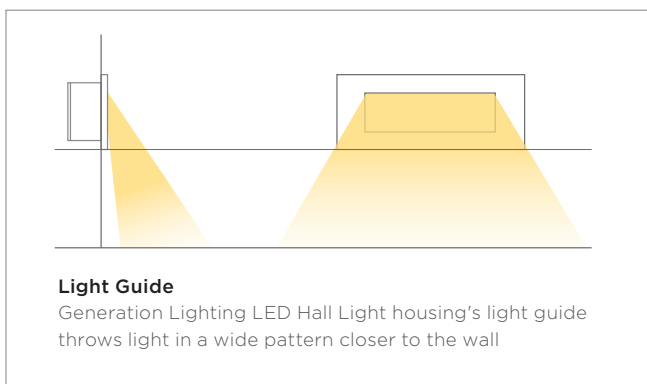

Each housing's LED light guide is purpose-built to push the light down towards the floor at an assertive angle for excellent coverage as close to the wall as possible while throwing the remaining light outward for soft area illumination.

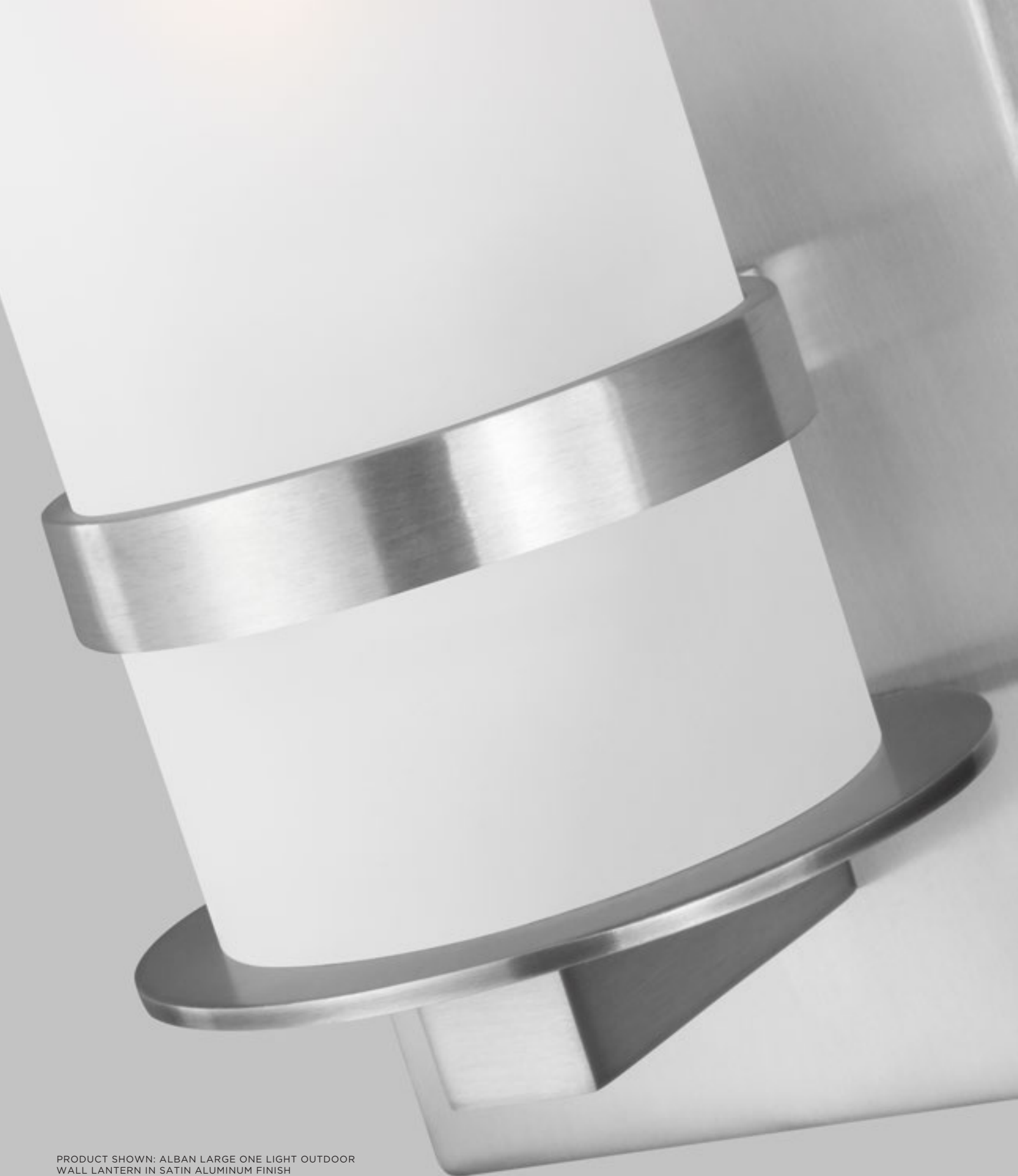

PRODUCT SHOWN: ALBAN LARGE ONE LIGHT OUTDOOR
WALL LANTERN IN SATIN ALUMINUM FINISH

OUTDOOR



PRODUCTS SHOWN: ALBAN MEDIUM ONE LIGHT OUTDOOR WALL LANTERN WITH SQUARE GLASS IN ANTIQUE BRONZE FINISH AND CANFIELD THREE LIGHT SEMI-FLUSH MOUNT IN BRONZE FINISH



OUTDOOR WALL LANTERNS

PRODUCT	NO LAMP OPTION	LAMP INCLUDED
A. ROUND LARGE ONE LIGHT W: 8" H: 24.625" E: 6.875" Height from center of outlet box up: 12.3125" WET	8718301(-04 -71 -12) (1) Medium Base 60W max. T24-1	8718301EN3(-04 -71 -12) (1) Med. Base LED 3000K, 9W, 800 Lumen lamp incl. T24-1 EN*
B. ROUND MEDIUM ONE LIGHT W: 6" H: 18" E: 5.5" Height from center of outlet box up: 9" WET	8618301(-04 -71 -12) (1) Medium Base 60W max. T24-1	8618301EN3(-04 -71 -12) (1) Med. Base LED 3000K, 9W, 800 Lumen lamp incl. T24-2 EN*
C. ROUND SMALL ONE LIGHT W: 4.5" H: 14" E: 4.25" Height from center of outlet box up: 7" WET	8518301(-04 -71 -12) (1) Medium Base 60W max. T24-1	8518301EN3(-04 -71 -12) (1) Med. Base LED 3000K, 9W, 800 Lumen lamp incl. T24-1 EN*
D. SQUARE LARGE ONE LIGHT W: 8" H: 24.625" E: 6.875" Height from center of outlet box up: 12.3125" WET	8720701(-04 -71) (1) Medium Base 60W max. T24-1	8720701EN3(-04 -71) (1) Med. Base LED 3000K, 9W, 800 Lumen lamp incl. T24-1 EN*
E. SQUARE MEDIUM ONE LIGHT W: 6" H: 18" E: 5.5" Height from center of outlet box up: 9" WET	8620701(-71-12 -04) (1) Medium Base 60W max. T24-1	8620701EN3(-71-12 -04) (1) Med. Base LED 3000K, 9W, 800 Lumen lamp incl. T24-2 EN*
F. SQUARE SMALL ONE LIGHT W: 4.5" H: 14" E: 4.25" Height from center of outlet box up: 7" WET	8520701(-04 -71 -12) (1) Medium Base 60W max. T24-1	8520701EN3(-04 -71 -12) (1) Med. Base LED 3000K, 9W, 800 Lumen lamp incl. T24-1 EN*

FINISH CODES

- (-04) Satin Aluminum
- (-71) Antique Bronze
- (-12) Black



PRODUCT SHOWN: RENVILLE SMALL ONE LIGHT
OUTDOOR WALL LANTERN IN BLACK FINISH

**A. LARGE ONE LIGHT
OUTDOOR WALL LANTERN**

W: 7" H: 10.25" E: 8"
Height from center of outlet box
up: 3.5"

WET

8638601(-71 -12)

(1) Medium Base 100W max.

T24-1

8638601EN3(-71 -12)

(1) Med. Base LED 3000K,
9W, 800 Lumen lamp incl.

T24-2 EN*

**B. SMALL ONE LIGHT
OUTDOOR WALL LANTERN**

W: 5.25" H: 7.375" E: 5.75"
Height from center of outlet box
up: 2.5"

WET

8538601(-71 -12)

(1) Medium Base 60W max.

T24-1

8538601EN3(-71 -12)

(1) Med. Base LED 3000K,
9W, 800 Lumen lamp incl.

T24-2 EN*



A

Antique Bronze Finish (-71)
Satin Etched Glass



Black Finish (-12)
Satin Etched Glass



B

Antique Bronze Finish (-71)
Satin Etched Glass



Black Finish (-12)
Satin Etched Glass

FINISH CODES

- (-71) Antique Bronze
- (-12) Black



PRODUCT SHOWN: WILBURN MEDIUM ONE LIGHT
OUTDOOR WALL LANTERN IN BLACK FINISH

**A. EXTRA LARGE ONE LIGHT
OUTDOOR WALL LANTERN**

W: 12.625" H: 24" E: 14.25"
Height from center of outlet box
up: 3.75"

WET

8890901(-71 -12)

(1) Medium Base 75W max.

T24-1

8890901EN3(-71 -12)

(1) Med. Base LED 3000K,
9W, 800 Lumen lamp incl.

T24-2 EN *

8890901D(-71 -12)

(1) Medium Base 75W max.

T24-1 ☾

8890901DEN3(-71 -12)

(1) Med. Base LED 3000K,
9W, 800 Lumen lamp incl.

T24-2 EN * ☾

**B. LARGE ONE LIGHT
OUTDOOR WALL LANTERN**

W: 10" H: 20" E: 11.5"
Height from center of outlet box
up: 2.875"

WET

8790901(-71 -12)

(1) Medium Base 75W max.

T24-1

8790901EN3(-71 -12)

(1) Med. Base LED 3000K,
9W, 800 Lumen lamp incl.

T24-2 EN *

8790901D-12

(1) Medium Base 75W max.

T24-1 ☾

8790901DEN3(-71 -12)

(1) Med. Base LED 3000K,
9W, 800 Lumen lamp incl.

T24-2 EN * ☾



A

Antique Bronze Finish (-71)
White Aluminum / Satin Etched Glass



B

Black Finish (-12)
White Aluminum / Satin Etched Glass

FINISH CODES

- (-71) Antique Bronze
- (-12) Black

**C. MEDIUM ONE LIGHT
OUTDOOR WALL LANTERN**

W: 8" H: 13.5" E: 9.375"
Height from center of outlet box
up: 2.375"

WET

8690901(-71 -12)

(1) Medium Base 60W max.

T24-1

8690901EN3(-71 -12)

(1) Med. Base LED 3000K,
9W, 800 Lumen lamp incl.

T24-2 EN*

8690901D(-71 -12)

(1) Medium Base 60W max.

T24-1 ☾

8690901DEN3(-71 -12)

(1) Med. Base LED 3000K,
9W, 800 Lumen lamp incl.

T24-2 EN* ☾



C

Antique Bronze Finish (-71)
Etched / White Inside Glass



Black Finish (-12)
Etched, White Inside Glass

**D. SMALL ONE LIGHT
OUTDOOR WALL LANTERN**

W: 6" H: 10.25" E: 7.375"
Height from center of outlet box
up: 2.375"

WET

8590901(-71 -12)

(1) Medium Base 60W max.

T24-1

8590901EN3(-71 -12)

(1) Med. Base LED 3000K,
9W, 800 Lumen lamp incl.

T24-2 EN*

8590901D(-71 -12)

(1) Medium Base 60W max.

T24-1 ☾

8590901DEN3(-71 -12)

(1) Med. Base LED 3000K,
9W, 800 Lumen lamp incl.

T24-2 EN* ☾



D

Antique Bronze Finish (-71)
Etched / White Inside Glass



Black Finish (-12)
Etched / White Inside Glass

FINISH CODES

(-71) Antique Bronze
(-12) Black

E. TWO LIGHT OUTDOOR FLUSH MOUNT

D: 13" H: 5.5"

DAMP

7890902(-71 -12)

(2) Medium Base 40W max.

T24-1

7890902EN3(-71 -12)

(2) Med. Base LED 3000K, 9W, 800 Lumen lamp incl.

T24-2 EN*



E

Antique Bronze Finish (-71)
Etched, White Inside Glass

F. ONE LIGHT OUTDOOR POST LANTERN

D: 8" H: 16.125"

WET

8290901(-71 -12)

(1) Medium Base 60W max.

T24-1

8290901EN3(-71 -12)

(1) Med. Base LED 3000K, 9W, 800 Lumen lamp incl.

T24-2 EN*



F

Black Finish (-12)
Etched, White Inside Glass

G. ONE LIGHT OUTDOOR PENDANT LANTERN

D: 8" H: 14"

6' of Wire pre-laced through 3' of Chain

DAMP

6290901(-71 -12)

(1) Medium Base 60W max.

T24-1

6290901EN3(-71 -12)

(1) Med. Base LED 3000K, 9W, 800 Lumen lamp incl.

T24-2 EN*



G

Antique Bronze Finish (-71)
Etched, White Inside Glass

FINISH CODES

- (-71) Antique Bronze
- (-12) Black



PRODUCT SHOWN: TYBEE LARGE ONE LIGHT OUTDOOR WALL LANTERN IN ANTIQUE BRONZE FINISH

**A. EXTRA LARGE ONE LIGHT
OUTDOOR WALL LANTERN**

W: 12" H: 22.25" E: 13.25"
Height from center of outlet box up: 3.875"

WET

8808901(-12 -71)

(1) Medium A19 75W max.

T24-1

8808901EN7(-12 -71)

(1) Med. Base LED 2700K, 8W, 800 Lumen lamps incl.

T24-2 EN*

**B. LARGE ONE LIGHT
OUTDOOR WALL LANTERN**

W: 10" H: 18.625" E: 11.25"
Height from center of outlet box up: 3.75"

WET

8708901(-12 -71)

(1) Medium A19 75W max.

T24-1

8708901EN7(-12 -71)

(1) Med. Base LED 2700K, 8W, 800 Lumen lamps incl.

T24-2 EN*



A

Black Finish (-12)
Clear Glass



B

Antique Bronze Finish (-71)
Clear Glass

**C. MEDIUM ONE LIGHT
OUTDOOR WALL LANTERN**

W: 8.5" H: 15.5" E: 9.625"
Height from center of outlet box up: 3.5"

WET

8608901(-12 -71)

(1) Medium A19 75W max.

T24-1

8608901EN7(-12 -71)

(1) Med. Base LED 2700K, 8W, 800 Lumen lamps incl.

T24-2 EN*



C

Black Finish (-12)
Clear Glass

**D. SMALL ONE LIGHT
OUTDOOR WALL LANTERN**

W: 6" H: 11.625" E: 7.25"
Height from center of outlet box up: 3.5"

WET

8508901(-12 -71)

(1) Medium A19 75W max.

T24-1

8508901EN7(-12 -71)

(1) Med. Base LED 2700K, 8W, 800 Lumen lamps incl.

T24-2 EN*



D

Antique Bronze Finish (-71)
Clear Glass

E. ONE LIGHT OUTDOOR PENDANT

D: 8.5" W: 8.5" H: 15.875"
6" of wire pre-laced through 3' of chain

DAMP

6208901(-12 -71)

(1) Medium A19 75W max.

T24-1

6208901EN7(-12 -71)

(1) Med. Base LED 2700K, 8W, 800 Lumen lamps incl.

T24-2 EN*



E

Black Finish (-12)
Clear Glass

FINISH CODES

- (-12) Black
- (-71) Antique Bronze



PRODUCT SHOWN: TOMEK MEDIUM ONE LIGHT
OUTDOOR WALL LANTERN IN BLACK FINISH

**A. LARGE ONE LIGHT
OUTDOOR WALL LANTERN**

W: 10.5" H: 18" E: 12.375"
Height from center of outlet box up: 3"

WET

8752701(-71 -12)

(1) Medium Base 75W max.

T24-1

8752701EN3(-71 -12)

(1) Med. Base LED 3000K,
9W, 800 Lumen lamp incl.

T24-2 EN*



A

Antique Bronze Finish (-71)
Etched, White Inside Glass



B

Black Finish (-12)
Etched, White Inside Glass

**B. MEDIUM ONE LIGHT
OUTDOOR WALL LANTERN**

W: 8.375" H: 14" E: 9.875"
Height from center of outlet box
up: 2.75"

WET

8652701(-71 -12)

(1) Medium Base 75W max.

T24-1

8652701EN3(-71 -12)

(1) Med. Base LED 3000K,
9W, 800 Lumen lamp incl.

T24-2 EN*

**C. SMALL ONE LIGHT
OUTDOOR WALL LANTERN**

W: 6.75" H: 10.625" E: 8.375"
Height from center of outlet box
up: 2.25"

WET

8552701(-71 -12)

(1) Medium Base 75W max.

T24-1

8552701EN3(-71 -12)

(1) Med. Base LED 3000K,
9W, 800 Lumen lamp incl.

T24-2 EN*



C

Antique Bronze Finish (-71)
Etched, White Inside Glass



D

Black Finish (-12)
Etched, White Inside Glass

**D. ONE LIGHT
OUTDOOR POST LANTERN**

L: 8.375" W: 8.375" H: 15.375"

WET

8252701(-12)

(1) Medium Base 75W max.

T24-1

8252701EN3(-12)

(1) Med. Base LED 3000K,
9W, 800 Lumen lamp incl.

T24-2 EN*

FINISH CODES

(-71) Antique Bronze
(-12) Black

**A. LARGE ONE LIGHT
OUTDOOR WALL LANTERN**

W: 12" H: 19.5" E: 14"
Height from center of outlet box
up: 6"

WET

8847901(-71 -12)

(1) Medium Base 100W max.

T24-1

8847901EN3(-71 -12)

(1) Med. Base LED 3000K,
9W, 800 Lumen lamp incl.

T24-2 EN*

8847901DEN3(-71 -12)

(1) Med. Base LED 3000K,
9W, 800 Lumen lamp incl.

T24-2 EN* ☾



A

Antique Bronze Finish (-71)
Creme Parchment Glass



B

Black Finish (-12)
Satin Etched Glass

**B. MEDIUM ONE LIGHT
OUTDOOR WALL LANTERN**

W: 9" H: 15" E: 11"
Height from center of outlet box
up: 5"

WET

8747901(-71 -12)

(1) Medium Base 100W max.

T24-1

8747901EN3(-71 -12)

(1) Med. Base LED 3000K,
9W, 800 Lumen lamp incl.

T24-2 EN*

8747901DEN3(-71 -12)

(1) Med. Base LED 3000K,
9W, 800 Lumen lamp incl.

T24-2 EN* ☾

**C. SMALL ONE LIGHT
OUTDOOR WALL LANTERN**

W: 6" H: 10" E: 7.5"
Height from center of outlet box
up: 3.25"

WET

8547901(-71 -12)

(1) Medium Base 60W max.

T24-1

8547901EN3(-71 -12)

(1) Med. Base LED 3000K,
9W, 800 Lumen lamp incl.

T24-2 EN*

8547901DEN3(-71 -12)

(1) Med. Base LED 3000K,
9W, 800 Lumen lamp incl.

T24-2 EN* ☾



C

Antique Bronze Finish (-71)
Creme Parchment Glass

FINISH CODES

(-71) Antique Bronze
(-12) Black

**D. TWO LIGHT OUTDOOR
CEILING FLUSH MOUNT**

D: 14.125" H: 7"

DAMP

7847902-12

(2) Medium Base 60W max.

T24-1

7847902EN3-12

(2) Med. Base LED 3000K,
9W, 800 Lumen lamps incl.

T24-2 EN*



D

Black Finish (-12)
Satin Etched Glass

**E. ONE LIGHT
OUTDOOR POST LANTERN**

D: 9" H: 17"

WET

8247901(-71 -12)

(1) Medium Base 100W max.

T24-1

8247901EN3(-71 -12)

(1) Med. Base LED 3000K,
9W, 800 Lumen lamp incl.

T24-2 EN*



E

Antique Bronze Finish (-71)
Creame Parchment Glass



Black Finish (-12)
Satin Etched Glass

FINISH CODES

- (-71) Antique Bronze
- (-12) Black

**A. LARGE ONE LIGHT
OUTDOOR WALL LANTERN**

W: 9" H: 21.25" E: 11.75"
Height from center of outlet box
up: 10.25"

WET

8736301(-71 -12)

(1) Medium Base 100W max.

T24-1

736301EN3(-71 -12)

(1) Med. Base LED 3000K,
9W, 800 Lumen lamp incl.

T24-2 EN*



A

Black Finish (-12)
Satin Etched Glass



B

Antique Bronze Finish (-71)
Satin Etched Glass

**B. MEDIUM ONE LIGHT
OUTDOOR WALL LANTERN**

W: 6.375" H: 14.625" E: 8.5"
Height from center of outlet box
up: 7.75"

WET

8636301(-71 -12)

(1) Medium Base 100W max.

T24-1

8636301EN3(-71 -12)

(1) Med. Base LED 3000K,
9W, 800 Lumen lamp incl.

T24-2 EN*

**C. SMALL ONE LIGHT
OUTDOOR WALL LANTERN**

W: 5.5" H: 12.625" E: 7.75"
Height from center of outlet box
up: 7"

WET

8536301(-71 -12)

(1) Medium Base 60W max.

T24-1

8536301EN3(-71 -12)

(1) Med. Base LED 3000K,
9W, 800 Lumen lamp incl.

T24-2 EN*

**D. OUTDOOR ONE LIGHT
POST LANTERN**

D: 9" H: 20.5"

WET

8236301(-71 -12)

(1) Medium Base 75W max.

T24-1

8236301EN3(-71 -12)

(1) Med. Base LED 3000K,
9W, 800 Lumen lamp incl.

T24-2 EN*



C

Black Finish (-12)
Satin Etched Glass



D

Antique Bronze Finish (-71)
Satin Etched Glass

FINISH CODES

(-71) Antique Bronze
(-12) Black

**A. LARGE ONE LIGHT
OUTDOOR WALL LANTERN**

W: 10" H: 19.875" E: 12.75"
Height from center of outlet box
up: 11"

WET

8719301(-71 -12)

(1) Medium Base 75W max.

T24-1

8719301EN3(-71 -12)

(1) Med. Base LED 3000K,
9W, 800 Lumen lamp incl.

T24-2 EN*



A

Black Finish (-12)
Cased Opal Etched Glass



B

Antique Bronze Finish (-71)
Cased Opal Etched Glass

**B. MEDIUM ONE LIGHT
OUTDOOR WALL LANTERN**

W: 8" H: 16.125" E: 10.375"
Height from center of outlet box
up: 9.375"

WET

8619301(-71 -12)

(1) Medium Base 75W max.

T24-1

8619301EN3(-71 -12)

(1) Med. Base LED 3000K,
9W, 800 Lumen lamp incl.

T24-2 EN*

**C. SMALL ONE LIGHT
OUTDOOR WALL LANTERN**

W: 6" H: 11.875" E: 8"
Height from center of outlet box
up: 7.125"

WET

8519301(-71 -12)

(1) Medium Base 60W max.

T24-1

8519301EN3(-71 -12)

(1) Med. Base LED 3000K,
9W, 800 Lumen lamp incl.

T24-2 EN*



C

Black Finish (-12)
Cased Opal Etched Glass

FINISH CODES

(-71) Antique Bronze
(-12) Black

**A. LARGE ONE LIGHT
OUTDOOR WALL LANTERN**

W: 9.25" H: 21" E: 10"
Height from center of outlet box
up: 8.5"

WET ☾

8463D-44

(1) Medium Base 75W max.

T24-1

8463DEN3-44

(1) Med. Base LED 3000K,
9W, 800 Lumen lamp incl.

T24-2 EN*

**B. LARGE ONE LIGHT
OUTDOOR WALL LANTERN**

W: 9.25" H: 21" E: 10"
Height from center of outlet box
up: 8.5"

WET

89273-46

(1) Medium Base 75W max.

T24-1

89273EN3-46

(1) Med. Base LED 3000K,
9W, 800 Lumen lamp incl.

T24-2 EN*



A

Weathered Copper Finish (-44)
Clear Seeded Glass with White Aluminum Backing



B

Oxidized Bronze Finish (-46)
Frosted Seeded Glass

**C. SMALL ONE LIGHT
OUTDOOR WALL LANTERN**

W: 6.75" H: 14.5" E: 7.5"
Height from center of outlet box
up: 6"

WET ☾

8462D-44

(1) Medium Base 75W max.

T24-1

8462DEN3-44

(1) Med. Base LED 3000K,
9W, 800 Lumen lamp incl.

T24-2 EN*



C

Weathered Copper Finish (-44)
Clear Seeded Glass with White Aluminum Backing



D

Oxidized Bronze Finish (-46)
Frosted Seeded Glass

**D. SMALL ONE LIGHT
OUTDOOR WALL LANTERN**

W: 6.75" H: 14.5" E: 7.5"
Height from center of outlet box
up: 6"

WET

89062-46

(1) Medium Base 75W max.

T24-1

89062EN3-46

(1) Med. Base LED 3000K,
9W, 800 Lumen lamp incl.

T24-2 EN*

FINISH CODES

(-44) Weathered Copper
(-46) Oxidized Bronze

**E. LARGE TWO LIGHT
OUTDOOR WALL LANTERN**

W: 9.25" H: 21" E: 10"
Height from center of outlet box
up: 8.5"

WET

8463(-44 -46)

(2) Candelabra Base 40W max.

T24-1

8463EN(-44 -46)

(2) Cand. Base LED 2700K,
3.5W, 350 Lumen lamps incl.

T24-2



E

Weathered Copper Finish (-44)
Clear Seeded Glass

**F. SMALL ONE LIGHT
OUTDOOR WALL LANTERN**

W: 6.75" H: 14.5" E: 7.5"
Height from center of outlet box
up: 6"

WET

8462(-44 -46)

(1) Medium Base 100W max.

T24-1

8462EN7(-44 -46)

(1) Med. Base LED 2700K
8W, 800 Lumen lamps incl.

T24-2



F

Oxidized Bronze Finish (-46)
Clear Seeded Glass



G

Oxidized Bronze Finish (-46)
Clear Seeded Glass

**G. TWO LIGHT
OUTDOOR POST LANTERN**

L: 9.25" W: 9.25" H: 22.75"

WET

8262(-46 -44)

(2) Candelabra Base 60W max.

T24-1

8262EN(-46 -44)

(2) Cand. Base LED 2700K,
3.5W, 350 Lumen lamps incl.

T24-2 EN*

FINISH CODES

- (-44) Weathered Copper
- (-46) Oxidized Bronze

**A. LARGE THREE LIGHT
OUTDOOR WALL LANTERN**

W: 12.25" H: 23.5" E: 14.25"
Height from center of outlet box
up: 11.5"

WET

8461-46

(3) Candelabra Base 40W max.

T24-1

8461EN-46

(3) Cand. Base LED 2700K,
3.5W, 350 Lumen lamps incl.

T24-2 EN*

**B. MEDIUM TWO LIGHT
OUTDOOR WALL LANTERN**

W: 9" H: 18" E: 11.5"
Height from center of outlet box
up: 10.5"

WET

8460-46

(2) Candelabra Base 40W max.

T24-1

8460EN-46

(2) Cand. Base LED 2700K,
3.5W, 350 Lumen lamps incl.

T24-2 EN*



A

Oxidized Bronze Finish (-46)
Clear Seeded Glass



B

Oxidized Bronze Finish (-46)
Clear Seeded Glass



C

Oxidized Bronze Finish (-46)
Clear Seeded Glass

**C. SMALL TWO LIGHT
OUTDOOR WALL LANTERN**

W: 7.5" H: 14.75" E: 9.75"
Height from center of outlet box
up: 8"

WET

8459-46

(2) Candelabra Base 40W max.

T24-1

8459EN-46

(2) Cand. Base LED 2700K,
3.5W, 350 Lumen lamps incl.

T24-2 EN*

**D. THREE LIGHT
OUTDOOR POST LANTERN**

D: 12.25" H: 22.75"

WET

8259-46

(3) Candelabra Base 60W max.

T24-1

8259EN-46

(3) Cand. Base LED 2700K,
3.5W, 350 Lumen lamps incl.

T24-2 EN*



D

Oxidized Bronze Finish (-46)
Clear Seeded Glass

FINISH CODE

(-46) Oxidized Bronze

A. EXTRA LARGE FOUR LIGHT OUTDOOR WALL LANTERN

W: 12" H: 20" E: 13.125"
 Height from center of outlet box up: 6"

WET

OL5904(CB, BK)

(4) Candelabra Base 60W max.

T24-1

OL5904EN/(CB BK)

(4) Cand. Base LED 2700K, 3.5W, 350 Lumen lamps incl.

T24-2 EN*



A

Corinthian Bronze Finish (CB)
 Clear Seeded Glass



B

Black Finish (BK)
 Clear Seeded Glass

B. LARGE THREE LIGHT OUTDOOR WALL LANTERN

W: 10.25" H: 17" E: 11.5"
 Height from center of outlet box up: 6"

WET

OL5902(CB BK)

(3) Candelabra Base 60W max.

T24-1

OL5902EN/(CB BK)

(3) Cand. Base LED 2700K, 3.5W, 350 Lumen lamps incl.

T24-2 EN*



C

Corinthian Bronze Finish (CB)
 Clear Seeded Glass



D

Black Finish (BK)
 Clear Seeded Glass

C. MEDIUM TWO LIGHT OUTDOOR WALL LANTERN

W: 8" H: 14.5" E: 9.5"
 Height from center of outlet box up: 5"

WET

OL5901(CB, BK)

(2) Candelabra Base 60W max.

T24-1

OL5901EN/(CB BK)

(2) Cand. Base LED 2700K, 3.5W, 350 Lumen lamps incl.

T24-2 EN*

D. SMALL ONE LIGHT OUTDOOR WALL LANTERN

W: 6.25" H: 10.75" E: 7.25"
 Height from center of outlet box up: 3.5"

WET

OL5900(CB BK)

(1) Medium Base 75W max.

T24-1

OL5900EN7(CB BK)

1) Med. Base LED 2700K, 8W, 800 Lumen lamps incl.

T24-2 EN*

E. THREE LIGHT OUTDOOR PENDANT

D: 10.25" H: 21"
 Supplied with 7' of Wire and 5' of Chain

DAMP

OL5911(CB BK)

(3) Candelabra Base 60W max.

T24-1

OL5911EN/(CB BK)

(3) Cand. Base LED 2700K, 3.5W, 350 Lumen lamps incl.

T24-2 EN*



E

Corinthian Bronze Finish (CB)
 Clear Seeded Glass



F

Black Finish (BK)
 Clear Seeded Glass

F. THREE LIGHT OUTDOOR POST LANTERN

D: 10.25" H: 22.25"

WET

OL5907(CB BK)

(3) Candelabra Base 60W max.

T24-1

OL5907EN/(CB BK)

(3) Cand. Base LED 2700K, 3.5W, 350 Lumen lamps incl.

T24-2 EN*

FINISH CODES

(CB) Corinthian Bronze
 (BK) Black

**A. EXTRA LARGE ONE LIGHT
OUTDOOR WALL LANTERN**

D: 13" H: 29.75" E: 16"
Height from center of outlet box
up: 11.25"

WET

88243(-780 -12)

(1) Medium Base 75W max.

T24-1

88243EN3(-780 -12)

(1) Med. Base LED 3000K,
9W, 800 Lumen lamp incl.

T24-2 EN*



A

Black Finish (-12)
Etched, White Inside Glass



B

Burled Iron Finish (-780)
Etched, Hammered Glass with Light Amber Tint

**B. LARGE ONE LIGHT
OUTDOOR WALL LANTERN**

D: 11" H: 26.25" E: 13.75"
Height from center of outlet box
up: 9.25"

WET

88242(-780 -12)

(1) Medium Base 75W max.

T24-1

88242EN3(-780 -12)

(1) Med. Base LED 3000K,
9W, 800 Lumen lamp incl.

T24-2 EN*

**C. ONE LIGHT
OUTDOOR POST LANTERN**

D: 11" H: 23"

WET

82240-780

(1) Medium Base 75W max.

T24-1

82240EN3-780

(1) Med. Base LED 3000K,
9W, 800 Lumen lamp incl.

T24-2 EN*



C

Burled Iron Finish (-780)
Etched, Hammered Glass with Light Amber Tint

D. ONE LIGHT OUTDOOR PENDANT

D: 9" H: 15.75"
10' Wire pre-laced through 6' of Chain

DAMP

62240(-780 -12)

(1) Medium Base 75W max.

62240EN3(-780 -12)

(1) Med. Base LED 3000K,
9W, 800 Lumen lamp incl.

T24-2 EN*



D

Black Finish (-12)
Etched, White Inside Glass

FINISH CODES

(-780) Burled Iron
(-12) Black

**E. EXTRA LARGE ONE LIGHT UPLIGHT
OUTDOOR WALL LANTERN**

W: 13" H: 20.25" E: 14"
Height from center of outlet box
up: 4.375"

WET

88244(-780 -12)

(1) Medium Base 75W max.

T24-1

88244EN3(-780 -12)

(1) Med. Base LED 3000K,
9W, 800 Lumen lamp incl.

T24-2 EN*

**F. MEDIUM ONE LIGHT
OUTDOOR WALL LANTERN**

D: 9" H: 15.5" E: 10"
Height from center of outlet box
up: 4.5"

WET

88241(-780)

(1) Medium Base 75W max.

T24-1

88241EN3(-780 -12)

(1) Med. Base LED 3000K,
9W, 800 Lumen lamp incl.

T24-2 EN*

**G. SMALL ONE LIGHT
OUTDOOR WALL LANTERN**

D: 7" H: 10.5" E: 8"
Height from center of outlet box
up: 3"

WET

88240(-780 -12)

(1) Medium Base 75W max.

T24-1

88240EN3(-780 -12)

(1) Med. Base LED 3000K,
9W, 800 Lumen lamp incl.

T24-2 EN*

88240D-780

(1) Medium Base 75W max.

T24-1 ☾

88240DEN3-780

(1) Med. Base LED 3000K,
9W, 800 Lumen lamp incl.

T24-2 EN* ☾



E

Burled Iron Finish (-780)
Etched, Hammered Glass with Light Amber Tint



F

Black Finish (-12)
Etched, White Inside Glass



G

Burled Iron Finish (-780)
Etched, Hammered Glass with Light Amber Tint

FINISH CODES

(-780) Burled Iron
(-12) Black

A. ONE LIGHT MEDIUM OUTDOOR WALL LANTERN

W: 7.75" H: 17" E: 8.5"
Height from center of outlet box up: 14"

WET

89941(-71 -12)

(1) Medium Base 75W max.

T24-1

89941EN3(-71 -12)

(1) Med. Base LED 3000K, 9W, 800 Lumen lamp incl.

T24-2 EN*



A

Bronze Finish (-71)
Satin Etched Glass



B

Bronze Finish (-71)
Clear Beveled Glass

B. ONE LIGHT MEDIUM OUTDOOR WALL LANTERN

W: 7.75" H: 17" E: 8.5"
Height from center of outlet box up: 14"

WET

88941(-71 -12)

(1) Medium Base 75W max.

T24-1

88941EN7(-71 -12)

(1) Med. Base LED 3000K, 9W, 800 Lumen lamp incl.

T24-2 EN*

C. SMALL ONE LIGHT OUTDOOR WALL LANTERN

W: 6.5" H: 11" E: 7.75"
Height from center of outlet box up: 3.3125"

WET

89937(-71 -12)

(1) Medium Base 75W max.

T24-1

89937EN3(-71 -12)

(1) Med. Base LED 3000K, 9W, 800 Lumen lamp incl.

T24-2 EN*



C

Black Finish (-12)
Satin Etched Glass



D

Black Finish (-12)
Clear Beveled Glass

D. SMALL ONE LIGHT OUTDOOR WALL LANTERN

W: 6.5" H: 11" E: 7.75"
Height from center of outlet box up: 3.3125"

WET

88937(-71 -12)

(1) Medium Base 75W max.

T24-1

88937EN7(-71 -12)

(1) Med. Base LED 3000K, 9W, 800 Lumen lamp incl.

T24-2 EN*

FINISH CODES

- (-71) Bronze
- (-12) Black

E. ONE LIGHT MEDIUM OUTDOOR WALL LANTERN

W: 6.5" H: 15.5" E: 7.75"
Height from center of outlet box up: 12.25"

WET

89940(-71 -12)

(1) Medium Base 75W max.

T24-1

89940EN3(-71 -12)

(1) Med. Base LED 3000K, 9W, 800 Lumen lamp incl.

T24-2 EN*



E

Black Finish (-12)
Satin Etched Glass



F

Black Finish (-12)
Clear Beveled Glass

F. ONE LIGHT MEDIUM OUTDOOR WALL LANTERN

W: 6.5" H: 15.5" E: 7.75"
Height from center of outlet box up: 12.25"

WET

88940(-71 -12)

(1) Medium Base 75W max.

T24-1

88940EN7(-71 -12)

(1) Med. Base LED 3000K, 9W, 800 Lumen lamp incl.

T24-2 EN*

G. SMALL ONE LIGHT OUTDOOR WALL LANTERN

W: 6.5" H: 11" E: 7.75"
Height from center of outlet box up: 3.3125"

WET

89936(-71 -12)

(1) Medium Base 75W max.

T24-1

89936EN3(-71 -12)

(1) Med. Base LED 3000K, 9W, 800 Lumen lamp incl.

T24-2 EN*



G

Bronze Finish (-71)
Satin Etched Glass



H

Bronze Finish (-71)
Clear Beveled Glass

H. SMALL ONE LIGHT OUTDOOR WALL LANTERN

W: 6.5" H: 11" E: 7.75"
Height from center of outlet box up: 3.3125"

WET

88936(-71 -12)

(1) Medium Base 75W max.

T24-1

88936EN7(-71 -12)

(1) Med. Base LED 3000K, 9W, 800 Lumen lamp incl.

T24-2 EN*

FINISH CODES

- (-71) Bronze
- (-12) Black

**A. TWO LIGHT OUTDOOR
CEILING FLUSH MOUNT**

D: 12.75" H: 7.5"

DAMP

79136-12

(2) Medium Base 60W max.

T24-1

79136EN3-12

(2) Med. Base LED 3000K,
9W, 800 Lumen lamps incl.

T24-2 EN *

**B. ONE LIGHT OUTDOOR
POST LANTERN**

D: 7.875" H: 17.875"

WET

82941(-71 -12)

(1) Medium Base 75W max.

T24-1

82941EN3(-71 -12)

(1) Med. Base LED 3000K,
9W, 800 Lumen lamp incl.

T24-2 EN *

**C. ONE LIGHT
OUTDOOR PENDANT**

D: 7.875" H: 14.4375"

6' of Wire pre-laced through
3' of Chain

DAMP

60941(-71 -12)

(1) Medium Base 75W max.

T24-1

60941EN3(-71 -12)

(1) Med. Base LED 3000K,
9W, 800 Lumen lamp incl.

T24-2 EN *



A

Black Finish (-12)
Satin Etched Glass



B

Black Finish (-12)
Satin Etched Glass



C

Antique Bronze Finish (-71)
Satin Etched Glass

FINISH CODES

- (-71) Antique Bronze
- (-12) Black

**D. TWO LIGHT OUTDOOR
CEILING FLUSH MOUNT**

D: 12.75" H: 7.5"

DAMP

78136-12

(2) Medium Base 60W max.

T24-1

**E. ONE LIGHT OUTDOOR
POST LANTERN**

D: 7.875" H: 17.875"

WET

82938(-71 -12)

(1) Medium Base 75W max.

T24-1

82938EN7(-71 -12)

(1) Med. Base LED 3000K,
9W, 800 Lumen lamp incl.

T24-2 EN *



D

Black Finish (-12)
Clear Beveled Glass

**F. ONE LIGHT
OUTDOOR PENDANT**

D: 7.875" H: 14.4375"

6' of Wire pre-laced through 3'
of Chain

DAMP

60938(-71 -12)

(1) Medium Base 75W max.

T24-1

60938EN7(-71 -12)

(1) Med. Base LED 3000K,
9W, 800 Lumen lamp incl.

T24-2 EN *



E

Black Finish (-12)
Clear Beveled Glass



F

Antique Bronze Finish (-71)
Clear Beveled Glass

FINISH CODES

(-71) Antique Bronze
(-12) Black

**A. EXTRA LARGE ONE LIGHT DOWNLIGHT
OUTDOOR WALL LANTERN**

W: 12.5" H: 23.25" E: 11.5"
Height from center of outlet box up: 4"

WET

8738751(-71 -12)

(1) Medium Base 75W max.

T24-1

8738751EN3(-71 -12)

(1) Med. Base LED 3000K, 9W, 800 Lumen lamp incl.

T24-2 EN*



A

Antique Bronze Finish (-71)
Satin Etched Glass



B

Black Finish (-12)
Satin Etched Glass

**B. LARGE ONE LIGHT DOWNLIGHT
OUTDOOR WALL LANTERN**

W: 9.375" H: 18.75" E: 8.625"
Height from center of outlet box up: 2.75"

WET

8438751(-71 -12)

(1) Medium Base 75W max.

T24-1

8438751EN3(-71 -12)

(1) Med. Base LED 3000K,
9W, 800 Lumen lamp incl.

T24-2 EN*

**C. MEDIUM ONE LIGHT DOWNLIGHT
OUTDOOR WALL LANTERN**

W: 8.125" H: 15.875" E: 8.5"
Height from center of outlet box up: 3.25"

WET

8938751(-71 -12)

(1) Medium Base 75W max.

T24-1

8938751EN3(-71 -12)

(1) Med. Base LED 3000K,
9W, 800 Lumen lamp incl.

T24-2 EN*

**D. SMALL ONE LIGHT DOWNLIGHT
OUTDOOR WALL LANTERN**

W: 6.5" H: 12.5" E: 7.75"
Height from center of outlet box up: 2.75" down: 9.75"

WET

8338751(-71 -12)

(1) Medium Base 75W max.

T24-1

8338751EN3(-71 -12)

(1) Med. Base LED 3000K,
9W, 800 Lumen lamp incl.

T24-2 EN*



C

Antique Bronze Finish (-71)
Satin Etched Glass



D

Black Finish (-12)
Satin Etched Glass



E

Black Finish (-12)
Satin Etched Glass

E. ONE LIGHT OUTDOOR PENDANT

D: 9.375" H: 16.625"
6' Wire pre-laced through 3' Chain

DAMP

6238751(-71 -12)

(1) Medium Base 75W max.

T24-1

6238751EN3(-71 -12)

(1) Med. Base LED 3000K, 9W, 800 Lumen lamp incl.

T24-2 EN*

FINISH CODES

(-71) Antique Bronze
(-12) Black

**F. LARGE ONE LIGHT UPLIGHT
OUTDOOR WALL LANTERN**

W: 9.375" H: 21.75" E: 8.625"
Height from center of outlet box up: 18.75"

WET

8638751(-71 -12)

(1) Medium Base 75W max.

T24-1

8638751EN3(-71 -12)

(1) Med. Base LED 3000K,
9W, 800 Lumen lamp incl.

T24-2 EN*



F

Antique Bronze Finish (-71)
Satin Etched Glass



G

Black Finish (-12)
Satin Etched Glass



H

Antique Bronze Finish (-71)
Satin Etched Glass

**G. MEDIUM ONE LIGHT UPLIGHT
OUTDOOR WALL LANTERN**

W: 8.125" H: 19.375" E: 8.5"
Height from center of outlet box up: 16.125"

WET

8838751(-71 -12)

(1) Medium Base 75W max.

T24-1

8838751EN3(-71 -12)

(1) Med. Base LED 3000K,
9W, 800 Lumen lamp incl.

T24-2 EN*

**H. SMALL ONE LIGHT UPLIGHT
OUTDOOR WALL LANTERN**

W: 6.5" H: 16.25" E: 7.75"
Height from center of outlet box up: 13.5"
down: 2.75"

WET

8538751(-71 -12)

(1) Medium Base 75W max.

T24-1

8538751EN3(-71 -12)

(1) Med. Base LED 3000K,
9W, 800 Lumen lamp incl.

T24-2 EN*

**I. LARGE ONE LIGHT OUTDOOR
POST LANTERN**

D: 9.375" H: 22.125"

WET

8238751(-71 -12)

(1) Medium Base 75W max.

T24-1

8238751EN3(-71 -12)

(1) Med. Base LED 3000K,
9W, 800 Lumen lamp incl.

T24-2 EN*



I

Antique Bronze Finish (-71)
Satin Etched Glass



J

Antique Bronze Finish (-71)
Satin Etched Glass

**J. MEDIUM ONE LIGHT OUTDOOR
POST LANTERN**

D: 8.125" H: 17.75"

WET

8238651(-71 -12)

(1) Medium Base 75W max.

T24-1

8238651EN3(-71 -12)

(1) Med. Base LED 3000K,
9W, 800 Lumen lamp incl.

T24-2 EN*

FINISH CODES

- (-71) Antique Bronze
- (-12) Black

**A. EXTRA LARGE THREE LIGHT DOWNLIGHT
OUTDOOR WALL LANTERN**

W: 12.5" H: 23.25" E: 11.5"
Height from center of outlet box
up: 4"

WET

8738703(-71 -12)

(3) Candelabra Base 60W max.

T24-1

8738703EN(-71 -12)

(3) Cand. Base LED 2700K,
3.5W, Lumen lamps incl.

T24-2 EN*



A

Antique Bronze Finish (-71)
Clear Glass



B

Black Finish (-12)
Clear Glass

**B. LARGE ONE LIGHT DOWNLIGHT
OUTDOOR WALL LANTERN**

W: 9.375" H: 18.75" E: 8.625"
Height from center of outlet box
up: 2.75"

WET

8438701(-71 -12)

(1) Medium Base 75W max.

T24-1

8438701EN7(-71, -12)

(1) Med. Base LED 3000K,
9W, 800 Lumen lamp incl.

T24-2 EN*

**C. MEDIUM ONE LIGHT DOWNLIGHT
OUTDOOR WALL LANTERN**

W: 8.125" H: 15.875" E: 8.5"
Height from center of outlet box
up: 3.25"

WET

8938701(-71 -12)

(1) Medium Base 75W max.

T24-1

8938701EN7(-71,-12)

(1) Med. Base LED 3000K,
9W, 800 Lumen lamp incl.

T24-2 EN*



C

Antique Bronze Finish (-71)
Clear Glass



D

Black Finish (-12)
Clear Glass

**D. SMALL ONE LIGHT DOWNLIGHT
OUTDOOR WALL LANTERN**

W: 6.5" H: 12.5" E: 7.75"
Height from center of outlet box
up: 2.75"

WET

8338701(-71 -12)

(1) Medium Base 75W max.

T24-1

8338701EN7(-71, 12)

(1) Med. Base LED 3000K,
9W, 800 Lumen lamp incl.

T24-2 EN*

FINISH CODES

(-71) Antique Bronze
(-12) Black

**E. LARGE ONE LIGHT UPLIGHT
OUTDOOR WALL LANTERN**

W: 9.375" H: 21.75" E: 8.625"
Height from center of outlet box up: 18.75"

WET

8638701(-71 -12)

(1) Medium Base 75W max.

T24-1

8638701EN7(-71 -12)

(1) Med. Base LED 3000K, 9W, 800 Lumen lamp incl.

T24-2 EN*

**F. MEDIUM ONE LIGHT UPLIGHT
OUTDOOR WALL LANTERN**

W: 8.125" H: 19.375" E: 8.5"
Height from center of outlet box up: 16.125"

WET

8838701(-71 -12)

(1) Medium Base 75W max.

T24-1

8838701EN7(-71 -12)

(1) Med. Base LED 3000K, 9W, 800 Lumen lamp incl.

T24-2 EN*

**G. SMALL ONE LIGHT UPLIGHT
OUTDOOR WALL LANTERN**

W: 6.5" H: 16.25" E: 7.75"
Height from center of outlet box up: 13.5"

WET

8538701(-71 -12)

(1) Medium Base 75W max.

T24-1

8538701EN7(-71 -12)

(1) Med. Base LED 3000K, 9W, 800 Lumen lamp incl.

T24-2 EN*



E

Antique Bronze Finish (-71)
Clear Glass



F

Black Finish (-12)
Clear Glass



G

Antique Bronze Finish (-71)
Clear Glass

H. LARGE ONE LIGHT OUTDOOR POST LANTERN

D: 9.375" H: 22.125"

WET

8238701-71

(1) Medium Base 75W max.

T24-1

8238701EN7(-71 -12)

(1) Med. Base LED 3000K, 9W, 800 Lumen lamp incl.

T24-2 EN*

I. MEDIUM ONE LIGHT OUTDOOR POST LANTERN

D: 8.125" H: 17.75"

WET

(1) Medium Base 75W max.

T24-1

8238601EN7(-71 -12)

(1) Med. Base LED 3000K, 9W, 800 Lumen lamp incl.

T24-2 EN*

J. ONE LIGHT OUTDOOR PENDANT

D: 9.375" H: 16.625"
6' Wire pre-laced through 3' Chain

DAMP

6238701(-71 -12)

(1) Medium Base 75W max.

T24-1

6238701EN7(-71 -12)

(1) Med. Base LED 3000K, 9W, 800 Lumen lamp incl.

T24-2 EN*



H

Black Finish (-12)
Clear Glass



I

Antique Bronze Finish (-71)
Clear Glass



J

Black Finish (-12)
Clear Glass

FINISH CODES

(-71) Antique Bronze
(-12) Black

**A. EXTRA LARGE ONE LIGHT
OUTDOOR WALL LANTERN**

W: 8.5" H: 19.25" E: 9.5"
Height from center of outlet box
up: 16.5" down: 2.75"

WET +

84532(-746 -12)

(1) Medium Base 75W max.

T24-1

84532EN3(-746 -12)

(1) Med. Base LED 3000K,
9W, 800 Lumen lamp incl.

T24-2 EN*



A

Oxford Bronze Finish (-746)
Satin Etched Glass



B

Oxford Bronze Finish (-746)
Satin Etched Glass

**B. MEDIUM ONE LIGHT
OUTDOOR WALL LANTERN**

W: 6.5" H: 15" E: 8.5"
Height from center of outlet box
up: 12.25" down: 2.75"

WET +

84530(-746 -12)

(1) Medium Base 75W max.

T24-1

84530EN3(-746 -12)

(1) Med. Base LED 3000K,
9W, 800 Lumen lamp incl.

T24-2 EN*

**C. LARGE ONE LIGHT
OUTDOOR WALL LANTERN**

W: 8.5" H: 15" E: 9.5"
Height from center of outlet box
up: 2.75"

WET

84531(-746 -12)

(1) Medium Base 75W max.

T24-1

84531EN3(-746 -12)

(1) Med. Base LED 3000K,
9W, 800 Lumen lamp incl.

T24-2 EN*



C

Black Finish (-12)
Satin Etched Glass



D

Black Finish (-12)
Satin Etched Glass

**D. SMALL ONE LIGHT
OUTDOOR WALL LANTERN**

W: 6.5" H: 11.5" E: 8.5"
Height from center of outlet box
up: 2.75"

WET

84529(-746 -12)

(1) Medium Base 75W max.

T24-1

84529EN3(-746 -12)

(1) Med. Base LED 3000K,
9W, 800 Lumen lamp incl.

T24-2 EN*

FINISH CODES

(-746) Oxford Bronze
(-12) Black

E. ONE LIGHT OUTDOOR PENDANT

L: 8.375" W: 8.375" H: 15.25"
6' of Wire pre-laced through 3' of Chain

DAMP

60531(-746 -12)

(1) Medium Base 75W max.

T24-1

60531EN3(-746 -12)

(1) Med. Base LED 3000K,
9W, 800 Lumen lamp incl.

T24-2 EN*

**F. ONE LIGHT OUTDOOR
POST LANTERN**

L: 8.375" W: 8.375" H: 20.25"

WET

82529(-746 -12)

(1) Medium Base 75W max.

T24-1

82529EN3(-746 -12)

(1) Med. Base LED 3000K,
9W, 800 Lumen lamp incl.

T24-2 EN*



E

Oxford Bronze Finish (-746)
Satin Etched Glass



F

Oxford Bronze Finish (-746)
Satin Etched Glass

FINISH CODES

(-746) Oxford Bronze
(-12) Black

**A. EXTRA LARGE ONE LIGHT
OUTDOOR WALL LANTERN**

W: 8.5" H: 19.25" E: 9.5"
Height from center of outlet box
up: 16.5" down: 2.75"

WET +

84032(-746 -12)

(1) Medium Base 75W max.

T24-1

84032EN7(-746 -12)

(1) Med. Base LED 3000K,
9W, 800 Lumen lamp incl.

T24-2 EN*



A

Oxford Bronze Finish (-746)
Clear Seeded Glass



B

Oxford Bronze Finish (-746)
Clear Seeded Glass

**B. MEDIUM ONE LIGHT
OUTDOOR WALL LANTERN**

W: 6.5" H: 15" E: 8.5"
Height from center of outlet box
up: 12.25" down: 2.75"

WET +

84030(-746 -12)

(1) Medium Base 75W max.

T24-1

84030EN7(-746 -12)

(1) Med. Base LED 3000K,
9W, 800 Lumen lamp incl.

T24-2 EN*

**C. LARGE ONE LIGHT
OUTDOOR WALL LANTERN**

W: 8.5" H: 15" E: 9.5"
Height from center of outlet box
up: 2.75"

WET

84031(-746 -12)

(1) Medium Base 75W max.

T24-1

84031EN7(-746 -12)

(1) Med. Base LED 3000K,
9W, 800 Lumen lamp incl.

T24-2 EN*



C

Black Finish (-12)
Clear Beveled Glass



D

Black Finish (-12)
Clear Beveled Glass

**D. SMALL ONE LIGHT
OUTDOOR WALL LANTERN**

W: 6.5" H: 11.5" E: 8.5"
Height from center of outlet box
up: 2.75"

WET

84029EN7(-746 -12)

(1) Medium Base 75W max.

T24-1

FINISH CODES

(-746) Oxford Bronze with Clear Seeded Glass
(-12) Black with Clear Beveled Glass

E. ONE LIGHT OUTDOOR PENDANT

L: 8.375" W: 8.375" H: 15.25"
6' of Wire pre-laced through 3' of Chain

DAMP

60031(-746 -12)

(1) Medium Base 75W max.

T24-1

60031EN7(-746 -12)

(1) Med. Base LED 3000K,
9W, 800 Lumen lamp incl.

T24-2 EN*

F. ONE LIGHT OUTDOOR SEMI-FLUSH CONVERTIBLE PENDANT

L: 6.5" W: 6.5" H: 10.5" Semi-flush H: 9.75"
10' Wire pre-laced through 4' Chain

DAMP +

60029(-746 -12)

(1) Medium Base 75W max.

T24-1

60029EN7(-746 -12)

(1) Med. Base LED 3000K,
9W, 800 Lumen lamp incl.

T24-2 EN*

G. ONE LIGHT OUTDOOR POST LANTERN

L: 8.375" W: 8.375" H: 20.25"

WET

82029(-746 -12)

(1) Medium Base 75W max.

T24-1

82029EN7(-746 -12)

(1) Med. Base LED 3000K,
9W, 800 Lumen lamp incl.

T24-2 EN*



E

Oxford Bronze Finish (-746)
Clear Seeded Glass



F

Semi-Flush in Black Finish (-12)
Clear Beveled Glass



G

Oxford Bronze Finish (-746)
Clear Seeded Glass

FINISH CODES

(-746) Oxford Bronze with Clear Seeded Glass
(-12) Black with Clear Beveled Glass

A. MEDIUM ONE LIGHT OUTDOOR WALL LANTERN

W: 7.25" H: 11.75" E: 9.5"
 Height from center of outlet box
 up: 3.25"

WET

89132-12

(1) Medium Base 75W max.

T24-1

89132EN3-12

(1) Med. Base LED 3000K,
 9W, 800 Lumen lamp incl.

T24-2 EN *



A

Black Finish (-12)
 Etched, White Inside Glass



B

Black Finish (-12)
 Etched, White Inside Glass

B. SMALL ONE LIGHT OUTDOOR WALL LANTERN

W: 6" H: 10" E: 9"
 Height from center of outlet box
 up: 3.25"

WET

89131-12

(1) Medium Base 75W max.

T24-1

89131EN3-12

(1) Med. Base LED 3000K,
 9W, 800 Lumen lamp incl.

T24-2 EN *

C. TWO LIGHT OUTDOOR CEILING FLUSH MOUNT

L: 10.75" W: 10.75" H: 6.5"

DAMP

79131-12

(2) Medium Base 60W max.

T24-1

79131EN3-12

(2) Med. Base LED 3000K,
 9W, 800 Lumen lamps incl.

T24-2 EN *



C

Black Finish (-12)
 Etched, White Inside Glass

D. ONE LIGHT OUTDOOR PENDANT

L: 7.25" W: 7.25" H: 11.25"

WET

69131-12

(1) Medium Base 75W max.

T24-1

69131EN3-12

(1) Med. Base LED 3000K,
 9W, 800 Lumen lamp incl.

T24-2 EN *



D

Black Finish (-12)
 Etched, White Inside Glass

E. ONE LIGHT OUTDOOR POST LANTERN

L: 7.25" W: 7.25" H: 16.5"

WET

89231-12

(1) Medium Base 75W max.

T24-1

89231EN3-12

(1) Med. Base LED 3000K,
 9W, 800 Lumen lamp incl.

T24-2 EN *



E

Black Finish (-12)
 Etched, White Inside Glass

FINISH CODE

(-12) Black

**F. MEDIUM ONE LIGHT
OUTDOOR WALL LANTERN**

W: 7.25" H: 11.75" E: 9.5"
Height from center of outlet box
up: 3.25"

WET

88132-12

(1) Medium Base 75W max.

T24-1

88132EN7-12

(1) Med. Base LED 3000K,
9W, 800 Lumen lamp incl.

T24-2 EN*



F

Black Finish (-12)
Clear Seeded Glass



G

Black Finish (-12)
Clear Seeded Glass

**G. SMALL ONE LIGHT
OUTDOOR WALL LANTERN**

W: 6" H: 10" E: 9"
Height from center of outlet box
up: 3.25"

WET

88131-12

(1) Medium Base 75W max.

T24-1

88131EN7-12

(1) Med. Base LED 3000K,
9W, 800 Lumen lamp incl.

T24-2 EN*

**H. TWO LIGHT OUTDOOR
CEILING FLUSH MOUNT**

L: 10.75" W: 10.75" H: 6.5"

DAMP

78131-12

(2) Medium Base 60W max.

T24-1

78131EN7-12

(1) Med. Base LED 3000K,
9W, 800 Lumen lamp incl.

T24-2 EN*



H

Black Finish (-12)
Clear Seeded Glass

I. ONE LIGHT OUTDOOR PENDANT

L: 7.25" W: 7.25" H: 11.25"
10' Wire pre-laced through 6' Chain

DAMP

60131-12

(1) Medium Base 75W max.

T24-1

60131EN7-12

(1) Med. Base LED 3000K,
9W, 800 Lumen lamp incl.

T24-2 EN*



I

Black Finish (-12)
Clear Seeded Glass

**J. ONE LIGHT OUTDOOR
POST LANTERN**

L: 7.25" W: 7.25" H: 16.5"

WET

82131-12

(1) Medium Base 75W max.

T24-1

82131EN7-12

(1) Med. Base LED 3000K,
9W, 800 Lumen lamp incl.

T24-2 EN*



J

Black Finish (-12)
Clear Seeded Glass

FINISH CODE

(-12) Black

A. EXTRA LARGE ONE LIGHT OUTDOOR WALL LANTERN

W: 7" H: 20.25" W: 7.75"
 Height from center of outlet box up: 6.5"

WET

84670-71

(1) Medium Base 75W max.

T24-1

84670EN3-71

(1) Med. Base LED 3000K,
 9W, 800 Lumen lamp incl.

T24-2 EN *



A

Antique Bronze Finish (-71)
 Frosted Seeded Glass



B

Antique Bronze Finish (-71)
 Frosted Seeded Glass

B. LARGE ONE LIGHT OUTDOOR WALL LANTERN

W: 7" H: 17" E: 8"
 Height from center of outlet box up: 6.5"

WET

84580-71

(1) Medium Base 75W max.

T24-1

84580EN3-71

(1) Med. Base LED 3000K,
 9W, 800 Lumen lamp incl.

T24-2 EN *

C. MEDIUM ONE LIGHT OUTDOOR WALL LANTERN

W: 5.25" H: 12.5" E: 5.75"
 Height from center of outlet box up: 6"

WET

84570-71

(1) Medium Base 75W max.

T24-1

84570EN3-71

(1) Med. Base LED 3000K,
 9W, 800 Lumen lamp incl.

T24-2 EN *



C

Antique Bronze Finish (-71)
 Frosted Seeded Glass

D. SMALL ONE LIGHT OUTDOOR WALL LANTERN

W: 4" H: 11.25" E: 5.75"
 Height from center of outlet box up: 6"

WET

84560-71

(1) Medium Base 75W max.

T24-1

84560EN3-71

(1) Med. Base LED 3000K,
 9W, 800 Lumen lamp incl.

T24-2 EN *



E

Antique Bronze Finish (-71)
 Frosted Seeded Glass

E. ONE LIGHT OUTDOOR POST LANTERN

L: 7" W: 7" H: 17.25"

WET

82570-71

(1) Medium Base 75W max.

T24-1

82570EN3-71

(1) Med. Base LED 3000K,
 9W, 800 Lumen lamp incl.

T24-2 EN *



D

Antique Bronze Finish (-71)
 Frosted Seeded Glass

FINISH CODE

(-71) Antique Bronze

F. EXTRA LARGE TWO LIGHT OUTDOOR WALL LANTERN

W: 7" H: 20.25" E: 7.75"
 Height from center of outlet box up: 6.5"

WET

8468(-965 -71 -12)
 (2) Candelabra Base 40W max.

T24-1

8468EN(-965 -71 -12)
 (2) Cand. Base LED 2700K, 3.5W, 350 Lumen lamps incl.

T24-2 EN*



F

Antique Brushed Nickel Finish (-965)
 Clear Beveled Glass



G

Antique Bronze Finish (-71)
 Clear Beveled Glass



J

Antique Bronze Finish (-71)
 Clear Beveled Glass

G. LARGE ONE LIGHT OUTDOOR WALL LANTERN

W: 7" H: 17" E: 8"
 Height from center of outlet box up: 6.5"

WET

8458(-965 -71 -12)
 (1) Medium Base 75W max.

T24-1

8458EN7-965-71-12
 (1) Med. Base LED 3000K, 9W, 800 Lumen lamp incl.

T24-2 EN*

H. MEDIUM ONE LIGHT OUTDOOR WALL LANTERN

W: 5.25" H: 12.5" E: 5.75"
 Height from center of outlet box up: 6"

WET

8457(-965 -71 -12)
 (1) Medium Base 75W max.

T24-1

8457EN7-965-71-12
 (1) Med. Base LED 3000K, 9W, 800 Lumen lamp incl.

T24-2 EN*



H

Black Finish (-12)
 Clear Beveled Glass



I

Antique Brushed Nickel Finish (-965)
 Clear Beveled Glass

I. SMALL ONE LIGHT OUTDOOR WALL LANTERN

W: 4" H: 11.25" E: 5.75"
 Height from center of outlet box up: 6"

WET

8456(-965 -71 -12)
 (1) Medium Base 75W max.

T24-1

8456EN7-965-71-12
 (1) Med. Base LED 3000K, 9W, 800 Lumen lamp incl.

T24-2 EN*

J. ONE LIGHT OUTDOOR POST LANTERN

L: 7" W: 7" H: 17.25"

WET

8257(-965 -71 -12)
 (1) Medium Base 75W max.

T24-1

8257EN7(-965 -71 -12)
 (1) Med. Base LED 3000K, 9W, 800 Lumen lamp incl.

T24-2 EN*

K. LARGE ONE LIGHT OUTDOOR WALL LANTERN

W: 7" H: 17" E: 8"
 Height from center of outlet box up: 6.5"

WET ☾

84158D(-71 -12)
 (1) Medium Base 75W max.

T24-1

84158DEN3(-71 -12)
 (1) Med. Base LED 3000K, 9W, 800 Lumen lamp incl.

T24-2 EN*



K

Black Finish (-12)
 Etched White Tiffany Glass



L

Antique Bronze Finish (-71)
 Etched White Tiffany Glass

L. MEDIUM ONE LIGHT OUTDOOR WALL LANTERN

W: 5.25" H: 12.5" E: 5.75"
 Height from center of outlet box up: 6"

WET ☾

84157D-71
 (1) Medium Base 75W max.

T24-1

84157DEN3-71
 (1) Med. Base LED 3000K, 9W, 800 Lumen lamp incl.

T24-2 EN*

FINISH CODES

- (-965) Antique Brushed Nickel
- (-71) Antique Bronze
- (-12) Black

**A. EXTRA LARGE THREE LIGHT
OUTDOOR WALL LANTERN**

W: 11.75" H: 23" E: 11"
Height from center of outlet box up: 10"

WET

8040(-02 -965 -71 -12)

(3) Candelabra Base 40W max.

T24-1

8040EN(-02 -965 -71 -12)

(3) Cand. Base LED 2700K,
3.5W, 350 Lumen lamps incl.

T24-2 EN*



A

Black Finish (-12)
Clear Curved Beveled Glass



B

Antique Brushed Nickel Finish (-965)
Clear Curved Beveled Glass

**B. LARGE TWO LIGHT
OUTDOOR WALL LANTERN**

W: 10" H: 20.5" E: 9.5"
Height from center of outlet box up: 9.5"

WET

8039(-02 -965 -71 -12)

(2) Candelabra Base 40W max.

T24-1

8039EN(-02 -965 -71 -12)

(2) Cand. Base LED 2700K,
3.5W, 350 Lumen lamps incl.

T24-2 EN*

**C. MEDIUM ONE LIGHT
OUTDOOR WALL LANTERN**

W: 7.75" H: 14" E: 7.5"
Height from center of outlet box up: 6.5"

WET

8067(-02 -965 -71 -12)

(1) Medium Base 75W max.

T24-1

8067EN7(-02 -965 -71 -12)

(1) Med. Base LED 3000K,
9W, 800 Lumen lamp incl.

T24-2 EN*

**D. MEDIUM ONE LIGHT
OUTDOOR WALL LANTERN**

W: 7.75" H: 12" E: 7.5"
Height from center of outlet box up: 4.5"

WET

8038(-02 -965 -71 -12)

(1) Medium Base 75W max.

T24-1

8038EN7(02 -965 -71 -12)

(1) Med. Base LED 3000K,
9W, 800 Lumen lamp incl.

T24-2 EN*



C

Polished Brass Finish (-02)
Clear Curved Beveled Glass



D

Black Finish (-12)
Clear Curved Beveled Glass



E

Polished Brass Finish (-02)
Clear Curved Beveled Glass

**E. SMALL ONE LIGHT
OUTDOOR WALL LANTERN**

W: 7" H: 12" E: 7"
Height from center of outlet box up: 5.75"

WET

8037(-02 -965 -71 -12)

(1) Medium Base 75W max.

T24-1

8037EN7(-02 -965 -71 -12)

(1) Med. Base LED 3000K,
9W, 800 Lumen lamp incl.

T24-2 EN*

FINISH CODES

- (-02) Polished Brass
- (-965) Antique Brushed Nickel
- (-71) Antique Bronze
- (-12) Black

**F. LARGE THREE LIGHT
OUTDOOR POST LANTERN**

D: 11.75" H: 24"

WET

8239(-02 -965 -71 -12)

(3) Candelabra Base 60W max.

T24-1

8239EN(-02 -965 -71 -12)

(3) Cand. Base LED 2700K,
3.5W, 350 Lumen lamps incl.

T24-2 EN*



F

Polished Brass Finish (-02)
Clear Curved Beveled Glass



G

Antique Bronze Finish (-71)
Clear Curved Beveled Glass

**G. MEDIUM TWO LIGHT
OUTDOOR POST LANTERN**

D: 10" H: 21.5"

WET

8229(-965 -71 -12)

(2) Candelabra Base 60W max.

T24-1

8229EN(-965 -71 -12)

(2) Cand. Base LED 2700K,
3.5W, 350 Lumen lamps incl.

T24-2 EN*

**H. LARGE THREE LIGHT
OUTDOOR PENDANT**

D: 11.75" H: 20.75"

10' Wire pre-laced through 4' Chain

DAMP

6039(-02 -965 -71 -12)

(3) Candelabra Base 40W max.

T24-1

6039EN(-02 -965 -71 -12)

(3) Cand. Base LED 2700K,
3.5W, 350 Lumen lamps incl.

T24-2 EN*



H

Antique Brushed Nickel Finish (-965)
Clear Curved Beveled Glass

FINISH CODES

- (-02) Polished Brass
- (-965) Antique Brushed Nickel
- (-71) Antique Bronze
- (-12) Black

**A. LARGE ONE LIGHT
OUTDOOR WALL LANTERN**

W: 7" H: 25.5" H Without Tail: 17.75" E: 7"
Height from center of outlet box up: 15"

WET +

8510(-02 -12)

(1) Medium Base 75W max.

T24-1

8510EN7(-02 -12)

(1) Med. Base LED 3000K,
9W, 800 Lumen lamp incl.

T24-2 EN *

**B. MEDIUM ONE LIGHT
OUTDOOR WALL LANTERN**

W: 7" H: 12.25" E: 7.25"

Height from center of outlet box up: 3.25"

WET

8509(-02 -12)

(1) Medium Base 75W max.

T24-1

8509EN7(02 -12)

(1) Med. Base LED 3000K,
9W, 800 Lumen lamp incl.

T24-2 EN *

**C. SMALL ONE LIGHT
OUTDOOR WALL LANTERN**

W: 5.75" H: 10.5" E: 5.75"

Height from center of outlet box up: 7.25"

WET

8507(-02 -12)

(1) Medium Base 75W max.

T24-1

8507EN7(-02 -12)

(1) Med. Base LED 3000K,
9W, 800 Lumen lamp incl.

T24-2 EN *



A

Polished Brass Finish (-02)
Clear Beveled Glass



B

Black Finish (-12)
Clear Beveled Glass



C

Polished Brass Finish (-02)
Clear Beveled Glass

FINISH CODES

(-02) Polished Brass
(-12) Black

D. ONE LIGHT OUTDOOR SEMI-FLUSH CONVERTIBLE PENDANT

D: 7" H: 12.5" Semi Flush H: 13"
10' Wire pre-laced through 4' Chain

DAMP +

6008(-02 -12)

(1) Medium Base 75W max.

T24-1

6008EN7(-02 -12)

(1) Med. Base LED 3000K, 9W, 800 Lumen lamp incl.

T24-2 EN *

E. ONE LIGHT OUTDOOR POST LANTERN

D: 7" H: 15.75"

WET

8209-(-02 -12)

(1) Medium Base 75W max.

T24-1

8209EN7(-02 -12)

(1) Med. Base LED 3000K, 9W, 800 Lumen lamp incl.

T24-2 EN *



D

Polished Brass Finish (-02)
Clear Beveled Glass

Black Finish (-12)
Clear Beveled Glass

E

Polished Brass Finish (-02)
Clear Beveled Glass

FINISH CODES

- (-02) Polished Brass
- (-12) Black

**A. MEDIUM ONE LIGHT UPLIGHT
OUTDOOR WALL LANTERN**

W: 10.25" H: 19.75" E: 10.75"
Height from center of outlet box
up: 15"

WET

89824-12

(1) Medium Base 75W max.

T24-1

89824EN3-12

(1) Med. Base LED 3000K,
9W, 800 Lumen lamp incl.

T24-2 EN *

**B. MEDIUM ONE LIGHT DOWNLIGHT
OUTDOOR WALL LANTERN**

W: 10.25" H: 18" E: 10.75"
Height from center of outlet box
up: 4.75"

WET

89825-12

(1) Medium Base 75W max.

T24-1

89825EN3-12

(1) Med. Base LED 3000K,
9W, 800 Lumen lamp incl.

T24-2 EN *

**C. SMALL ONE LIGHT
OUTDOOR WALL LANTERN**

W: 7" H: 10.25" E: 7"
Height from center of outlet box
up: 6"

WET

89822-12

(1) Medium Base 60W max.

T24-1

89822EN3-12

(1) Med. Base LED 3000K,
9W, 800 Lumen lamp incl.

T24-2 EN *



A

Black Finish (-12)
Etched, White Inside Glass



B

Black Finish (-12)
Etched, White Inside Glass



C

Black Finish (-12)
Etched, White Inside Glass

FINISH CODES

(-12) Black

**D. TWO LIGHT OUTDOOR
CEILING FLUSH MOUNT**

D: 12.75" H: 7.5"

DAMP

79136-12

(2) Medium Base 60W max.

T24-1

79136EN3-12

(2) Med. Base LED 3000K,
9W, 800 Lumen lamps incl.

T24-2 EN*



D

Black Finish (-12)
Etched, White Inside Glass

**E. ONE LIGHT
OUTDOOR POST LANTERN**

D: 13" H: 25.75"

WET

89025-12

(1) Medium Base 75W max.

T24-1

89025EN3-12

(1) Med. Base LED 3000K,
9W, 800 Lumen lamp incl.

T24-2 EN*



E

Black Finish (-12)
Etched, White Inside Glass

**F. ONE LIGHT
OUTDOOR PENDANT**

D: 10.25" H: 18.75"

10' Wire pre-laced through 3' Chain

DAMP

69025-12

(1) Medium Base 75W max.

T24-1

69025EN3-12

(1) Med. Base LED 3000K,
9W, 800 Lumen lamp incl.

T24-2 EN*



F

Black Finish (-12)
Etched, White Inside Glass

FINISH CODES

(-12) Black

**A. MEDIUM ONE LIGHT UPLIGHT
OUTDOOR WALL LANTERN**

W: 10.25" H: 19.75" E: 10.75"
Height from center of outlet box up: 15"

WET

8824-12

(1) Medium Base 75W max.

T24-1

8824EN7-12

(1) Med. Base LED 3000K,
9W, 800 Lumen lamp incl.

T24-2 EN *

**B. MEDIUM ONE LIGHT DOWNLIGHT
OUTDOOR WALL LANTERN**

W: 10.25" H: 18" E: 10.75"
Height from center of outlet box up: 4.75"

WET

8825-12

(1) Medium Base 75W max.

T24-1

8825EN7-12

(1) Med. Base LED 3000K,
9W, 800 Lumen lamp incl.

T24-2 EN *

**C. SMALL ONE LIGHT OUTDOOR
WALL LANTERN**

W: 7" H: 10.25" E: 7"
Height from center of outlet box up: 6"

WET

8822-12

(1) Medium Base 60W max.

T24-1

8822EN7-12

(1) Med. Base LED 3000K,
9W, 800 Lumen lamp incl.

T24-2 EN *



A

Black Finish (-12)
Clear Beveled Glass



B

Black Finish (-12)
Clear Beveled Glass



C

Black Finish (-12)
Clear Beveled Glass

FINISH CODES

(-12) Black

**D. TWO LIGHT OUTDOOR
CEILING FLUSH MOUNT**

D: 12.75" H: 7.5"

DAMP

78136-12

(2) Medium Base 60W max.

T24-1

**E. THREE LIGHT OUTDOOR
POST LANTERN**

D: 13" H: 25.75"

WET

8231-12

(3) Candelabra Base 60W max.

T24-1

8231EN-12

(3) Cand. Base LED 2700K,
3.5W, 350 Lumen lamps incl.

T24-2 EN*



D

Black Finish (-12)
Clear Beveled Glass

**F. ONE LIGHT OUTDOOR
PENDANT**

D: 10.25" H: 18.75"

10' Wire pre-laced through 3' Chain

DAMP

6025-12

(1) Medium Base 75W max.

T24-1

6025EN7-12

(1) Med. Base LED 3000K,
9W, 800 Lumen lamp incl.

T24-2 EN*



E

Black Finish (-12)
Clear Beveled Glass



F

Black Finish (-12)
Clear Beveled Glass

FINISH CODES

(-12) Black



PRODUCT SHOWN: COTSWOLD LANE LARGE
OUTDOOR WALL LANTERN IN BLACK FINISH

A. EXTRA LARGE LANTERN

W: 13.625" H: 36.25" E: 17.875"
 Height from center of outlet box up: 12"
 WET

OL5405(BK GBZ)
 (4) Candelabra Base 60W max

B. LARGE LANTERN

W: 12" H: 30" E: 16.25"
 Height from center of outlet box up: 12.875"
 WET

OL5404(BK GBZ)
 (3) Candelabra Base 60W max

C. MEDIUM LANTERN

W: 9.5" H: 23.75" E: 13.625"
 Height from center of outlet box up: 10.5"
 WET

OL5402(BK GBZ)
 (3) Candelabra Base 60W max

D. SMALL LANTERN

W: 9" H: 20" E: 11.625"
 Height from center of outlet box up: 8.5"
 WET

OL5401(BK GBZ)
 (2) Candelabra Base 60W max

E. EXTRA SMALL LANTERN

W: 6.5" H: 11.5" E: 7.75"
 Height from center of outlet box up: 3.5"
 WET

OL5400(BK GBZ)
 (1) Medium 75W max

F. POCKET LANTERN

W: 9.5" H: 16" E: 6"
 Height from center of outlet box up: 9.625"
 WET

OL5403(BK GBZ)
 (2) Candelabra Base 60W max



A

Black Finish (BK)
 Clear Beveled Glass



B

Grecian Bronze Finish (GBZ)
 Clear Beveled Glass



C

Grecian Bronze Finish (GBZ)
 Clear Beveled Glass



D

Black Finish (BK)
 Clear Beveled Glass



E

Grecian Bronze Finish (GBZ)
 Clear Beveled Glass



F

Black Finish (BK)
 Clear Beveled Glass

FINISH CODES

(BK) Black
 (GBZ) Grecian Bronze

A. LARGE PENDANT

L: 13.625" W:13.625" H: 31"
15' Wire, 5' Chain

DAMP

OL5414(BK GBZ)

(4) Candelabra Base 60W max

B. MEDIUM PENDANT

L: 12" W:12" H: 26.5"
1' Wire

DAMP

OL5412(BK GBZ)

(3) Candelabra Base 60W max

C. SMALL PENDANT

L: 9.5" W:9.5" H: 21.5"
1' Wire

DAMP

OL5411(BK GBZ)

(3) Candelabra Base 60W max



A

Black Finish (BK)
Clear Beveled Glass



B

Black Finish (BK)
Clear Beveled Glass



C

Grecian Bronze Finish (GBZ)
Clear Beveled Glass

FINISH CODES

(BK) Black
(GBZ) Grecian Bronze

D. FLUSH MOUNT

L: 11.5" W:11.5" H: 6.625"

DAMP

OL5413(BK GBZ)

(2) Medium Base 60W max

E. LARGE POST

W: 12" H: 27.5"

WET

OL5408(BK GBZ)

(3) Candelabra Base 60W max

F. SMALL POST

W: 9.5" H: 22.5"

WET

OL5407(BK GBZ)

(3) Candelabra Base 60W max



D

Black Finish (BK)
Clear Beveled Glass



E

Black Finish (BK)
Clear Beveled Glass



F

Grecian Bronze Finish (GBZ)
Clear Beveled Glass

FINISH CODES

(BK) Black

(GBZ) Grecian Bronze

A. LARGE LANTERN

W: 12" H: 30" E: 16.25"
Height from center of outlet box up: 12.875"
WET

OL5424BK
(3) Candelabra Base 60W max

B. MEDIUM LANTERN

W: 9.5" H: 23.75" E: 13.625"
Height from center of outlet box up: 10.5"
WET

OL5422BK
(3) Candelabra Base 60W max

C. SMALL LANTERN

W: 9" H: 20" E: 11.625"
Height from center of outlet box up: 8.5"
WET

OL5421BK
(2) Candelabra Base 60W max

D. POCKET LANTERN

W: 9.5" H: 16" E: 6"
Height from center of outlet box up: 9.625"
WET

OL5423BK
(2) Candelabra Base 60W max

E. EXTRA SMALL LANTERN

W: 6.5" H: 11.5" E: 7.75"
Height from center of outlet box up: 3.5"
WET

OL5420BK
(1) Medium 75W max



A
Black Finish (BK)
Clear Seeded Glass

B
Black Finish (BK)
Clear Seeded Glass

C
Black Finish (BK)
Clear Seeded Glass



D
Black Finish (BK)
Clear Seeded Glass

E
Black Finish (BK)
Clear Seeded Glass

FINISH CODES

(BK) Black
(GBZ) Grecian Bronze

F. MEDIUM PENDANT

L: 12" W:12" H: 26.5"

15' Wire

DAMP

OL5432BK

(3) Candelabra Base 60W max



F

Black Finish (BK)
Clear Seeded Glass



G

Black Finish (BK)
Clear Seeded Glass

G. SMALL PENDANT

L: 9.5" W:9.5" H: 21.5"

15' Wire

DAMP

OL5431BK

(3) Candelabra Base 60W max

H. FLUSH MOUNT

L: 11.5" W:11.5" H: 6.625"

DAMP

OL5433BK

(2) Medium Base 60W max



H

Black Finish (BK)
Clear Seeded Glass

I. LARGE POST

W: 12" H: 27.5"

WET

OL5428BK

(3) Candelabra Base 60W max



I

Black Finish (BK)
Clear Seeded Glass



J

Black Finish (BK)
Clear Seeded Glass



Grecian Bronze Finish (GBZ)
Clear Seeded Glass

J. SMALL POST

W: 9.5" H: 22.5"

WET

OL5427BK(BK GBZ)

(3) Candelabra Base 60W max

FINISH CODES

(BK) Black

(GBZ) Grecian Bronze

A. LARGE ONE LIGHT OUTDOOR WALL LANTERN

W: 7.75" H: 23.5" E: 10.75"
 Height from center of outlet box up: 16"

WET

89103-12

(1) Medium Base 75W max.

T24-1

89103EN3-12

(1) Med. Base LED 3000K, 9W, 800 Lumen lamp incl.

T24-2 EN*



A

Black Powdercoat Finish (-12)
 Frosted Glass



B

Black Powdercoat Finish (-12)
 Frosted Glass

B. MEDIUM ONE LIGHT OUTDOOR WALL LANTERN

W: 6.25" H: 19.75" E: 10"
 Height from center of outlet box up: 15.25"

WET

89102-12

(1) Medium Base 75W max.

T24-1

89102EN3-12

(1) Med. Base LED 3000K, 9W, 800 Lumen lamp incl.

T24-2 EN*

C. SMALL ONE LIGHT OUTDOOR WALL LANTERN

W: 6" H: 9.75" E: 6.75"
 Height from center of outlet box up: 2.5"

WET

89101-12

(1) Medium Base 75W max.

T24-1

89101EN3-12

(1) Med. Base LED 3000K, 9W, 800 Lumen lamp incl.

T24-2 EN*



C

Black Powdercoat Finish (-12)
 Frosted Glass



D

Black Powdercoat Finish (-12)
 Frosted Glass



E

Black Powdercoat Finish (-12)
 Frosted Glass

D. EXTRA SMALL ONE LIGHT OUTDOOR WALL LANTERN

W: 5" H: 11.25" E: 8"
 Height from center of outlet box up: 4.3125"

WET

89104-12

(1) Medium Base 75W max.

T24-1

89104EN3-12

(1) Med. Base LED 3000K, 9W, 800 Lumen lamp incl.

T24-2 EN*

E. TWO LIGHT OUTDOOR CEILING FLUSH MOUNT

D: 12.75" H: 7.5"

DAMP

79136-12

(2) Medium Base 60W max.

T24-1

79136EN3-12

(2) Med. Base LED 3000K, 9W, 800 Lumen lamps incl.

T24-2 EN*

F. SMALL ONE LIGHT OUTDOOR POST LANTERN

D: 6.125" H: 18.5"

WET

89202-12

(1) Medium Base 75W max.

T24-1

89202EN3-12

(1) Med. Base LED 3000K, 9W, 800 Lumen lamp incl.

T24-2 EN*



F

Black Powdercoat Finish (-12)
 Frosted Glass

FINISH CODE

(-12) Black

G. LARGE TWO LIGHT OUTDOOR WALL LANTERN

W: 7.75" H: 23.5" E: 10.75"
 Height from center of outlet box up: 16"

WET

88201-12

(2) Candelabra Base 60W max.

T24-1

88201EN-12

(2) Cand. Base LED 2700K, 3.5W, 350 Lumen lamps incl.

T24-2 EN*



G

Black Powdercoat Finish (-12)
 Clear Beveled Glass



H

Black Powdercoat Finish (-12)
 Clear Beveled Glass

H. MEDIUM ONE LIGHT OUTDOOR WALL LANTERN

W: 6.25" H: 19.75" E: 10"
 Height from center of outlet box up: 15.25"

WET

88200-12

(1) Medium Base 75W max.

T24-1

88200EN7-12

(1) Med. Base LED 3000K, 9W, 800 Lumen lamp incl.

T24-2 EN*

I. SMALL ONE LIGHT OUTDOOR WALL LANTERN

W: 6" H: 9.75" E: 6.75"
 Height from center of outlet box up: 2.5"

WET

85200-12

(1) Medium Base 75W max.

T24-1

85200EN7-12

(1) Med. Base LED 3000K, 9W, 800 Lumen lamp incl.

T24-2 EN*



I

Black Powdercoat Finish (-12)
 Clear Beveled Glass



J

Black Powdercoat Finish (-12)
 Clear Beveled Glass



K

Black Powdercoat Finish (-12)
 Clear Beveled Glass

J. EXTRA SMALL ONE LIGHT OUTDOOR WALL LANTERN

W: 5" H: 11.25" E: 8"
 Height from center of outlet box up: 4.3125"

WET

88203-12

(1) Medium Base 75W max.

T24-1

88203EN7-12

(1) Med. Base LED 3000K, 9W, 800 Lumen lamp incl.

T24-2 EN*

K. TWO LIGHT OUTDOOR CEILING FLUSH MOUNT

D: 12.75" H: 7.5"

DAMP

78136-12

(2) Medium Base 60W max.

T24-1

78136EN7-12

(1) Med. Base LED 3000K, 9W, 800 Lumen lamp incl.

T24-2 EN*

L. MEDIUM TWO LIGHT OUTDOOR POST LANTERN

D: 7.75" H: 23"

WET

82200-12

(2) Candelabra Base 60W max.

T24-1

82200EN-12

(2) Cand. Base LED 2700K, 3.5W, 350 Lumen lamps incl.

T24-2 EN*



L

Black Powdercoat Finish (-12)
 Clear Beveled Glass



M

Black Powdercoat Finish (-12)
 Clear Beveled Glass

M. SMALL ONE LIGHT OUTDOOR POST LANTERN

D: 6.125" H: 18.5"

WET

82202-12

(1) Medium Base 75W max.

T24-1

82202EN7-12

(1) Med. Base LED 3000K, 9W, 800 Lumen lamp incl.

T24-2 EN*

FINISH CODE

(-12) Black

A. EXTRA LARGE LANTERN

W: 12" H: 26.875" E: 14.25"
 Height from center of outlet box up: 9.5" down: 17.375"
 WET SS

OL15204ANBZ

(4) Candelabra Base 60W max



A

Antique Bronze Finish (ANBZ)
 Water Glass

B. LARGE LANTERN

W: 10" H: 22.25" E: 12"
 Height from center of outlet box up: 8.25" down: 14"
 WET SS

OL15203ANBZ

(3) Candelabra Base 60W max

C. MEDIUM LANTERN

W: 8.5" H: 19.25" E: 10.25"
 Height from center of outlet box up: 7" down: 12.25"
 WET SS

OL15202ANBZ

(1) Medium 75W max

D. SMALL LANTERN

W: 6.75" H: 15.5" E: 8.25"
 Height from center of outlet box up: 5.75" down: 9.75"
 WET SS

OL15201ANBZ

(1) Medium 75W max

E. EXTRA SMALL LANTERN

W: 6.75" H: 12" E: 8.25"
 Height from center of outlet box up: 5.25" down: 6.75"
 WET SS

OL15200ANBZ

(1) Medium 75W max



B

Antique Bronze Finish (ANBZ)
 Water Glass



C

Antique Bronze Finish (ANBZ)
 Water Glass



D

Antique Bronze Finish (ANBZ)
 Water Glass



E

Antique Bronze Finish (ANBZ)
 Water Glass

FINISH CODE

(ANBZ) Antique Bronze

F. POST LANTERN

D: 10" H: 24.5"

WET SS

OL15207ANBZ

(3) Candelabra Base 60W max

G. PENDANT

D: 10" H: 21.375"

15' Wire, 5' Chain

DAMP SS

OL15209ANBZ

(3) Candelabra Base 60W max



F

Antique Bronze Finish (ANBZ)
Water Glass



G

Antique Bronze Finish (ANBZ)
Water Glass

FINISH CODE

(ANBZ) Antique Bronze

SS All Millbrooke Fixtures are built with StoneStrong Composite Material.

StoneStrong Material is rust-proof and built to last in any outside environment, including Coastal, Dry, and Harsh Winter or Summer climates. StoneStrong is also backed by a robust 5-year warranty.

A. LARGE LANTERN

W: 9.5" H: 24.75" E: 11"
 Height from center of outlet box
 up: 9.625"

WET

OL7623ES

(3) Candelabra Base 60W max

B. MEDIUM LANTERN

W: 7.625" H: 20.625" E: 9.125"
 Height from center of outlet box
 up: 8.5"

WET

OL7622ES

(2) Candelabra Base 60W max

C. SMALL LANTERN

W: 6.125" H: 16.875" E: 7.5"
 Height from center of outlet box
 up: 4.875"

WET

OL7621ES

(1) Medium 75W max



A

Espresso Finish (ES)
 Clear Seeded Glass



B

Espresso Finish (ES)
 Clear Seeded Glass



C

Espresso Finish (ES)
 Clear Seeded Glass

D. POST LANTERN

D: 9.5" H: 28.125"
 1' Wire

WET

OL7627ES

(3) Candelabra Base 60W max

D. FLUSH MOUNT

D: 14" H: 4.875"
 1' Wire

DAMP

OL7633ES

(3) Medium 60W max



D

Espresso Finish (ES)
 Clear Seeded Glass



E

Espresso Finish (ES)
 Clear Seeded Glass

FINISH CODE

(ES) Espresso

A. LARGE LANTERN

W: 9.5" H: 24.75" E: 11"
 Height from center of outlet box
 up: 9.625"

WET

OL7602ES

(1) Medium A21 75W max

B. MEDIUM LANTERN

W: 7.625" H: 20.625" E: 9.125"
 Height from center of outlet box
 up: 8.5"

WET

OL7601ES

(1) Medium A21 75W max

C. SMALL LANTERN

W: 6.125" H: 16.785" E: 7.5"
 Height from center of outlet box
 up: 4.875"

WET

OL7604ES

(1) Medium A19 60W max

D. EXTRA SMALL LANTERN

W: 4.75" H: 13.25" E: 5.75"
 Height from center of outlet box
 up: 3.75"

WET

OL7600ES

(1) Medium A19 75W max

E. FLUSH MOUNT

D: 14" H: 4.875"

DAMP

OL7613ES

(3) Medium A19 60W max



A

Espresso Finish (ES)
 Acid Etched Outside Spray
 White Inside Glass



B

Espresso Finish (ES)
 Acid Etched Outside Spray
 White Inside Glass



C

Espresso Finish (ES)
 Acid Etched Outside Spray
 White Inside Glass



D

Espresso Finish (ES)
 Acid Etched Outside Spray
 White Inside Glass



E

Espresso Finish (ES)
 Acid Etched Outside Spray
 White Inside Glass

FINISH CODE

(ES) Espresso



PRODUCT SHOWN: CALDER SMALL ONE LIGHT OUTDOOR WALL LANTERN IN ANTIQUE BRONZE FINISH

**A. LARGE ONE LIGHT
OUTDOOR WALL LANTERN**

W: 10" H: 16.5" E: 11.375"
Height from the center of outlet box
up: 5.375"

WET SS

8750701-71

(1) Medium Base 75W max.

T24-1

8750701EN3-71

(1) Med. Base LED 3000K,
9W, 800 Lumen lamp incl.

T24-2 EN*



A

Antique Bronze Finish (-71)
Satin Etched Glass



B

Antique Bronze Finish (-71)
Satin Etched Glass

**B. MEDIUM ONE LIGHT
OUTDOOR WALL LANTERN**

W: 7.875" H: 12.25" E: 9.125"
Height from the center of outlet box
up: 4.375"

WET SS

8650701-71

(1) Medium Base 75W max.

T24-1

8650701EN3-71

(1) Med. Base LED 3000K,
9W, 800 Lumen lamp incl.

T24-2 EN*

**C. SMALL ONE LIGHT
OUTDOOR WALL LANTERN**

W: 6" H: 10" E: 7.25"
Height from the center of outlet box
up: 4"

WET SS

8550701-71

(1) Medium Base 75W max.

T24-1

8550701EN3-71

(1) Med. Base LED 3000K,
9W, 800 Lumen lamp incl.

T24-2 EN*



C

Antique Bronze Finish (-71)
Satin Etched Glass

**D. ONE LIGHT OUTDOOR
POST LANTERN**

D: 10" H: 20"

WET SS

8250701-71

(1) Medium Base 75W max.

T24-1

8250701EN3-71)

(1) Med. Base LED 3000K,
9W, 800 Lumen lamp incl.

T24-2 EN*



D

Antique Bronze Finish (-71)
Satin Etched Glass

FINISH CODE

(-71) Antique Bronze

SS All Calder Fixtures are built with StoneStrong Composite Material.

StoneStrong Material is rust-proof and built to last in any outside environment, including Coastal, Dry, and Harsh Winter or Summer climates. StoneStrong is also backed by a robust 5-year warranty.

A. LARGE LANTERN

W: 9" H: 14.375" E: 11"

Height from center of outlet box up: 6.25"

WET

OL2200BB

(1) Medium Base 75W max

B. SMALL PENDANT

W: 4.5" H: 11.125" E: 6.25"

Height from center of outlet box up: 3.5"

WET

OL2202BB

(1) Medium Base 75W max



A

Burnished Bronze Finish (BB)
Opal Etched Glass



B

Burnished Bronze Finish (BB)
Opal Etched Glass

FINISH CODE

(BB) Burnished Bronze

A. LARGE LANTERN

W: 8.5" H: 18.25" E: 8"
 Supplied with 6' of wire, (3) 12" Stems,
 (1) 6" Stem



OL12902TXB

(1) Medium A19 75W max.

B. MEDIUM LANTERN

W: 7.5" H: 13.5" H: 7"
 Supplied with 6' of wire, (3) 12" Stems,
 (1) 6" Stem



OL12901TXB

(1) Medium A19 75W max.

C. SMALL LANTERN

W: 6.375" H: 11.5" E: 6"
 Supplied with 6' of wire, (3) 12" Stems,
 (1) 6" Stem



OL12900TXB

(1) Medium A19 60W max.



A

Textured Black Finish (TXB)
 White Opal Etched Glass



B

Textured Black Finish (TXB)
 White Opal Etched Glass



C

Textured Black Finish (TXB)
 White Opal Etched Glass

FINISH CODE

(TXB) Textured Black

All Roscoe Fixtures are built with StoneStrong Composite Material.

StoneStrong Material is rust-proof and built to last in any outside environment, including Coastal, Dry, and Harsh Winter or Summer climates. StoneStrong is also backed by a robust 5-year warranty.

A. ONE LIGHT OUTDOOR WALL LANTERN

W: 5.75" H: 8.75" E: 4.5"
 Height from center of outlet box up: 5"

WET

8788(-15 -155 -10 -12)

(1) Medium Base 75W max.

T24-1

8988EN3(-15 -155 -10 -12)

(1) Med. Base LED 3000K, 9W, 800 Lumen lamp incl.

T24-2 EN*



A

Bronze Finish (-10)
 White Glass



Black Finish (-12)
 White Glass

B. ONE LIGHT OUTDOOR WALL LANTERN

W: 5.75" H: 8.75" E: 4.5"
 Height from center of outlet box up: 5"

WET

8588(-15 -155 -10 -12)

(1) Medium Base 75W max.

T24-1

8588EN7)-15 -155 -10 -12)

(1) Med. Base LED 3000K, 9W, 800 Lumen lamp incl.

T24-2 EN*



B

White Finish (-15)
 Clear Beveled Glass



Pewter Finish (-155)
 Clear Beveled Glass

FINISH CODES

- (-15) White
- (-155) Pewter
- (-155) Bronze
- (-12) Black

**A. LARGE ONE LIGHT
OUTDOOR WALL LANTERN**

W: 4.5" H: 10.25" E: 5.75"
Height from center of outlet box
up: 2.75"

WET

8593001(-15 -965 -71 -12)

(1) Medium Base 75W max.

T24-1

8593001EN3(-15 -965 -71 -12)

(1) Med. Base LED 3000K,
9W, 800 Lumen lamp incl.

T24-2 EN*



A

White Finish (-15)
Satin Etched Glass



B

Antique Brushed Nickel Finish (-965)
Clear Glass

**B. LARGE ONE LIGHT
OUTDOOR WALL LANTERN**

W: 4.5" H: 10.25" E: 5.75"
Height from center of outlet box
up: 2.75"

WET

8593(-15 -965 -71 -12)

(1) Medium Base 75W max.

T24-1

8593EN7(-15 -965 -71 -12)

(1) Med. Base LED 3000K,
9W, 800 Lumen lamp incl.

T24-2 EN*

**C. SMALL ONE LIGHT
OUTDOOR WALL LANTERN**

W: 4.25" H: 8.25" E: 5.5"
Height from center of outlet box
up: 2.75"

WET

8592001(-15 -965 -71 -12)

(1) Medium Base 75W max.

T24-1

8592001EN3(-15 -965 -71 -12)

(1) Med. Base LED 3000K,
9W, 800 Lumen lamp incl.

T24-2 EN*



C

Antique Bronze Finish (-71)
Satin Etched Glass



D

Black Finish (-12)
Clear Glass

**D. SMALL ONE LIGHT
OUTDOOR WALL LANTERN**

W: 4.25" H: 8.25" E: 5.5"
Height from center of outlet box
up: 2.75"

WET

8592(-15 -965 -71 -12)

(1) Medium Base 75W max.

T24-1

8592EN7(-15 -965 -71 -12)

(1) Med. Base LED 3000K,
9W, 800 Lumen lamp incl.

T24-2 EN*

FINISH CODES

- (-15) White
- (-965) Antique Brushed Nickel
- (-71) Antique Bronze Finish
- (-12) Black

**A. LARGE ONE LIGHT
OUTDOOR WALL LANTERN**

W: 9" H: 14" E: 10.5"
Height from center of outlet box up: 3.25"

WET

88027(-57 -12)

(1) Medium Base 75W max.

T24-1

88027EN7(-57 -12)

(1) Med. Base LED 3000K,
9W, 800 Lumen lamp incl.

T24-2 EN *



A

Weathered Pewter Finish (-57)
Clear Seeded Glass



B

Black Finish (-12)
Clear Seeded Glass

**B. SMALL ONE LIGHT
OUTDOOR WALL LANTERN**

W: 7" H: 11" E: 8.5"
Height from center of outlet box up: 3.25"

WET

88025(-57 -12)

(1) Medium Base 60W max.

T24-1

88025EN7(-57 -12)

(1) Med. Base LED 3000K,
9W, 800 Lumen lamp incl.

T24-2 EN *

**C. TWO LIGHT OUTDOOR
CEILING FLUSH MOUNT**

L: 10" W: 10" H: 6.25"

DAMP

78027(-57 -12)

(2) Medium Base 75W max.

T24-1



C

Black Finish (-12)
Clear Seeded Glass

**D. ONE LIGHT OUTDOOR
POST LANTERN**

L: 9" W: 9" H: 15"

WET

82027(-57 -12)

(1) Medium Base 75W max.

T24-1

82027EN7(-57 -12)

(1) Med. Base LED 3000K,
9W, 800 Lumen lamp incl.

T24-2 EN *



D

Weathered Pewter Finish (-57)
Clear Seeded Glass

**E. ONE LIGHT
OUTDOOR PENDANT**

L: 9" W: 9" H: 13.75"
12' Wire pre-laced through 10' Chain

DAMP

62027(-57 -12)

(1) Medium Base 75W max.

T24-1

78027EN7(-57 -12)

(1) Med. Base LED 3000K,
9W, 800 Lumen lamp incl.

T24-2 EN *



E

Black Finish (-12)
Clear Seeded Glass

FINISH CODES

(-57) Weathered Pewter
(-12) Black

F. LARGE ONE LIGHT OUTDOOR WALL LANTERN

W: 9" H: 14" E: 10.5"
 Height from center of outlet box up: 3.25"

WET

89031(-57 -12)

(1) Medium Base 75W max.

T24-1

89031EN3(-57 -12)

(1) Med. Base LED 3000K, 9W, 800 Lumen lamp incl.

T24-2 EN*

8903197S-12

LED: 2700K, 14 Watts, 1000 Lumens

T24-4 WOD EN* LED



F

Black Finish (-57)
 Etched Seeded Glass



G

Weathered Pewter Finish (-57)
 Etched Seeded Glass

G. SMALL ONE LIGHT OUTDOOR WALL LANTERN

W: 7" H: 11" E: 8.5"
 Height from center of outlet box up: 3.25"

WET

89029(-57 -12)

(1) Medium Base 60W max.

T24-1

89029EN3(-57 -12)

(1) Med. Base LED 3000K, 9W, 800 Lumen lamp incl.

T24-2 EN*

8902997S(-57 -12)

LED: 2700K, 9 Watts, 700 Lumens

T24-4 WOD EN* LED

H. TWO LIGHT OUTDOOR CEILING FLUSH MOUNT

L: 10" W: 10" H: 6.25"

DAMP

79039(-57 -12)

(2) Medium Base 75W max.

T24-1

79039EN3(-57 -12)

(2) Med. Base LED 3000K, 9W, 800 Lumen lamps incl.

T24-2 EN*

7903997S(-57 -12)

LED: 2700K, 14 Watts, 1000 Lumens

T24-4 WOD EN* LED



H

Weathered Pewter Finish (-57)
 Swirled Marbleized Glass

I. ONE LIGHT OUTDOOR POST LANTERN

L: 9" W: 9" H: 15"

WET

89129(-57 -12)

(1) Medium Base 75W max.

T24-1

89129EN3(-57 -12)

(1) Med. Base LED 3000K, 9W, 800 Lumen lamp incl.

T24-2 EN*



I

Black Finish (-12)
 Swirled Marbleized Glass

J. ONE LIGHT OUTDOOR PENDANT

L: 9" W: 9" H: 13.75"
 12' Wire pre-laced through 10' Chain

DAMP

69029(-57 -12)

(1) Medium Base 75W max.

T24-1

69029EN3(-57 -12)

(1) Med. Base LED 3000K, 9W, 800 Lumen lamp incl.

T24-2 EN*

6902997S(-57 -12)

LED: 2700K, 14 Watts, 1000 Lumens

T24-4 WOD EN* LED



J

Weathered Pewter Finish (-57)
 Swirled Marbleized Glass

FINISH CODES

(-57) Weathered Pewter
 (-12) Black

A. LARGE LANTERN

W: 9" H: 25" E: 6.5"
Height from center of outlet box
up: 9"
WET

OL2602ORB

(3) Candelabra Base 60W max

B. MEDIUM LANTERN

W: 6.75" H: 19" E: 5"
Height from center of outlet box
up: 6.75"
WET

OL2601ORB

(2) Candelabra Base 60W max



A

Oil Rubbed Bronze Finish (ORB)
Clear Seeded Glass



B

Oil Rubbed Bronze Finish (ORB)
Clear Seeded Glass

FINISH CODE

(ORB) Oil Rubbed Bronze

A. LARGE LANTERN

W: 9" H: 22.5" E: 4.875"
Height from center of outlet box up: 9.875"

WET

OL7402ASTB

(3) Candelabra B Torpedo 60W max

B. SMALL LANTERN

W: 6" H: 17.25" E: 4.875"
Height from center of outlet box up: 7"

WET

OL7400ASTB

(2) Candelabra Base 60W max



A

Astral Bronze Finish (ASTB)
Clear Seeded Glass



B

Astral Bronze Finish (ASTB)
Clear Seeded Glass

FINISH CODE

(ASTB) Astral Bronze

**A. LARGE ONE LIGHT
OUTDOOR WALL LANTERN**

W: 11" H: 17" E: 12"
Height from center of outlet box
up: 9.75"

WET

88882-51

(1) Medium Base 75W max.

T24-1

88882EN3-51

(1) Med. Base LED 3000K,
9W, 800 Lumen lamp incl.

T24-2 EN*



A

Statuary Bronze Finish (-51)
Etched Hammered Glass With Light Amber Tint

**B. MEDIUM ONE LIGHT
OUTDOOR WALL LANTERN**

W: 9" H: 14.25" E: 10"
Height from center of outlet box
up: 8.5"

WET

88881-51

(1) Medium Base 75W max.

T24-1

88881EN3-51

(1) Med. Base LED 3000K,
9W, 800 Lumen lamp incl.

T24-2 EN*

**C. SMALL ONE LIGHT
OUTDOOR WALL LANTERN**

W: 7" H: 11" E: 8"
Height from center of outlet box
up: 6.5"

WET

88880-51

(1) Medium Base 75W max.

T24-1

88880EN3-51

(1) Med. Base LED 3000K,
9W, 800 Lumen lamp incl.

T24-2 EN*



B

Statuary Bronze Finish (-51)
Etched Hammered Glass With Light Amber Tint



C

Statuary Bronze Finish (-51)
Etched Hammered Glass With Light Amber Tint

FINISH CODE

(-51) Statuary Bronze

A. LARGE LANTERN

W: 8.875" H: 20.125" E: 8.625"
 Height from center of outlet box up: 13.5"

WET SS

OL14372CO

(3) Candelabra Torpedo 60W max.



A

Copper Oxide Finish (CO)

FINISH CODE

(CO) Copper Oxide

LENNEX

A. RECTANGULAR PLATE LANTERN

W: 12" H: 17.25" E: 15.5"
 Height from the center of outlet box up: 11.25"

WET

WB1828SGM

(1) Medium A19 60W max.



A

Slate Grey Metal Finish (SGM)

FINISH CODE

(SGM) Slate Grey Metal

DARBY

A. LANTERN

W: 7.5" H: 9.25" E: 8.875"
 Height from center of outlet box up: 6"

WET

OL8701ORB

(1) Medium 75W max



A

Oil Rubbed Bronze Finish (ORB)

FINISH CODE

(ORB) Oil Rubbed Bronze



PRODUCT SHOWN: CRITTENDEN ONE LIGHT OUTDOOR
WALL LANTERN IN SATIN ALUMINUM FINISH

**A. LARGE ONE LIGHT
OUTDOOR WALL LANTERN**

W: 13" H: 10.375" E: 15.125"
Height from center of outlet box
up: 3.375"

WET ☾

8638501-12

(1) Medium Base 75W max.

T24-1

8638501EN3-12

(1) Med. Base LED 3000K,
9W, 800 Lumen lamp incl.

T24-2 EN*



A

Black Finish (-12)

**B. MEDIUM ONE LIGHT
OUTDOOR WALL LANTERN**

W: 10" H: 8.5" E: 11.375"
Height from center of outlet box
up: 2.5"

WET ☾

8538501(-04 -12)

(1) Medium Base 75W max.

T24-1

8538501EN3(-04 -12)

(1) Med. Base LED 3000K,
9W, 800 Lumen lamp incl.

T24-2 EN*

**C. SMALL ONE LIGHT
OUTDOOR WALL LANTERN**

W: 8" H: 7.625" E: 9.125"
Height from center of outlet box
up: 2.5"

WET ☾

8438501-12

(1) Medium Base 75W max.

T24-1

8438501EN3-12

(1) Med. Base LED 3000K,
9W, 800 Lumen lamp incl.

T24-2 EN*



B

Satin Aluminum Finish (-04)



C

Black Finish (-12)

FINISH CODE

(-04) Satin Aluminum
(-12) Black

**A. LARGE ONE LIGHT
OUTDOOR WALL LANTERN**

W: 13.25" H: 16" E: 15.25"
Height from center of outlet box
up: 7.5"

WET ☾

8647701(-04 -44 -12)

(1) Medium Base 75W max.

T24-1

8647701EN3(-04 -44 -12)

(1) Med. Base LED 3000K,
9W, 800 Lumen lamp incl.

T24-2 EN*

8647701(-04 -44)/T

(1) Med. Base PAR 20 LED
7W, 340 Lumen lamp incl.

T24-4 



A

Satin Aluminum Finish (-04)

**B. SMALL ONE LIGHT
OUTDOOR WALL LANTERN**

W: 10" H: 12" E: 11.75"
Height from center of outlet box
up: 5.75"

WET ☾

8547701(-04 -44 -12)

(1) Medium Base 75W max.

T24-1

8547701EN3(-04 -44 -12)

(1) Med. Base LED 3000K,
9W, 800 Lumen lamp incl.

T24-2 EN*

8547701(-04 -44)/T

(1) Med. Base PAR 20 LED
7W, 340 Lumen lamp incl.

T24-4 



B

Weathered Copper Finish (-44)

**C. INDOOR / OUTDOOR
PENDANT**

D: 13.25" H: 11.5"
10' Wire, (3) 12" stems, (1) 6" Stem
Sloped ceiling mounting
hardware incl.

DAMP ☾

6247701(-04 -44 -12)

(1) Medium Base 75W max.

T24-1

6247701EN3(-04 -44 -12)

(1) Med. Base LED 3000K,
9W, 800 Lumen lamp incl.

T24-2 EN*



C

Black Finish (-12)

FINISH CODES

(-04) Satin Aluminum
(-44) Weathered Copper
(-12) Black

**A. LARGE ONE LIGHT
OUTDOOR WALL LANTERN**

W: 11.25" H: 15.75" E: 13.5"
Height from center of outlet box up: 9.5"

WET

8871(-98 -44 -12)

(1) Medium Base 75W max.

T24-1

8871EN3(-98 -44 -12)

(1) Med. Base LED 3000K,
9W, 800 Lumen lamp incl.

T24-2 EN*



A

Brushed Stainless Finish (-98), White Inside
Clear Seeded Glass



C

Brushed Stainless Finish (-98), White Inside
Clear Seeded Glass

**B. SMALL ONE LIGHT
OUTDOOR WALL LANTERN**

W: 8" H: 11.25" E: 9.25"
Height from center of outlet box
up: 6.25"

WET

8870(-98 -44 -12)

(1) Medium Base 75W max.

T24-1

8870EN3(-98 -44 -12)

(1) Med. Base LED 3000K,
9W, 800 Lumen lamp incl.

T24-2 EN*

**C. ONE LIGHT
OUTDOOR FLUSH MOUNT**

D: 11.25" H: 9.25"

DAMP

8869(-98 -44 -12)

(1) Medium Base 75W max.

T24-1

8869EN3(-98 -44 -12)

(1) Med. Base LED 3000K,
9W, 800 Lumen lamp incl.

T24-2 EN*



B

Weathered Copper Finish (-44)
Clear Seeded Glass



D

Black Finish (-12)
Clear Seeded Glass

**D. ONE LIGHT
OUTDOOR POST LANTERN**

D: 11.25" H: 15.75" E: 16"

WET

8269(-98 -44 -12)

(1) Medium Base 75W max.

T24-1

8269EN3(-98 -44 -12)

(1) Med. Base LED 3000K,
9W, 800 Lumen lamp incl.

T24-2 EN*

FINISH CODES

- (-98) Brushed Stainless
- (-44) Weathered Copper
- (-12) Black

REDDING STATION OUTDOOR



PRODUCT SHOWN: REDDING STATION SMALL OUTDOOR
WALL LANTERN IN RESTORATION BRONZE FINISH



A

Restoration Bronze Finish (RSZ)



B

Tarnished Silver Finish (TRD)



C

Textured Black Finish (TXB)



D

Textured Black Finish (TXB)

OUTDOOR WALL LANTERNS

PRODUCT	NO LAMP OPTION	INTEGRATED LED	WILDLIFE FRIENDLY LAMP
A. LARGE LANTERN W: 15" H: 15.625" E: 16.625" Height from center of outlet box up: 8.875" WET ☾	OL9004(RSZ TRD TXB) (1) Medium Base wA21 75W max	OL9004RSZ-L1 OL9004TRD-L1 OL9004TXB-L1 (1) LED Integrated Module 14W Bulb Lamp incl. T24-1 ☾	OL9004RSZ/T OL9004TRD/T OL9004TXB/T (1) Red LED Medium PAR20 7W Max Bulb Lamp incl. 🦋 ☾
B. MEDIUM LANTERN W: 12" H: 12.5" E: 13.4375" Height from center of outlet box up: 6" WET ☾	OL8601(RSZ TRD TXB) (1) Medium Base A21 75W max	OL8601RSZ-L1 OL8601TRD-L1 OL8601TXB-L1 (1) LED Integrated Module 14W Bulb Lamp incl. T24-1 ☾	OL8601RSZ/T OL8601TRD/T OL8601TXD/T (1) Red LED Medium PAR20 7W Max Bulb Lamp incl. 🦋 ☾
C. SMALL LANTERN W: 9" H: 9.6875" E: 10.375" Height from center of outlet box up: 4.25" WET ☾	OL8600(RSZ TRD TXB) (1) Medium Base A19 75W max	OL8600RSZ-L1 OL8600TRD-L1 OL8600TXB-L1 (1) LED Integrated Module 14W Bulb Lamp incl. T24-1 ☾	OL8600RSZ/T OL8600TRD/T OL8600TXB/T (1) Red LED Medium PAR20 7W Max Bulb Lamp incl. 🦋 ☾
D. PENDANT D: 12" H: 11" 15' Wire, 5' Chain DAMP ☾	OL8600(RSZ TRD TXB) (1) Medium Base A19 75W max	OL8600RSZ-L1 OL8600TRD-L1 OL8600TXB-L1 (1) LED Integrated Module 14W Bulb Lamp incl. T24-1 ☾	—

FINISH CODES

- (RSZ) Restoration Bronze
- (TRD) Tarnished Silver
- (TXB) Textured Black

A. ONE LIGHT OUTDOOR WALL LANTERN

L: 10" W: 5" H: 3.75" E: 3.75"
Height from center of outlet box
horizontal: 2.5" vertical: 5"

WET ADA +

8335(-15 -12)

(1) Medium Base 60W max.

T24-1

8335EN3(-15 -12)

(1) Med. Base LED 3000K,
9W, 800 Lumen lamp incl.

T24-2 EN*



A

White Finish (-15)
Frosted Ribbed Diffuser

B. ONE LIGHT OUTDOOR WALL LANTERN

L: 10" H: 5" E: 4"
Height from center of outlet box
horizontal: 2.5" vertical: 5"

WET ADA +

89806(-15 -12)

(1) Medium Base 60W max.

T24-1

89806EN3(-15 -12)

(1) Med. Base LED 3000K,
9W, 800 Lumen lamp incl.

T24-2 EN*



B

Black Finish (-12)
Frosted Ribbed Diffuser

C. ONE LIGHT OUTDOOR WALL LANTERN

L: 10" W: 5" H: 4" E: 4"
Height from center of outlet box up: 2.5"

WET ADA

89805(-15 -12)

(1) Medium Base 60W max.

T24-1

89805EN3(-15 -12)

(1) Med. Base LED 3000K,
9W, 800 Lumen lamp incl.

T24-2 EN*



C

White Polycarbonate Finish (-15)
Frosted Ribbed Diffuser

FINISH CODES

(-15) White
(-12) Black

D. ONE LIGHT OUTDOOR WALL / CEILING MOUNT

D: 10" H: 5" E: 5"
 Wall or Ceiling mount
 Height from center of outlet box up: 5"
 WET +

83057(-15 -12)
 (1) Medium Base 75W max.
 T24-1

83057EN3(-15 -12)
 (1) Med. Base LED 3000K,
 9W, 800 Lumen lamp incl.
 T24-2 EN*



D
 Black Finish (-12)
 Frosted Ribbed Diffuser

E. ONE LIGHT OUTDOOR WALL / CEILING MOUNT

D: 10" H: 5" E: 5"
 Wall or Ceiling mount
 Height from center of outlet box up: 5"
 WET +

89807(-15 -12)
 (1) Medium Base 75W max.
 T24-1

89807EN3(-15 -12)
 (1) Med. Base LED 3000K,
 9W, 800 Lumen lamp incl.
 T24-2 EN*



E
 White Finish (-15)
 Frosted Ribbed Diffuser

FINISH CODES

- (-15) White
- (-12) Black

A. ONE LIGHT OUTDOOR WALL LANTERN

W: 4.5" H: 7.5" E: 5.75"
 Height from center of outlet box up: 2.5"
WET

8909PEN3-12

(1) Med. Base LED 3000K, 9W, 800 Lumen lamp incl. photocell included

T24-2 EN *



A

Black Finish (-12)
 White Polycarbonate Diffuser



B

White Finish (-15)
 Clear Glass

B. ONE LIGHT OUTDOOR WALL LANTERN

W: 4.5" H: 6" E: 5.5"
 Height from center of outlet box up: 2.25"
WET

8750(-15 -12)

(1) Medium Base 60W max.

T24-1

8750EN7(-15 -12)

(1) Med. Base LED 3000K, 9W, 800 Lumen lamp incl.

T24-2 EN *

C. ONE LIGHT OUTDOOR WALL LANTERN

W: 4.5" H: 7.5" E: 5.75"
 Height from center of outlet box up: 2.25"
WET

8550-12

(1) Medium Base 75W max.

T24-1

8550EN7-12

(1) Med. Base LED 3000K, 9W, 800 Lumen lamp incl.

T24-2 EN *



C

Black Finish (-12)
 Clear Glass



D

Black Finish (-12)
 Satin Etched Glass

D. ONE LIGHT OUTDOOR WALL LANTERN

W: 4.5" H: 7.5" E: 5.75"
 Height from center of outlet box up: 2.25"
WET

8550001-12

(1) Medium Base 75W max.

T24-1

8550001EN3-12

(1) Med. Base LED 3000K, 9W, 800 Lumen lamp incl.

T24-2 EN *



E

White Finish (-15)
 White Glass



Black Polycarbonate Finish (-34)
 White Glass

E. ONE LIGHT OUTDOOR WALL LANTERN

W: 6" H: 7.25" E: 7"
 Height from center of outlet box up: 2.25"
WET

8753(-15 -34)

(1) Medium Base 60W max.

T24-1

8753EN3(-15 -34)

(1) Med. Base LED 3000K, 9W, 800 Lumen lamp incl.

T24-2 EN *

FINISH CODES

- (-15) White
- (-34) Black Polycarbonate
- (-12) Black

**A. HALF MOON ONE LIGHT
OUTDOOR WALL LANTERN**

W: 8" H: 10" E: 5.75"
Height from center of outlet box
up: 4.25"



8304701-714

(1) Medium Base 75W max.



8304701EN3-714

(1) Med. Base LED 3000K,
9W, 800 Lumen lamp incl.



8304701-714/T

(1) Med. Base PAR 20 LED
7W, 340 Lumen lamp incl.



A

Paintable Ceramic Finish (-714)

**B. RECTANGLE ONE LIGHT
OUTDOOR WALL LANTERN**

W: 8" H: 10" E: 5.75"
Height from center of outlet box
up: 4.25"



8304801-714

(1) Medium Base 75W max.



8304801EN3-714

(1) Med. Base LED 3000K,
9W, 800 Lumen lamp incl.



8304801-714/T

(1) Med. Base PAR 20 LED
7W, 340 Lumen lamp incl.



B

Paintable Ceramic Finish (-714)



C

Paintable Ceramic Finish (-714)

**C. STRIATION ONE LIGHT
OUTDOOR WALL LANTERN**

W: 8" H: 10" E: 5.75"
Height from center of outlet box
up: 4.25"



83046-714

(1) Medium Base 75W max.



83046EN3-714

(1) Med. Base LED 3000K,
9W, 800 Lumen lamp incl.



83046-714/T

(1) Med. Base PAR 20 LED
7W, 340 Lumen lamp incl.



FINISH CODE

(-714) Paintable Ceramic

WALL LANTERNS OUTDOOR

A. ONE LIGHT OUTDOOR WALL LANTERN

W: 8" H: 25" Without Tail H: 20" E: 9"
Height from center of outlet box up: 15.25"

WET +

8765(-15 -12)

(1) Medium Base 75W max.

T24-1

8765EN7(-15 -32)

(1) Med. Base LED 3000K,
9W, 800 Lumen lamp incl.

T24-2 EN*

B. ONE LIGHT OUTDOOR WALL LANTERN

W: 8" H: 17.5" E: 8.5"
Height from center of outlet
box up: 10.75"

WET

8720(-15 -32)

(1) Medium Base 60W max.

T24-1

8720EN7(-15 -32)

(1) Med. Base LED 3000K,
9W, 800 Lumen lamp incl.

T24-2 EN*



A

White Polycarbonate Finish (-15)
Clear Beveled Acrylic Panels



B

Black Polypropylene Finish (-32)
Clear Beveled Acrylic Diffuser

FINISH CODES

(-15) White Polycarbonate
(-32) Black Polypropylene
(-12) Black

A. TWO LIGHT OUTDOOR CEILING FLUSH MOUNT

D: 13" H: 5.5"

DAMP

7821402(-71 -12)

(2) Medium Base 60W max.

T24-1

7821402EN7(-71 -12)

(1) Med. Base LED 3000K, 9W, 800 Lumen lamp incl.

T24-2 EN*

B. TWO LIGHT OUTDOOR CEILING FLUSH MOUNT

L: 10.25" W: 10.25" H: 5.5"

DAMP

7569(-15 -32)

(2) Medium Base 60W max.

T24-1

7569EN3(-15 -32)

(2) Med. Base LED 3000K, 9W, 800 Lumen lamps incl.

T24-2 EN*



A

Antique Bronze Finish (-71)
Clear Seeded Glass



Black Finish (-12)
Clear Seeded Glass

C. ONE LIGHT OUTDOOR CEILING FLUSH MOUNT

L: 8.25" W: 8.25" H: 4.75"

DAMP

7567(-15 -32)

(1) Medium Base 60W max.

T24-1

7567EN3(-15 -32)

(1) Med. Base LED 3000K, 9W, 800 Lumen lamp incl.

T24-2 EN*



B

White Polypropylene Finish (-15)
Clear Textured Glass

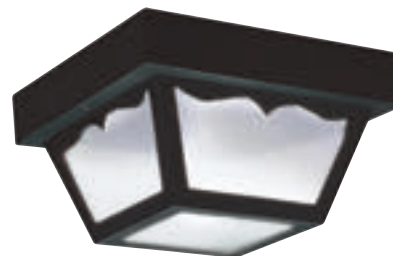

C

Black Polypropylene Finish (-15)
Clear Textured Glass

FINISH CODES

- (-15) White Polypropylene
- (-32) Black Polypropylene
- (-71) Antique Bronze
- (-12) Black

A. ONE LIGHT OUTDOOR POST LANTERN

L: 10.5 W: 10.5" H: 18"

WET

82065-12

(1) Medium Base 75W max.

T24-1

82065EN3-12

(1) Med. Base LED 3000K, 9W, 800 Lumen lamp incl.

T24-2 EN*



A

Black Polycarbonate Finish (-12)
Frosted Acrylic Diffuser



B

Black Polycarbonate Finish (-12)
Clear Beveled Acrylic Diffuser

B. ONE LIGHT OUTDOOR POST LANTERN

L: 8" W: 8" H: 18"

WET

8255-12

(1) Medium Base 75W max.

T24-1

8255EN7-12

(1) Med. Base LED 3000K, 9W, 800 Lumen lamp incl.

T24-2 EN*

C. ONE LIGHT OUTDOOR POST LANTERN

L: 8" W: 8" H: 11"

WET

8275-32

(1) Medium Base 60W max.

T24-1

8275EN7-32

(1) Med. Base LED 3000K, 9W, 800 Lumen lamp incl.

T24-2 EN*



C

Black Polypropylene Finish (-32)
Clear Beveled Acrylic Diffuser

FINISH CODES

- (-32) Black Polypropylene
- (-12) Black Polycarbonate

A. ONE LIGHT OUTDOOR POST LANTERN

D: 14" H: 15"

WET

8254-68

(1) Medium Base 75W max.

T24-1

8254EN3-68

(1) Med. Base LED 3000K, 9W, 800 Lumen lamp incl.

T24-2 EN*

B. ONE LIGHT OUTDOOR POST LANTERN

D: 12" H: 13"

WET

8252-68

(1) Medium Base 75W max.

T24-1

8252EN3-68

(1) Med. Base LED 3000K, 9W, 800 Lumen lamp incl.

T24-2 EN*



A

Black Polycarbonate Finish (-68)
White Acrylic Diffuser



B

Black Polycarbonate Finish (-68)
White Acrylic Diffuser

ADDRESS LIGHTS OUTDOOR



PRODUCT SHOWN: LED ADDRESS LIGHT IN ANTIQUE BRONZE FINISH

A. 120V LED ADDRESS LIGHT

W: 12.25" H: 7" E: 2.25"

WET

96091S(-15 -71 -12)

LED: 3000K, 120V, 2 Watts, 120 Lumens

LED



A

White Powdercoat Finish (-15)



B

Antique Bronze Powdercoat Finish (-71)

B. LOW-VOLTAGE ADDRESS LIGHT

W: 12.5" H: 7" E: 2.25"

WET

9600(-71 -12)

(2) Wedge Base T3/4 5W 16v lamps included



Antique Bronze Powdercoat Finish (-71)



Black Powdercoat Finish (-12)

C. LOW-VOLTAGE ADDRESS LIGHT TRANSFORMER

L: 2.5" W: 2.125" H: 2"

WET

9647

16V, Class II



C

D. NUMBER TILES

W: 2.25" H: 5"

WET



Black Powdercoat Finish (-12)

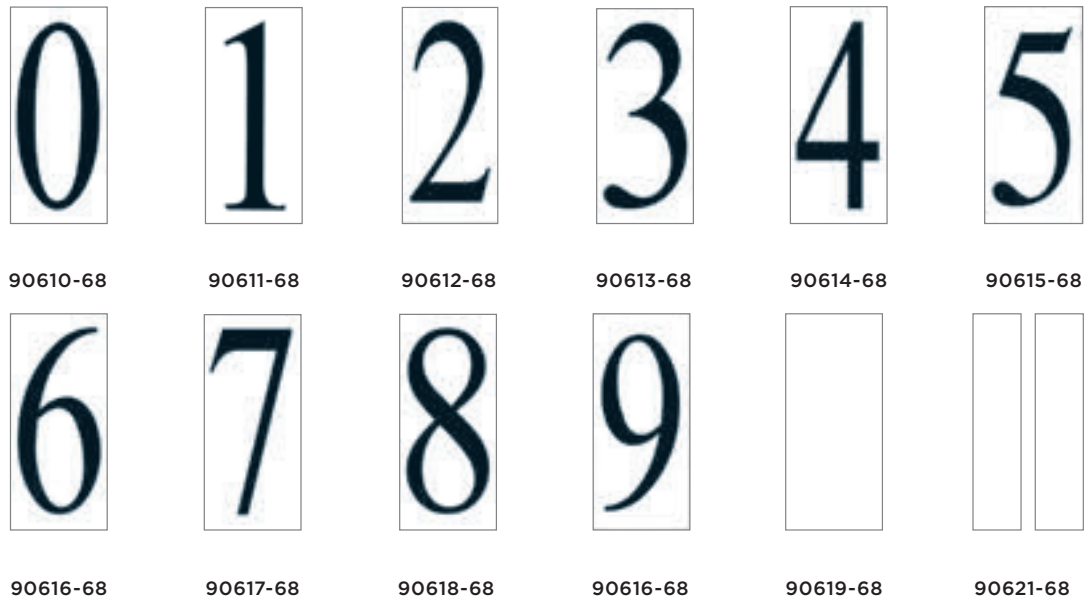

D

White Plastic Finish (-68)

FINISH CODES

- (-68) White Plastic
- (-15) White
- (-71) Antique Bronze
- (-12) Black

A. ONE LIGHT FLOOD LIGHT WITH PHOTO & MOTION SENSOR

W: 5.75" H: 12.25" E: 11.5"
 Height from center of outlet box up: 2.625"
 Head swivels
 WET +

8560701PM(-15 -71 -12)

(1) Medium BR40 120W max.

T24-1

8560701PMEN3(-15 -71 -12)

(1) Med. Base LED 3000K, 9W, 800 Lumen lamp incl.

T24-2 EN*

B. ONE LIGHT ADJUSTABLE SWIVEL FLOOD LIGHT

W: 5.6875" H: 12.25" E: 11.5"
 Height from center of outlet box up: 2.625"
 Head swivels
 WET +

8560701(-15 -71 -12)

(1) Medium Base BR40 75W max.

T24-1



A

White Finish (-15)
 White Aluminum



Black Finish (-12)
 Black Aluminum



B

White Finish (-15)
 White Aluminum



Black Finish (-12)
 Black Aluminum

FINISH CODES

- (-15) White
- (-71) Antique Bronze
- (-12) Black

C. TWO LIGHT FLOOD LIGHT WITH PHOTO & MOTION SENSOR

W: 22.5" H: 12.5" E: 11.5"
 Height from center of outlet box up: 2.625"
 Heads swivel

WET +

8560702PM(-15 -71 -12)

(2) Medium BR40 120W max.

T24-1

8560702PMEN3(-15 -71 -12)

(2) Med. Base LED 3000K, 9W, 800 Lumen lamps incl.

T24-2 EN*



C

Black Finish (-12)
 Black Aluminum

D. TWO LIGHT ADJUSTABLE SWIVEL FLOOD LIGHT

W: 22" H: 12.5" E: 11.5"
 Height from center of outlet box up: 2.625"
 Heads swivel

WET +

8560702(-15 -71 -12)

(2) Medium Base BR40 75W max.

T24-1

E. TWO LIGHT ADJUSTABLE SWIVEL FLOOD LIGHT

W: 9.5" H: 11" E: 2.5"
 Heads swivel

WET +

8642(-15 -12)

(2) Medium Base PAR38 90W max.

T24-1



D

Antique Bronze Finish (-71)
 Antique Bronze Aluminum



E

White Finish (-15)
 Polycarbonate

FINISH CODES

- (-15) White
- (-71) Antique Bronze
- (-12) Black

EXTRUDED ALUMINUM POSTS OUTDOOR

Generation Lighting lanterns fit only 3" diameter Generation Lighting lantern accessories.

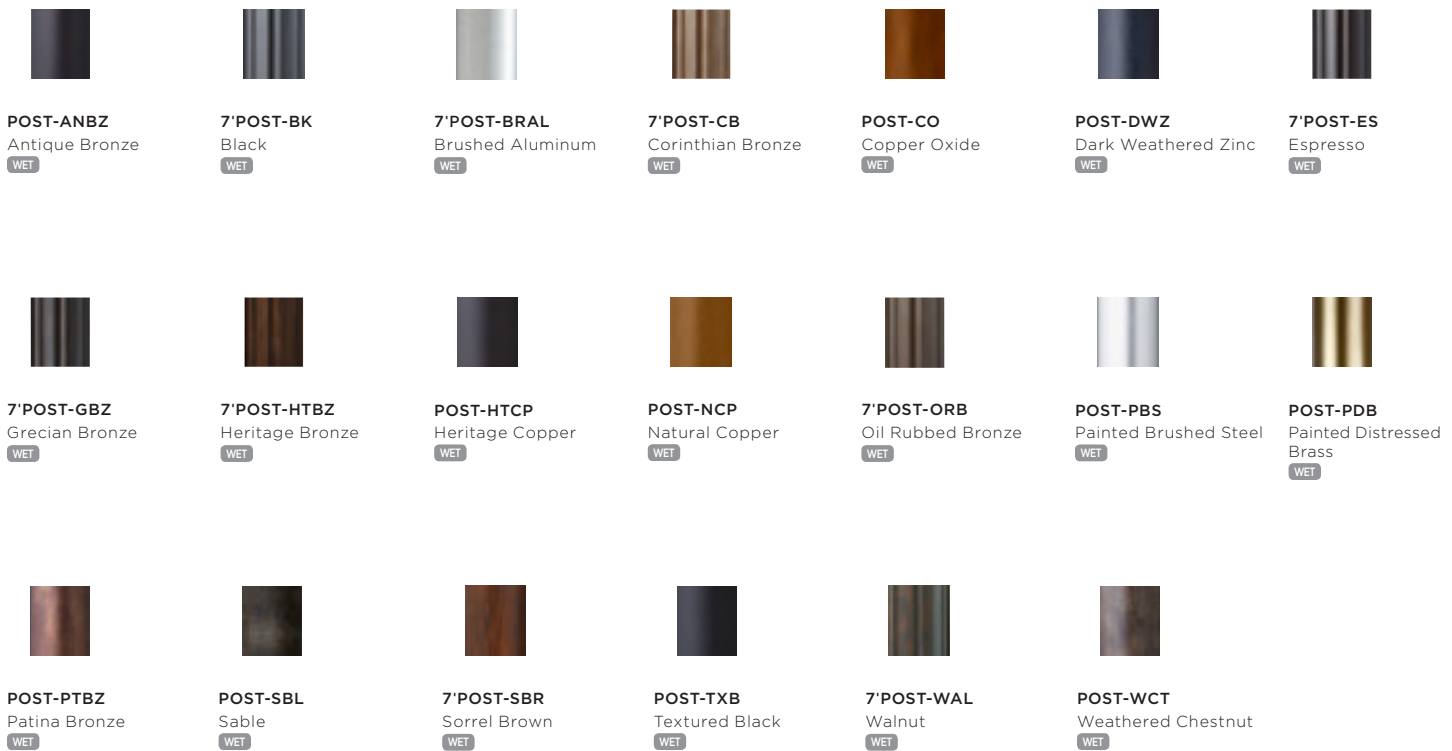

POSTS H: 7' D: 3"

PRODUCT #	FINISH	DETAILS
POST-ANBZ	Antique Bronze	Smooth
7'POST-BK	Black	Fluted
7'POST-BRAL	Brushed Aluminum	Smooth
7'POST-CB	Corinthian Bronze	Fluted
POST-CO	Copper Oxide	Smooth
POST-DWZ	Dark Weathered Zinc	Smooth
7'POST-ES	Espresso	Fluted
7'POST-GBZ	Grecian Bronze	Fluted
7'POST-HTBZ	Heritage Bronze	Fluted
POST-HTCP	Heritage Copper	Smooth

POSTS H: 7' D: 3"

PRODUCT #	FINISH	DETAILS
POST-NCP	Natural Copper	Smooth
7'POST-ORB	Oil Rubbed Bronze	Fluted
POST-PBS	Painted Brushed Steel	Smooth
POST-PDB	Painted Distressed Brass	Smooth
POST-PTBZ	Patina Bronze	Smooth
POST-SBL	Sable	Smooth
7'POST-SBR	Sorrel Brown	Smooth
POST-TXB	Textured Black	Smooth
7'POST-WAL	Walnut	Fluted
POST-WCT	Weathered Chestnut	Smooth

A. ALUMINUM POST

D: 3" H: 84"

WET

8101(-71 -12)

B. STEEL POST

D: 3" H: 84"

WET

8102(-15 -12)

C. ALUMINUM POST

D: 3" H: 84"

With Ladder Rest and Photocell

WET

8114-12



A

B

Antique Bronze Finish (-71) White Finish (-15)

D. ALUMINUM POST

D: 3" H: 84"

With Photocell

WET

8112-12

E. CAST ALUMINUM POST

W: 10.5" H: 71"

WET

8120-12



C

D

E

Black Finish (-12)

Black Finish (-12)

Black Finish (-12)

DIE-CAST ALUMINUM PIER MOUNTS OUTDOOR

Generation Lighting lanterns fit only 3" diameter Generation Lighting lantern accessories.



PIERMOUNT-ANBZ
Antique Bronze
WET



PIER MT-ASTB
Astral Bronze
WET



PIER MT-BK
Black
WET



PIER MT-BRAL
Brushed Aluminum
WET



PIER MT-CB
Corinthian Bronze
WET



PIERMOUNT-CO
Copper Oxide
WET



PIERMOUNT-DWZ
Dark Weathered Zinc
WET



PIER MT-ES
Espresso
WET



PIER MT-GBZ
Grecian Bronze
WET



PIER MT-HTBZ
Heritage Bronze
WET



PIERMOUNT-HTCP
Heritage Copper
WET



PIERMOUNT-NCP
Natural Copper
WET



PIER MT-ORB
Oil Rubbed Bronze
WET



PIERMOUNT-PBS
Painted Brushed Steel
WET



PIERMOUNT-PDB
Painted Distressed Brass
WET



PIERMOUNT-PTBZ
Patina Bronze
WET



PIERMOUNT-SBL
Sable
WET



PIER MT-SBR
Sorrel Brown
WET



PIERMOUNT-TXB
Textured Black
WET



PIER MT-WAL
Walnut
WET



PIERMOUNT-WCT
Weathered Chestnut
WET

PIER MOUNT H: 3.5" D: 6" sq.

PRODUCT #	FINISH	DETAILS
PIER MT-ANBZ	Antique Bronze	Fluted
PIER MT-ASTB	Astral Bronze	Fluted
PIER MT-BK	Black	Fluted
PIER MT-BRAL	Brushed Aluminum	Fluted
PIER MT-CB	Corinthian Bronze	Fluted
PIER MT-CO	Copper Oxide	Fluted
PIER MT-DWZ	Dark Weathered Zinc	Fluted
PIER MT-ES	Espresso	Fluted
PIER MT-GBZ	Grecian Bronze	Fluted
PIER MT-HTBZ	Heritage Bronze	Fluted
PIER MT-HTCP	Heritage Copper	Fluted

PIER MOUNT H: 3.5" D: 6" sq.

PRODUCT #	FINISH	DETAILS
PIER MT-NCP	Natural Copper	Fluted
PIER MT-ORB	Oil Rubbed Bronze	Fluted
PIER MT-PBS	Painted Brushed Steel	Fluted
PIER MT-PDB	Painted Distressed Brass	Fluted
PIER MT-PTBZ	Patina Bronze	Fluted
PIER MT-SBL	Sable	Fluted
PIER MT-SBR	Sorrel Brown	Smooth, Round
PIER MT-TXB	Textured Black	Fluted
PIER MT-WAL	Walnut	Fluted
PIER MT-WCT	Weathered Chestnut	Fluted

OUTDOOR DIE-CAST ALUMINUM POST BASES



POSTBASE-ANBZ
Antique Bronze
WET



POSTBASE ASTB
Astral Bronze
WET



POSTBASE BK
Black
WET



POSTBASE-CO
Copper Oxide
WET



POSTBASE-DWZ
Dark Weathered Zinc
WET



POSTBASE ES
Espresso
WET



POSTBASE GBZ
Grecian Bronze
WET



POSTBASE HTBZ
Heritage Bronze
WET



POSTBASE-NCP
Natural Copper
WET



POSTBASE ORB
Oil Rubbed Bronze
WET



POSTBASE-PBS
Painted Brushed Steel
WET



POSTBASE-PDB
Painted Distressed Brass
WET



POSTBASE-PTBZ
Patina Bronze
WET



POSTBASE-SBL
Sable
WET

POST BASES H: 19.5" D: 10"

PRODUCT #	FINISH	DETAILS
POSTBASE-ANBZ	Antique Bronze	Smooth
POSTBASE ASTB	Astral Bronze	Fluted
POSTBASE BK	Black	Fluted
POSTBASE-CO	Copper Oxide	Smooth
POSTBASE-DWZ	Dark Weathered Zinc	Smooth
POSTBASE ES	Espresso	Fluted
POSTBASE GBZ	Grecian Bronze	Fluted

POST BASES H: 19.5" D: 10"

PRODUCT #	FINISH	DETAILS
POSTBASE HTBZ	Heritage Bronze	Fluted
POSTBASE-NCP	Natural Copper	Fluted
POSTBASE ORB	Oil Rubbed Bronze	Fluted
POSTBASE-PBS	Painted Brushed Steel	Smooth
POSTBASE-PDB	Painted Distressed Brass	Smooth
POSTBASE-PTBZ	Patina Bronze	Smooth
POSTBASE-SBL	Sable	Smooth



PRODUCT SHOWN: JOVIE 58 IN BRUSHED STEEL
HOUSING WITH SILVER ABS BLADES

CEILING FANS

JOVIE 58 LED CEILING FANS

JOVIE 58 LED

EN★ LED DAMP WET DC

BLADES

(3) Blades (Included)
12° Blade Pitch
58" Blade Sweep

BLADE MATERIAL

ABS

LAMPING

Integrated LED: 20W
Light Output: 960 Lumens Net
CCT: 2700K, 3000K and 4000K
CRI: 90+

MOUNTING

Maximum Slope Angle with
Included Hardware: 20°

INCLUDED CONTROLS

Handheld Remote, 6-speed,
Reverse and Dimmer



COMPATIBLE ACCESSORIES

Wall Control ESSWC-10 (pg. 398)
Slope Ceiling Canopy Kits MC95 & MC93 (pg. 400)

FAN SPECIFICATIONS

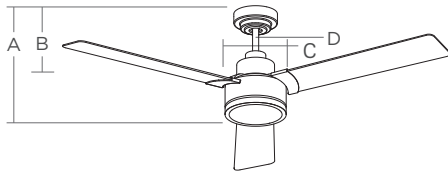

- A. Fixture Drop: 14.7"
- B. Blade Drop: 11.7"
- C. Housing Width: 8.3"
- D. Downrod: 6" (additional lengths pg. 401)

Motor Size: 178mm x 12mm

FTC ENERGY GUIDE

STANDARD	HIGH SPEED	WEIGHTED AVERAGE
ELECTRICITY	20 Watts	14 Watts
AIRFLOW	5648 CFM	4062 CFM
ENERGY COSTS	N/A	\$4 Per Year
EFFICIENCY	288 CFM/Watt	282 CFM/Watt



DAMP

3JVR58BSD

Brushed Steel Housing
Silver ABS Blades
Frosted Acrylic Lens



WET

3JVR58AGPD

Aged Pewter Housing
Light Grey Weathered Oak ABS Blades
Frosted Acrylic Lens



WET

3JVR58MBKD

Midnight Black Housing
Midnight Black ABS Blades
Frosted Acrylic Lens

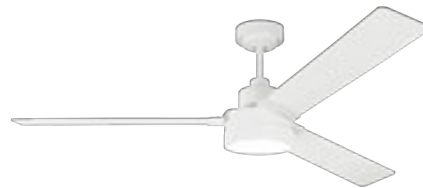

WET

3JVR58RZWD

Matte White Housing
Matte White ABS Blades
Frosted Acrylic Lens

JOVIE 58

EN★ DAMP WET DC

BLADES

(3) Blades (Included)
 12° Blade Pitch
 58" Blade Sweep

BLADE MATERIAL

ABS

MOUNTING

Maximum Slope Angle with
 Included Hardware: 20°

INCLUDED CONTROLS

Handheld Remote,
 6-speed, Reverse



COMPATIBLE ACCESSORIES

Wall Control ESSWC-10 (pg. 398)
 Slope Ceiling Canopy Kits MC95 & MC93 (pg. 400)

FAN SPECIFICATIONS

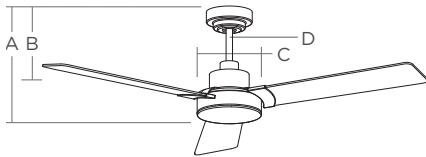

- A. Fixture Drop: 13.5"
- B. Blade Drop: 11.6"
- C. Housing Width: 8.3"
- D. Downrod: 6" (additional lengths pg. 401)

Motor Size: 178mm x 12mm

FTC ENERGY GUIDE

STANDARD	HIGH SPEED	WEIGHTED AVERAGE
ELECTRICITY	18 Watts	14 Watts
AIRFLOW	5551 CFM	3968 CFM
ENERGY COSTS	N/A	\$4 Per Year
EFFICIENCY	315 CFM/Watt	288 CFM/Watt



DAMP

3JVR58BS
 Brushed Steel Housing
 Silver ABS Blades



WET

3JVR58AGP
 Aged Pewter Housing
 Light Grey Weathered Oak ABS Blades



WET

3JVR58MBK
 Midnight Black Housing
 Midnight Black ABS Blades



WET

3JVR58RZW
 Matte White Housing
 Matte White ABS Blades

JOVIE 52 LED CEILING FANS



PRODUCT SHOWN: JOVIE 52 LED IN BRUSHED STEEL HOUSING WITH SILVER/AMERICAN WALNUT REVERSIBLE BLADES AND FROSTED ACRYLIC LENS

JOVIE 52 LED

LED DAMP

BLADES

(3) Blades (Included)
 12° Blade Pitch
 52" Blade Sweep

BLADE MATERIAL

Plywood

LAMPING

Integrated LED: 20W
 Light Output: 850 Lumens
 CCT: 2700K, 3000K and 4000K
 CRI: 90+

MOUNTING

Maximum Slope Angle with
 Included Hardware: 20°

INCLUDED CONTROLS

3-Wire Wall Mount Control, 4-speed,
 Dimmer and Manual Reverse



COMPATIBLE ACCESSORIES

See Control Compatibility Chart (pg. 397)
 Slope Ceiling Canopy Kits MC95 & MC93 (pg. 400)

FAN SPECIFICATIONS

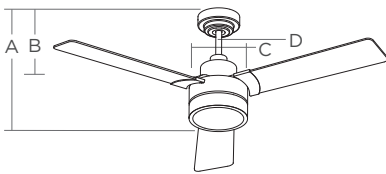

- A. Fixture Drop: 15.4"
- B. Blade Drop: 11.6"
- C. Housing Width: 8.3"
- D. Downrod: 6" (additional lengths pg. 401)

Motor Size: 153mm x 15mm

FTC ENERGY GUIDE

STANDARD	HIGH SPEED	WEIGHTED AVERAGE
ELECTRICITY	61 Watts	36 Watts
AIRFLOW	5223 CFM	3535 CFM
ENERGY COSTS	N/A	\$10 Per Year
EFFICIENCY	86 CFM/Watt	99 CFM/Watt



REV

3JVR52BSD
 Brushed Steel Housing
 Silver/American Walnut Reversible Blades
 Frosted Acrylic Lens



3JVR52AGPD
 Aged Pewter Housing
 Light Grey Weathered Oak Blades
 Frosted Acrylic Lens



3JVR52RZWD
 Matte White Housing
 Matte White Blades
 Frosted Acrylic Lens



REV

3JVR52MBKD
 Midnight Black Housing
 Midnight Black/American Walnut Reversible Blades
 Frosted Acrylic Lens

JOVIE 52

DAMP

BLADES

(3) Blades (Included)
12° Blade Pitch
52" Blade Sweep

BLADE MATERIAL

Plywood

MOUNTING

Maximum Slope Angle with
Included Hardware: 20°

INCLUDED CONTROLS

Wall Mount Control, 4-speed,
Manual Reverse



COMPATIBLE ACCESSORIES

See Control Compatibility Chart (pg. 397)
Slope Ceiling Canopy Kits MC95 & MC93 (pg. 400)

FAN SPECIFICATIONS

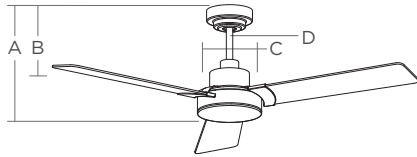

- A. Fixture Drop: 13.5"
- B. Blade Drop: 11.6"
- C. Housing Width: 8.3"
- D. Downrod: 6" (additional lengths pg. 401)

Motor Size: 153mm x 15mm

FTC ENERGY GUIDE

STANDARD	HIGH SPEED	WEIGHTED AVERAGE
ELECTRICITY	62 Watts	35 Watts
AIRFLOW	5901 CFM	4128 CFM
ENERGY COSTS	N/A	\$10 Per Year
EFFICIENCY	95 CFM/Watt	117 CFM/Watt



REV

3JVR52BS
Brushed Steel Housing
Silver/American Walnut Reversible Blades



3JVR52AGP
Aged Pewter Housing
Light Grey Weathered Oak Blades



3JVR52RZW
Matte White Housing
Matte White Blades



REV

3JVR52MBK
Midnight Black Housing
Midnight Black/American Walnut Reversible Blades

JOVIE 44 LED

LED DAMP

BLADES

(3) Blades (Included)
 12° Blade Pitch
 44" Blade Sweep

BLADE MATERIAL

Plywood

LAMPING

Integrated LED: 20W
 Light Output: 850 Lumens
 CCT: 2700K, 3000K and 4000K
 CRI: 90+

MOUNTING

Maximum Slope Angle with
 Included Hardware: 20°

INCLUDED CONTROLS

3-Wire Wall Mount Control, 4-speed,
 Dimmer and Manual Reverse



COMPATIBLE ACCESSORIES

See Control Compatibility Chart (pg. 397)
 Slope Ceiling Canopy Kits MC95 & MC93 (pg. 400)

FAN SPECIFICATIONS

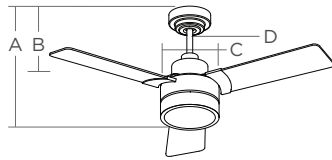

- A. Fixture Drop: 15.4"
- B. Blade Drop: 11.6"
- C. Housing Width: 8.3"
- D. Downrod: 6" (additional lengths pg. 401)

Motor Size: 153mm x 12mm

FTC ENERGY GUIDE

STANDARD	HIGH SPEED	WEIGHTED AVERAGE
ELECTRICITY	48 Watts	30 Watts
AIRFLOW	3928 CFM	2828 CFM
ENERGY COSTS	N/A	\$8 Per Year
EFFICIENCY	81 CFM/Watt	95 CFM/Watt



REV

3JVR44BSD

Brushed Steel Housing
 Silver/American Walnut Reversible Blades
 Frosted Acrylic Lens



3JVR44AGPD

Aged Pewter Housing
 Light Grey Weathered Oak Blades
 Frosted Acrylic Lens



3JVR44RZWD

Matte White Housing
 Matte White Blades
 Frosted Acrylic Lens



REV

3JVR44MBKD

Midnight Black Housing
 Midnight Black/American Walnut Reversible Blades
 Frosted Acrylic Lens

JOVIE 44 CEILING FANS



PRODUCT SHOWN: JOVIE 44 IN MATTE WHITE HOUSING WITH MATTE WHITE BLADES

JOVIE 44

DAMP

BLADES

(3) Blades (Included)
 12° Blade Pitch
 44" Blade Sweep

BLADE MATERIAL

Plywood

MOUNTING

Maximum Slope Angle with
 Included Hardware: 20°

INCLUDED CONTROLS

Wall Mount Control, 4-speed,
 Manual Reverse



COMPATIBLE ACCESSORIES

See Control Compatibility Chart (pg. 397)
 Slope Ceiling Canopy Kits MC95 & MC93 (pg. 400)

FAN SPECIFICATIONS

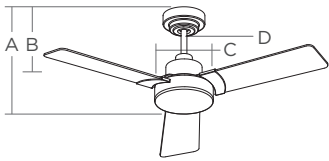

- A. Fixture Drop: 13.5"
- B. Blade Drop: 11.6"
- C. Housing Width: 8.3"
- D. Downrod: 6" (additional lengths pg. 401)

Motor Size: 153mm x 12mm

FTC ENERGY GUIDE

STANDARD	HIGH SPEED	WEIGHTED AVERAGE
ELECTRICITY	46 Watts	28 Watts
AIRFLOW	4034 CFM	2905 CFM
ENERGY COSTS	N/A	\$8 Per Year
EFFICIENCY	88 CFM/Watt	102 CFM/Watt



REV

3JVR44BS

Brushed Steel Housing
 Silver/American Walnut Reversible Blades



3JVR44AGP

Aged Pewter Housing
 Light Grey Weathered Oak Blades

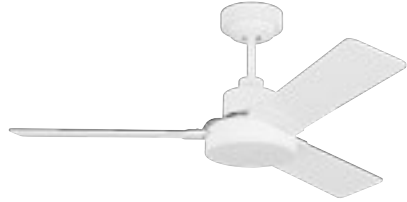

3JVR44RZW

Matte White Housing
 Matte White Blades



REV

3JVR44MBK

Midnight Black Housing
 Midnight Black/American Walnut Reversible Blades

ERA 52 LED

LED DAMP

BLADES

(3) Blades (Included)
13° Blade Pitch
52" Blade Sweep

BLADE MATERIAL

Plywood

LAMPING

Downlight: (2) 9W LED Bulbs
Light Output: 1600 Lumens Net
CCT: 3000K
CRI: 90+
MC362 Finishing Cap Available (pg. 402)

MOUNTING

Maximum Slope Angle with
Included Hardware: 18°

INCLUDED CONTROLS

3-Wire Wall Mount Control, 4-speed,
Dimmer and Manual Reverse



COMPATIBLE ACCESSORIES

See Control Compatibility Charts (pg. 397 & 399)

FAN SPECIFICATIONS

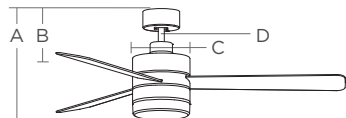

- A. Fixture Drop: 15"
- B. Blade Drop: 10.9"
- C. Housing Width: 8.1"
- D. Downrod: 4.5" (additional lengths pg. 401)

Motor Size: 153mm x 18mm

FTC ENERGY GUIDE

STANDARD	HIGH SPEED	WEIGHTED AVERAGE
ELECTRICITY	63 Watts	39 Watts
AIRFLOW	5657 CFM	3959 CFM
ENERGY COSTS	N/A	\$11 Per Year
EFFICIENCY	89 CFM/Watt	102 CFM/Watt



REV

3ERAR52BSD
Brushed Steel Housing
Silver/American Walnut Reversible Blades
Matte Opal Glass



3ERAR52AGP
Aged Pewter Housing
Light Grey Weathered Oak Blades
Matte Opal Glass



3ERAR52RZWD
Matte White Housing
Matte White Blades
Matte Opal Glass



REV

3ERAR52MBKD
Midnight Black Housing
Midnight Black/American Walnut Reversible Blades
Matte Opal Glass

ERA 52 HUGGER LED

LED WET

BLADES

(3) Blades (Included)
 13° Blade Pitch
 52" Blade Sweep

BLADE MATERIAL

Plywood

LAMPING

Downlight: (2) 9W LED Bulbs
 Light Output: 1600 Lumens Net
 CCT: 3000K
 CRI: 90+
 MC362 Finishing Cap Available (pg. 402)

MOUNTING

Flush Mount Only

INCLUDED CONTROLS

3-Wire Wall Mount Control, 4-speed, Dimmer and Manual Reverse



COMPATIBLE ACCESSORIES

See Control Compatibility Charts (pg. 397 & 399)

FAN SPECIFICATIONS

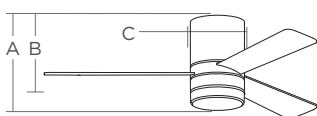

- A. Fixture Drop: 13"
- B. Blade Drop: 8.8"
- C. Housing Width: 8.1"

Motor Size: 153mm x 18mm

FTC ENERGY GUIDE

STANDARD	HIGH SPEED	WEIGHTED AVERAGE
ELECTRICITY	63 Watts	37 Watts
AIRFLOW	4784 CFM	3323 CFM
ENERGY COSTS	N/A	\$10 Per Year
EFFICIENCY	76 CFM/Watt	90 CFM/Watt



REV

3ERHR52BSD

Brushed Steel Housing
 Silver/American Walnut Reversible Blades
 Matte Opal Glass



3ERHR52AGPD

Aged Pewter Housing
 Light Grey Weathered Oak Blades
 Matte Opal Glass



3ERHR52RZWD

Matte White Housing
 Matte White Blades
 Matte Opal Glass



REV

3ERHR52MBKD

Midnight Black Housing
 Midnight Black/American Walnut Reversible Blades
 Matte Opal Glass

ERA 44 LED

LED DAMP

BLADES

(3) Blades (Included)
 13° Blade Pitch
 44" Blade Sweep

BLADE MATERIAL

Plywood

LAMPING

Downlight: (2) 9W LED Bulbs
 Light Output: 1600 Lumens Net
 CCT: 3000K
 CRI: 90+
 MC362 Finishing Cap Available (pg. 402)

MOUNTING

Maximum Slope Angle with
 Included Hardware: 18°

INCLUDED CONTROLS

3-Wire Wall Mount Control, 4-speed,
 Dimmer and Manual Reverse



COMPATIBLE ACCESSORIES

See Control Compatibility Charts (pg. 397 & 399)

FAN SPECIFICATIONS

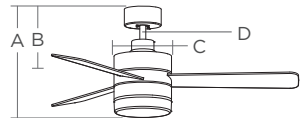

- A. Fixture Drop: 15"
- B. Blade Drop: 10.9"
- C. Housing Width: 8.1"
- D. Downrod: 4.5" (additional lengths pg. 401)

Motor Size: 153mm x 15mm

FTC ENERGY GUIDE

STANDARD	HIGH SPEED	WEIGHTED AVERAGE
ELECTRICITY	57 Watts	35 Watts
AIRFLOW	4808 CFM	3477 CFM
ENERGY COSTS	N/A	\$10 Per Year
EFFICIENCY	84 CFM/Watt	98 CFM/Watt



REV

3ERAR44BSD
 Brushed Steel Housing
 Silver/American Walnut Reversible Blades
 Matte Opal Glass



3ERAR44AGPD
 Aged Pewter Housing
 Light Grey Weathered Oak Blades
 Matte Opal Glass



3ERAR44RZWD
 Matte White Housing
 Matte White Blades
 Matte Opal Glass



REV

3ERAR44MBKD
 Midnight Black Housing
 Midnight Black/American Walnut Reversible Blades
 Matte Opal Glass

ERA 44 HUGGER LED

LED DAMP

BLADES

(3) Blades (Included)
 13° Blade Pitch
 44" Blade Sweep

BLADE MATERIAL

Plywood

LAMPING

Downlight: (2) 9W LED Bulbs
 Light Output: 1600 Lumens Net
 CCT: 3000K
 CRI: 90+
 MC362 Finishing Cap Available (pg. 402)

MOUNTING

Flush Mount Only

INCLUDED CONTROLS

3-Wire Wall Mount Control, 4-speed, Dimmer and Manual Reverse



COMPATIBLE ACCESSORIES

See Control Compatibility Charts (pg. 397 & 399)

FAN SPECIFICATIONS

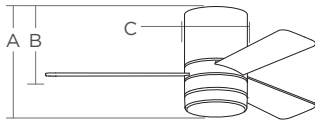

A. Fixture Drop: 13"
 B. Blade Drop: 8.8"
 C. Housing Width: 8.1"

Motor Size: 153mm x 15mm

FTC ENERGY GUIDE

STANDARD	HIGH SPEED	WEIGHTED AVERAGE
ELECTRICITY	56 Watts	33 Watts
AIRFLOW	4089 CFM	2851 CFM
ENERGY COSTS	N/A	\$9 Per Year
EFFICIENCY	73 CFM/Watt	86 CFM/Watt



REV

3ERHR44BSD

Brushed Steel Housing
 Silver/American Walnut Reversible Blades
 Matte Opal Glass



3ERHR44AGPD

Aged Pewter Housing
 Light Grey Weathered Oak Blades
 Matte Opal Glass



3ERHR44RZWD

Matte White Housing
 Matte White Blades
 Matte Opal Glass



REV

3ERHR44MBKD

Midnight Black Housing
 Midnight Black/American Walnut Reversible Blades
 Matte Opal Glass

TITUS 52 HUGGER LED CEILING FANS

TITUS 52 HUGGER LED

LED DAMP

BLADES

(3) Blades (Included)
13° Blade Pitch
52" Blade Sweep

BLADE MATERIAL

ABS

LAMPING

Integrated LED: 20W
Light Output: 800 Lumens Net
CCT: 3000K
CRI: 90+

MOUNTING

Flush Mount Only

INCLUDED CONTROLS

Handheld Remote,
4-speed, Dimmer and
Manual Reverse Switch



COMPATIBLE ACCESSORIES

See Control Compatibility Charts (pg. 397 & 399)

FAN SPECIFICATIONS

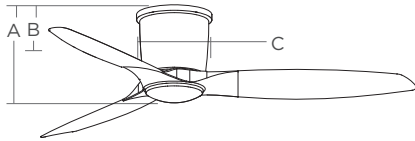

A. Fixture Drop: 9.8"
B. Blade Drop: 8.7"
C. Housing Width: 7.5"

Motor Size: 153mm x 18mm

FTC ENERGY GUIDE

STANDARD	HIGH SPEED	WEIGHTED AVERAGE
ELECTRICITY	54 Watts	34 Watts
AIRFLOW	5087 CFM	3692 CFM
ENERGY COSTS	N/A	\$9 Per Year
EFFICIENCY	95 CFM/Watt	109 CFM/Watt



3TTHR52SBD
Satin Brass Housing
Matte White ABS Blades
Frosted Acrylic Lens



3TTHR52BSD
Brushed Steel Housing
Silver ABS Blades
Frosted Acrylic Lens



3TTHR52MBKD
Midnight Black Housing
Midnight Black ABS Blades
Frosted Acrylic Lens



3TTHR52RZWD
Matte White Housing
Matte White ABS Blades
Frosted Acrylic Lens

TITUS 44 HUGGER LED

LED DAMP

BLADES

(3) Blades (Included)
 13° Blade Pitch
 44" Blade Sweep

BLADE MATERIAL

ABS

LAMPING

Integrated LED: 16W
 Light Output: 740 Lumens Net
 CCT: 3000K
 CRI: 90+

MOUNTING

Flush Mount Only

INCLUDED CONTROLS

Handheld Remote,
 4-speed, Dimmer and
 Manual Reverse Switch



COMPATIBLE ACCESSORIES

See Control Compatibility Charts (pg. 397 & 399)

FAN SPECIFICATIONS

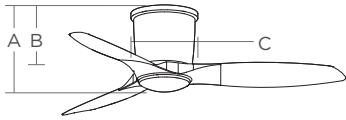

- A. Fixture Drop: 9.8"
- B. Blade Drop: 8.7"
- C. Housing Width: 7.5"

Motor Size: 153mm x 15mm

FTC ENERGY GUIDE

STANDARD	HIGH SPEED	WEIGHTED AVERAGE
ELECTRICITY	44 Watts	29 Watts
AIRFLOW	4081 CFM	3057 CFM
ENERGY COSTS	N/A	\$8 Per Year
EFFICIENCY	94 CFM/Watt	106 CFM/Watt



3TTHR44SBD
 Satin Brass Housing
 Matte White ABS Blades
 Frosted Acrylic Lens



3TTHR44BSD
 Brushed Steel Housing
 Silver ABS Blades
 Frosted Acrylic Lens



3TTHR44MBKD
 Midnight Black Housing
 Midnight Black ABS Blades
 Frosted Acrylic Lens



3TTHR44RZWD
 Matte White Housing
 Matte White ABS Blades
 Frosted Acrylic Lens

LOWDEN SMART 60 LED CEILING FANS

LOWDEN SMART 60 LED

EN★ LED DAMP DC SMART

BLADES

(5) Blades (Included)
12° Blade Pitch
60" Blade Sweep

BLADE MATERIAL

Plywood

LAMPING

Integrated LED: 20W
Light Output: 715 Lumens Net
CCT: 3000K
CRI: 90+

MOUNTING

Maximum Slope Angle with
Included Hardware: 30°

INCLUDED CONTROLS

Smart with Bond Home App (Download)
Hand-held Remote, 6-speed, Reverse



COMPATIBLE ACCESSORIES

Slope Ceiling Canopy Kits MC95 & MC93 (pg. 400)

FAN SPECIFICATIONS

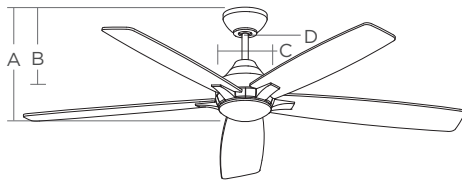

- A. Fixture Drop: 14.9"
- B. Blade Drop: 12.2"
- C. Housing Width: 7.8"
- D. Downrod: 6" (additional lengths pg. 401)

Motor Size: 178mm x 12mm

FTC ENERGY GUIDE

STANDARD	HIGH SPEED	WEIGHTED AVERAGE
ELECTRICITY	39 Watts	24 Watts
AIRFLOW	6729 CFM	4703 CFM
ENERGY COSTS	N/A	\$7 Per Year
EFFICIENCY	175 CFM/Watt	192 CFM/Watt



REV

5LWDSM60BSD
Brushed Steel Housing
Silver/American Walnut Reversible Blades
Frosted Acrylic Lens



REV

5LWDSM60BSLGD
Brushed Steel Housing
Silver/Light Grey Weathered Oak Reversible Blades
Frosted Acrylic Lens



REV

5LWDSM60MBKD
Midnight Black Housing
Midnight Black/American Walnut Reversible Blades
Frosted Acrylic Lens



5LWDSM60AGPD
Aged Pewter Housing
Light Grey Weathered Oak Blades
Frosted Acrylic Lens



5LWDSM60RZWD
Matte White Housing
Matte White Blades
Frosted Acrylic Lens

LOWDEN 52 LED

LED DAMP

BLADES

(5) Blades (Included)
12° Blade Pitch
52" Blade Sweep

BLADE MATERIAL

Plywood

LAMPING

Integrated LED: 20W
Light Output: 715 Lumens Net
CCT: 3000K
CRI: 90+

MOUNTING

Maximum Slope Angle with
Included Hardware: 30°

INCLUDED CONTROLS

Handheld Remote, 4-speed,
Dimmer and Manual Reverse



COMPATIBLE ACCESSORIES

See Control Compatibility Charts (pg. 397 & 399)
Slope Ceiling Canopy Kits MC95 & MC93 (pg. 400)

FAN SPECIFICATIONS

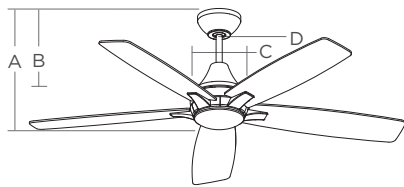

- A. Fixture Drop: 16"
- B. Blade Drop: 13.3"
- C. Housing Width: 7.8"
- D. Downrod: 6" (additional lengths pg. 401)

Motor Size: 153mm x 20mm

FTC ENERGY GUIDE

STANDARD	HIGH SPEED	WEIGHTED AVERAGE
ELECTRICITY	63 Watts	38 Watts
AIRFLOW	5229 CFM	3585 CFM
ENERGY COSTS	N/A	\$11 Per Year
EFFICIENCY	83 CFM/Watt	94 CFM/Watt



REV

5LWDR52BSD

Brushed Steel Housing
Silver/American Walnut Reversible Blades
Frosted Acrylic Lens



REV

5LWDR52BSLGD

Brushed Steel Housing
Silver/Light Grey Weathered Oak Reversible Blades
Frosted Acrylic Lens



REV

5LWDR52MBKD

Midnight Black Housing
Midnight Black/American Walnut Reversible Blades
Frosted Acrylic Lens



5LWDR52AGPD

Aged Pewter Housing
Light Grey Weathered Oak Blades
Frosted Acrylic Lens



5LWDR52RZWD

Matte White Housing
Matte White Blades
Frosted Acrylic Lens

ORBIS 52 LED CEILING FANS

ORBIS 52 LED

LED DAMP

BLADES

(3) Blades (Included)
12° Blade Pitch
52" Blade Sweep

BLADE MATERIAL

Plywood

LAMPING

Integrated LED: 20W
Light Output: 870 Lumens Net
CCT: 2700K, 3000K and 4000K
CRI: 90+

MOUNTING

Maximum Slope Angle with
Included Hardware: 20°

INCLUDED CONTROLS

3-Wire Wall Mount Control, 4-speed,
Dimmer and Manual Reverse



COMPATIBLE ACCESSORIES

See Control Compatibility Charts (pg. 397 & 399)

FAN SPECIFICATIONS

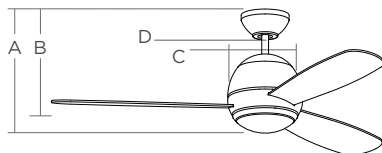

- A. Fixture Drop: 14.6"
- B. Blade Drop: 11.8"
- C. Housing Width: 9.1"
- D. Downrod: 4.5" (additional lengths pg. 401)

Motor Size: 153mm x 18mm

FTC ENERGY GUIDE

STANDARD	HIGH SPEED	WEIGHTED AVERAGE
ELECTRICITY	60 Watts	35 Watts
AIRFLOW	5295 CFM	3626 CFM
ENERGY COSTS	N/A	\$10 Per Year
EFFICIENCY	89 CFM/Watt	104 CFM/Watt

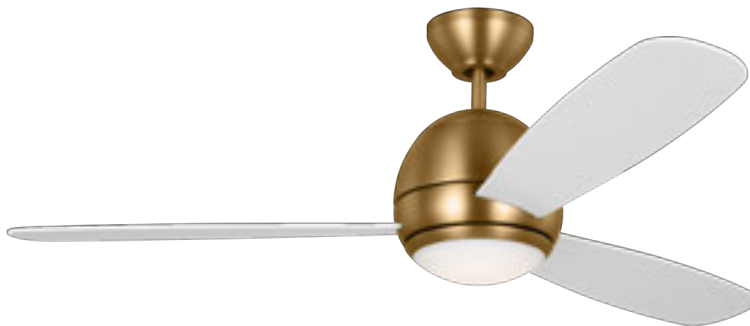

3OBSR52SBD
Satin Brass Housing
Matte White Blades
Frosted Acrylic Lens



REV

3OBSR52BSD
Brushed Steel Housing
Silver/American Walnut Reversible Blades
Frosted Acrylic Lens



REV

3OBSR52MBKD
Midnight Black Housing
Midnight Black/American Walnut Reversible Blades
Frosted Acrylic Lens



3OBSR52RZWD
Matte White Housing
Matte White Blades
Frosted Acrylic Lens

ORBIS 52 HUGGER LED

LED DAMP

BLADES

(3) Blades (Included)
 12° Blade Pitch
 52" Blade Sweep

BLADE MATERIAL

Plywood

LAMPING

Integrated LED: 20W
 Light Output: 870 Lumens Net
 CCT: 2700K, 3000K and 4000K
 CRI: 90+

MOUNTING

Flush Mount Only

INCLUDED CONTROLS

3-Wire Wall Mount Control, 4-speed,
 Dimmer and Manual Reverse



COMPATIBLE ACCESSORIES

See Control Compatibility Charts (pg. 397 & 399)

FAN SPECIFICATIONS

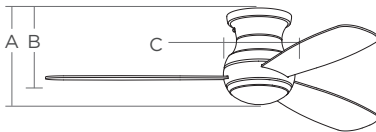

- A. Fixture Drop: 11"
- B. Blade Drop: 8.5"
- C. Housing Width: 8.7"

Motor Size: 153mm x 18mm

FTC ENERGY GUIDE

STANDARD	HIGH SPEED	WEIGHTED AVERAGE
ELECTRICITY	60 Watts	35 Watts
AIRFLOW	4825 CFM	3324 CFM
ENERGY COSTS	N/A	\$10 Per Year
EFFICIENCY	81 CFM/Watt	94 CFM/Watt

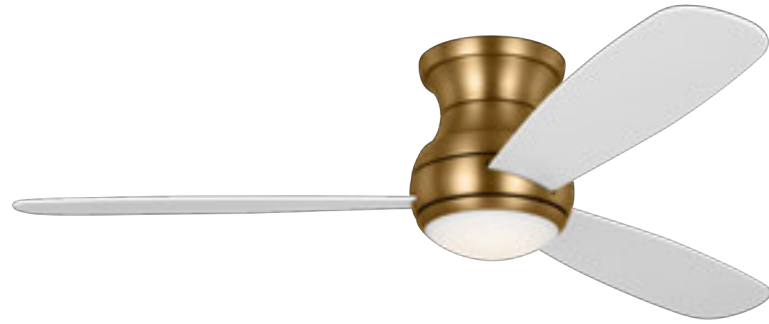

3OB52SBD
 Satin Brass Housing
 Matte White Blades
 Frosted Acrylic Lens



3OB52BSD
 Brushed Steel Housing
 Silver/American Walnut Reversible Blades
 Frosted Acrylic Lens



3OB52MBKD
 Midnight Black Housing
 Midnight Black/American Walnut Reversible Blades
 Frosted Acrylic Lens



3OB52RZWD
 Matte White Housing
 Matte White Blades
 Frosted Acrylic Lens

SYRUS 52 LED CEILING FANS

SYRUS 52 LED

LED

BLADES

(3) Blades (Included)
13° Blade Pitch
52" Blade Sweep

BLADE MATERIAL

Plywood

LAMPING

Downlight: (2) 9W LED Bulbs
Light Output: 1600 Lumens Net
CCT: 3000K
CRI: 90+

MOUNTING

Maximum Slope Angle with
Included Hardware: 30°

INCLUDED CONTROLS

3-speed Pull Chain Control,
Manual Reverse Switch



COMPATIBLE ACCESSORIES

See Control Compatibility Charts (pg. 397 & 399)
Slope Ceiling Canopy Kits MC95 & MC93 (pg. 400)

FAN SPECIFICATIONS

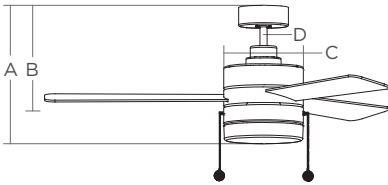

- A. Fixture Drop: 15.9"
- B. Blade Drop: 11.4"
- C. Housing Width: 9.4"
- D. Downrod: 4.5" (additional lengths pg. 401)

Motor Size: 153mm x 18mm

FTC ENERGY GUIDE

STANDARD	HIGH SPEED	WEIGHTED AVERAGE
ELECTRICITY	62 Watts	40 Watts
AIRFLOW	5336 CFM	3944 CFM
ENERGY COSTS	N/A	\$11 Per Year
EFFICIENCY	86 CFM/Watt	99 CFM/Watt



REV

3SY52OZD

Oil Rubbed Bronze Housing
Oil Rubbed Bronze/American Walnut Reversible Blades
Frosted Acrylic Lens



REV

3SY52BSD

Brushed Steel Housing
Silver/American Walnut Reversible Blades
Frosted Acrylic Lens



REV

3SY52MBKD

Midnight Black Housing
Midnight Black/American Walnut Reversible Blades
Frosted Acrylic Lens



3SY52RZWD

Matte White Housing
Matte White Blades
Frosted Acrylic Lens

DISCUS SMART 52 LED

EN★ LED DC SMART

BLADES

(5) Blades (Included)
 12° Blade Pitch
 52" Blade Sweep

BLADE MATERIAL

Plywood

LAMPING

Integrated LED: 20W
 Light Output: 1060 Lumens Net
 CCT: 3000K
 CRI: 90+
 Optional MC360 Finishing Cap Available (pg. 402)

MOUNTING

Maximum Slope Angle with
 Included Hardware: 30°

INCLUDED CONTROLS

Smart with Bond Home App (Download)
 Hand-held Remote, 6-speed, Reverse



FAN SPECIFICATIONS

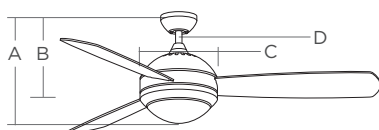

- A. Fixture Drop: 15.1"
- B. Blade Drop: 10.6"
- C. Housing Width: 11.1"
- D. Downrod: 4.5" (additional lengths pg. 401)

Motor Size: 150mm x 16mm

FTC ENERGY GUIDE

STANDARD	HIGH SPEED	WEIGHTED AVERAGE
ELECTRICITY	36 Watts	25 Watts
AIRFLOW	6263 CFM	4310 CFM
ENERGY COSTS	N/A	\$7 Per Year
EFFICIENCY	174 CFM/Watt	171 CFM/Watt



REV

5DISM52BSD

Brushed Steel Housing
 Silver/American Walnut Reversible Blades
 Matte Opal Glass



5DISM52AGPD

Aged Pewter Housing
 Light Grey Weathered Oak Blades
 Matte Opal Glass



5DISM52MBKD

Midnight Black Housing
 Midnight Black Blades
 Matte Opal Glass



5DISM52RZWD

Matte White Housing
 Matte White Blades
 Matte Opal Glass

DISCUS ORNATE 52 LED CEILING FANS



PRODUCT SHOWN: DISCUS ORNATE 52 LED IN MATTE BLACK HOUSING WITH MATTE BLACK BLADES AND MATTE OPAL GLASS

DISCUS ORNATE 52 LED

LED

BLADES

(5) Blades (Included)
 12° Blade Pitch
 52" Blade Sweep

BLADE MATERIAL

Plywood

LAMPING

Integrated LED: 20W
 Light Output: 715 Lumens Net
 CCT: 2700K
 CRI: 90+
 Optional MC360 Finishing Cap Available (pg. 402)

MOUNTING

Maximum Slope Angle with
 Included Hardware: 30°

INCLUDED CONTROLS

Pull Chain Operation, 3-speed,
 Manual Reverse Switch



COMPATIBLE ACCESSORIES

Slope Ceiling Canopy Kits MC95 & MC93 (pg. 400)
 See Control Compatibility Charts (pg. 397 & 399)

FAN SPECIFICATIONS

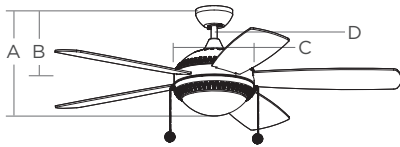

- A. Fixture Drop: 15.1"
- B. Blade Drop: 10.6"
- C. Housing Width: 11.1"
- D. Downrod: 4.5" (additional lengths pg. 401)

Motor Size: 153mm x 18mm

FTC ENERGY GUIDE

STANDARD	HIGH SPEED	WEIGHTED AVERAGE
ELECTRICITY	65 Watts	41 Watts
AIRFLOW	4758 CFM	3415 CFM
ENERGY COSTS	N/A	\$11 Per Year
EFFICIENCY	73 CFM/Watt	83 CFM/Watt



REV

5DIO52RBD

Roman Bronze Housing
 Bronze/American Walnut Reversible Blades
 Matte Opal Glass



5DIO52AGPD

Aged Pewter Housing
 Light Grey Weathered Oak Blades
 Matte Opal Glass



5DIO52BKD

Matte Black Housing
 Matte Black Blades
 Matte Opal Glass

DISCUS CLASSIC 52 LED CEILING FANS

DISCUS CLASSIC 52 LED

LED

BLADES

(5) Blades (Included)
12° Blade Pitch
52" Blade Sweep

BLADE MATERIAL

Plywood

LAMPING

Integrated LED: 20W
Light Output: 1060 Lumens Net
CCT: 3000K
CRI: 90+
Optional MC360 Finishing Cap Available (pg. 402)

MOUNTING

Maximum Slope Angle with
Included Hardware: 30°
Dual Mount allowing downrod and flush mounting

INCLUDED CONTROLS

Pull Chain Operation, 3-speed,
Manual Reverse Switch



COMPATIBLE ACCESSORIES

Slope Ceiling Canopy Kits MC95 & MC93 (pg. 400)
See Control Compatibility Charts (pg. 397 & 399)

FAN SPECIFICATIONS

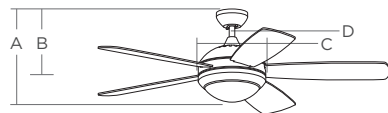

A. Fixture Drop: 15.1"
B. Blade Drop: 10.6"
C. Housing Width: 11.1"
D. Downrod: 4.5" (additional lengths pg. 401)

Motor Size: 153mm x 18mm

FTC ENERGY GUIDE

STANDARD	HIGH SPEED	WEIGHTED AVERAGE
ELECTRICITY	65 Watts	41 Watts
AIRFLOW	4758 CFM	3415 CFM
ENERGY COSTS	N/A	\$11 Per Year
EFFICIENCY	73 CFM/Watt	83 CFM/Watt

FTC ENERGY GUIDE

HUGGER	HIGH SPEED	WEIGHTED AVERAGE
ELECTRICITY	65 Watts	41 Watts
AIRFLOW	3217 CFM	2164 CFM
ENERGY COSTS	N/A	\$12 Per Year
EFFICIENCY	49 CFM/Watt	53 CFM/Watt



REV

5DIC52RBD-V1
Roman Bronze Housing
Bronze/American Walnut Reversible Blades
Matte Opal Glass



REV

5DIC52BSD-V1
Brushed Steel Housing
Silver/American Walnut Reversible Blades
Matte Opal Glass



REV

5DIC52PND-V1
Polished Nickel Housing
Silver/American Walnut Reversible Blades
Matte Opal Glass



5DIC52AGPD-V1

Aged Pewter Housing
Light Grey Weathered Oak Blades
Matte Opal Glass



5DIC52BKD-V1

Matte Black Housing
Matte Black Blades
Matte Opal Glass



5DIC52WHD-V1

White Housing
White Blades
Matte Opal Glass

DISCUS CLASSIC 44 LED

LED

BLADES

(5) Blades (Included)
 12° Blade Pitch
 44" Blade Sweep

BLADE MATERIAL

Plywood

LAMPING

Integrated LED: 20W
 Light Output: 1060 Lumens Net
 CCT: 3000K
 CRI: 90+
 Optional MC360 Finishing Cap Available (pg. 402)

MOUNTING

Maximum Slope Angle with
 Included Hardware: 30°
 Dual Mount allowing downrod and flush mounting

INCLUDED CONTROLS

Pull Chain Operation, 3-speed,
 Manual Reverse Switch



COMPATIBLE ACCESSORIES

Slope Ceiling Canopy Kits MC95 & MC93 (pg. 400)
 See Control Compatibility Charts (pg. 397 & 399)

FAN SPECIFICATIONS

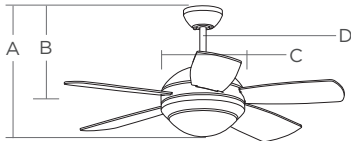

- A. Fixture Drop: 15.1"
- B. Blade Drop: 10.6"
- C. Housing Width: 11.1"
- D. Downrod: 4.5" (additional lengths pg. 401)

Motor Size: 153mm x 18mm

FTC ENERGY GUIDE

STANDARD	HIGH SPEED	WEIGHTED AVERAGE
ELECTRICITY	58 Watts	37 Watts
AIRFLOW	3954 CFM	2850 CFM
ENERGY COSTS	N/A	\$10 Per Year
EFFICIENCY	68 CFM/Watt	77 CFM/Watt

FTC ENERGY GUIDE

HUGGER	HIGH SPEED	WEIGHTED AVERAGE
ELECTRICITY	58 Watts	37 Watts
AIRFLOW	3020 CFM	1970 CFM
ENERGY COSTS	N/A	\$10 Per Year
EFFICIENCY	52 CFM/Watt	53 CFM/Watt



REV

5DIC44RBD-V1
 Roman Bronze Housing
 Bronze/American Walnut Reversible Blades
 Matte Opal Glass



REV

5DIC44BSD-V1
 Brushed Steel Housing
 Silver/American Walnut Reversible Blades
 Matte Opal Glass



REV

5DIC44PND-V1
 Polished Nickel Housing
 Silver/American Walnut Reversible Blades
 Matte Opal Glass



5DIC44AGPD-V1
 Aged Pewter Housing
 Light Grey Weathered Oak Blades
 Matte Opal Glass



5DIC44BKD-V1
 Matte Black Housing
 Matte Black Blades
 Matte Opal Glass



5DIC44WHD-V1
 White Housing
 White Blades
 Matte Opal Glass

COLONY 60 LED CEILING FANS

COLONY 60 LED

LED DAMP

BLADES

(5) Blades (Included)
12° Blade Pitch
60" Blade Sweep

BLADE MATERIAL

Plywood

LAMPING

Downlight: (2) 9W LED Bulbs
Light Output: 1600 Lumens Net
CCT: 3000K
CRI: 90+

MOUNTING

Maximum Slope Angle with
Included Hardware: 30°
Dual Mount allowing downrod and flush mounting

INCLUDED CONTROLS

Pull Chain Operation, 3-speed,
Manual Reverse Switch



COMPATIBLE ACCESSORIES

Slope Ceiling Canopy Kits MC95 & MC93 (pg. 400)
See Control Compatibility Charts (pg. 397 & 399)

FAN SPECIFICATIONS

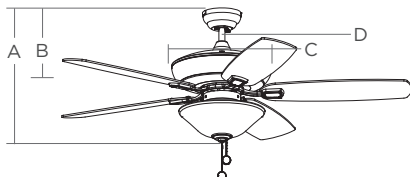

A. Fixture Drop: 18.5"
B. Blade Drop: 11.5"
C. Housing Width: 13.8"
D. Downrod: 4.5" (additional lengths pg. 401)

Motor Size: 188mm x 20mm

FTC ENERGY GUIDE

STANDARD	HIGH SPEED	WEIGHTED AVERAGE
ELECTRICITY	72 Watts	47 Watts
AIRFLOW	5348 CFM	3963 CFM
ENERGY COSTS	N/A	\$13 Per Year
EFFICIENCY	74 CFM/Watt	84 CFM/Watt

FTC ENERGY GUIDE

HUGGER	HIGH SPEED	WEIGHTED AVERAGE
ELECTRICITY	72 Watts	47 Watts
AIRFLOW	4581 CFM	3356 CFM
ENERGY COSTS	N/A	\$13 Per Year
EFFICIENCY	63 CFM/Watt	71 CFM/Watt



REV

5CSM60RBD-V1
Roman Bronze Housing
Bronze/American Walnut Reversible Blades
Matte White Glass



REV

5CSM60BSD-V1
Brushed Steel Housing
Silver/American Walnut Reversible Blades
Matte White Glass



REV

5CSM60MBKD-V1
Midnight Black Housing
Midnight Black/American Walnut Reversible Blades
Matte White Glass



5CSM60AGPD-V1

Aged Pewter Housing
Light Grey Weathered Oak Blades
Matte White Glass



5CSM60RZWD-V1

Matte White Housing
Matte White Blades
Matte White Glass

COLONY 60

DAMP

BLADES

(5) Blades (Included)
 12° Blade Pitch
 60" Blade Sweep

BLADE MATERIAL

Plywood

MOUNTING

Maximum Slope Angle with
 Included Hardware: 30°
 Dual Mount allowing downrod and flush mounting

INCLUDED CONTROLS

Pull Chain Operation, 3-speed,
 Manual Reverse Switch



COMPATIBLE ACCESSORIES

Slope Ceiling Canopy Kits MC95 & MC93 (pg. 400)
 Light Kit Adaptable (pg. 403)
 See Control Compatibility Charts (pg. 397 & 399)

FAN SPECIFICATIONS

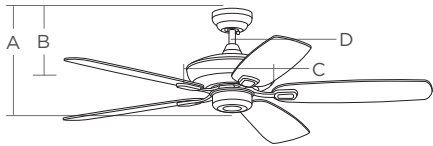

- A. Fixture Drop: 13.5"
- B. Blade Drop: 11.5"
- C. Housing Width: 13.8"
- D. Downrod: 4.5" (additional lengths pg. 401)

Motor Size: 188mm x 20mm

FTC ENERGY GUIDE

STANDARD	HIGH SPEED	WEIGHTED AVERAGE
ELECTRICITY	72 Watts	47 Watts
AIRFLOW	5489 CFM	4096 CFM
ENERGY COSTS	N/A	\$13 Per Year
EFFICIENCY	76 CFM/Watt	87 CFM/Watt

FTC ENERGY GUIDE

HUGGER	HIGH SPEED	WEIGHTED AVERAGE
ELECTRICITY	72 Watts	47 Watts
AIRFLOW	4877 CFM	3633 CFM
ENERGY COSTS	N/A	\$13 Per Year
EFFICIENCY	68 CFM/Watt	77 CFM/Watt



5CSM60RB
 Roman Bronze Housing
 Bronze/American Walnut Reversible Blades



5CSM60BS
 Brushed Steel Housing
 Silver/American Walnut Reversible Blades



5CSM60MBK
 Midnight Black Housing
 Midnight Black/American Walnut Reversible Blades



5CSM60AGP
 Aged Pewter Housing
 Light Grey Weathered Oak Blades



5CSM60RZW
 Matte White Housing
 Matte White Blades

COLONY 52 LED CEILING FANS

COLONY 52 LED

LED DAMP

BLADES

(5) Blades (Included)
12° Blade Pitch
52" Blade Sweep

BLADE MATERIAL

Plywood

LAMPING

Downlight: (2) 9W LED Bulbs
Light Output: 1600 Lumens Net
CCT: 3000K
CRI: 90+

MOUNTING

Maximum Slope Angle with
Included Hardware: 30°
Dual Mount allowing downrod and flush mounting

INCLUDED CONTROLS

Pull Chain Operation, 3-speed,
Manual Reverse Switch



COMPATIBLE ACCESSORIES

Slope Ceiling Canopy Kits MC95 & MC93 (pg. 400)
See Control Compatibility Charts (pg. 397 & 399)

FAN SPECIFICATIONS

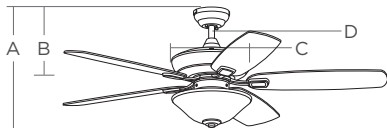

- A. Fixture Drop: 17.7"
- B. Blade Drop: 11.3"
- C. Housing Width: 11.8"
- D. Downrod: 4.5" (additional lengths pg. 401)

Motor Size: 153mm x 18mm

FTC ENERGY GUIDE

STANDARD	HIGH SPEED	WEIGHTED AVERAGE
ELECTRICITY	58 Watts	37 Watts
AIRFLOW	4224 CFM	3164 CFM
ENERGY COSTS	N/A	\$10 Per Year
EFFICIENCY	73 CFM/Watt	85 CFM/Watt

FTC ENERGY GUIDE

HUGGER	HIGH SPEED	WEIGHTED AVERAGE
ELECTRICITY	58 Watts	37 Watts
AIRFLOW	2675 CFM	1900 CFM
ENERGY COSTS	N/A	\$10 Per Year
EFFICIENCY	46 CFM/Watt	51 CFM/Watt



REV

5COM52RBD-V1
Roman Bronze Housing
Bronze/American Walnut Reversible Blades
Matte White Glass



REV

5COM52BSD-V1
Brushed Steel Housing
Silver/American Walnut Reversible Blades
Matte White Glass



REV

5COM52MBKD-V1
Midnight Black Housing
Midnight Black/American Walnut Reversible Blades
Matte White Glass



5COM52AGPD-V1

Aged Pewter Housing
Light Grey Weathered Oak Blades
Matte White Glass



5COM52RZWD-V1

Matte White Housing
Matte White Blades
Matte White Glass

COLONY 52

DAMP

BLADES

(5) Blades (Included)
 12° Blade Pitch
 52" Blade Sweep

BLADE MATERIAL

Plywood

MOUNTING

Maximum Slope Angle with
 Included Hardware: 30°
 Dual Mount allowing downrod and flush mounting

INCLUDED CONTROLS

Pull Chain Operation, 3-speed,
 Manual Reverse Switch



COMPATIBLE ACCESSORIES

Slope Ceiling Canopy Kits MC95 & MC93 (pg. 400)
 Light Kit Adaptable (pg. 403)
 See Control Compatibility Charts (pg. 397 & 399)

FAN SPECIFICATIONS

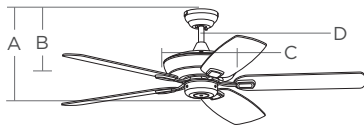

- A. Fixture Drop: 12.8"
- B. Blade Drop: 11.3"
- C. Housing Width: 11.8"
- D. Downrod: 4.5" (additional lengths pg. 401)

Motor Size: 153mm x 18mm

FTC ENERGY GUIDE

STANDARD	HIGH SPEED	WEIGHTED AVERAGE
ELECTRICITY	58 Watts	36 Watts
AIRFLOW	4201 CFM	3475 CFM
ENERGY COSTS	N/A	\$10 Per Year
EFFICIENCY	72 CFM/Watt	97 CFM/Watt

FTC ENERGY GUIDE

HUGGER	HIGH SPEED	WEIGHTED AVERAGE
ELECTRICITY	58 Watts	37 Watts
AIRFLOW	2375 CFM	1748 CFM
ENERGY COSTS	N/A	\$10 Per Year
EFFICIENCY	41 CFM/Watt	47 CFM/Watt



REV

5COM52RB

Roman Bronze Housing
 Bronze/American Walnut Reversible Blades



REV

5COM52BS

Brushed Steel Housing
 Silver/American Walnut Reversible Blades



REV

5COM52MBK

Midnight Black Housing
 Midnight Black/American Walnut Reversible Blades



5COM52AGP

Aged Pewter Housing with
 Light Grey Weathered Oak Blades



5COM52RZW

Matte White Housing
 Matte White Blades

LINDEN DC 52 LED CEILING FANS

LINDEN DC 52 LED

EN★ LED DC

BLADES

(5) Blades (Included)
12° Blade Pitch
52" Blade Sweep

BLADE MATERIAL

MDF

LAMPING

Downlight: (2) 9W LED Bulbs
Light Output: 1600 Lumens Net
CCT: 3000K
CRI: 90+

MOUNTING

Maximum Slope Angle with
Included Hardware: 30°
Dual Mount allowing downrod and flush mounting

INCLUDED CONTROLS

Pull Chain Operation, 3-speed,
Manual Reverse Switch



COMPATIBLE ACCESSORIES

Slope Ceiling Canopy Kits MC95 & MC93 (pg. 400)
Light Kit Adaptable (pg. 403)

FAN SPECIFICATIONS

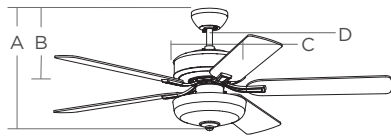

A. Fixture Drop: 17.8"
B. Blade Drop: 11.4"
C. Housing Width: 10.3"
D. Downrod: 4.5" (additional lengths pg. 401)

Motor Size: 150mm x 16mm

FTC ENERGY GUIDE

STANDARD	HIGH SPEED	WEIGHTED AVERAGE
ELECTRICITY	29 Watts	18 Watts
AIRFLOW	5154 CFM	3746 CFM
ENERGY COSTS	N/A	\$5 Per Year
EFFICIENCY	175 CFM/Watt	206 CFM/Watt

FTC ENERGY GUIDE

HUGGER	HIGH SPEED	WEIGHTED AVERAGE
ELECTRICITY	31 Watts	18 Watts
AIRFLOW	4201 CFM	3116 CFM
ENERGY COSTS	N/A	\$5 Per Year
EFFICIENCY	135 CFM/Watt	172 CFM/Watt



REV

5LDDC52BZD
Bronze Housing
Bronze/American Walnut Reversible Blades
Matte White Glass



REV

5LDDC52BSD
Brushed Steel Housing
Silver/American Walnut Reversible Blades
Matte White Glass



REV

5LDDC52MBKD
Midnight Black Housing
Midnight Black/American Walnut Reversible Blades
Matte White Glass



5LDDC52RZWD

Matte White Housing
Matte White Blades
Matte White Glass

LINDEN 52 LED

LED

BLADES

(5) Blades (Included)
 12° Blade Pitch
 52" Blade Sweep

BLADE MATERIAL

MDF

LAMPING

Downlight: (2) 9W LED Bulbs
 Light Output: 1600 Lumens Net
 CCT: 3000K
 CRI: 90+

MOUNTING

Maximum Slope Angle with
 Included Hardware: 30°
 Dual Mount allowing downrod and flush mounting

INCLUDED CONTROLS

Pull Chain Operation, 3-speed,
 Manual Reverse Switch



COMPATIBLE ACCESSORIES

Slope Ceiling Canopy Kits MC95 & MC93 (pg. 400)

FAN SPECIFICATIONS

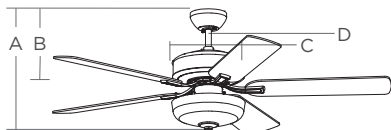

- A. Fixture Drop: 17.2"
- B. Blade Drop: 11.4"
- C. Housing Width: 10.3"
- D. Downrod: 4.5" (additional lengths pg. 401)

Motor Size: 153mm x 15mm

FTC ENERGY GUIDE

STANDARD	HIGH SPEED	WEIGHTED AVERAGE
ELECTRICITY	61 Watts	39 Watts
AIRFLOW	4520 CFM	3424 CFM
ENERGY COSTS	N/A	\$11 Per Year
EFFICIENCY	75 CFM/Watt	88 CFM/Watt

FTC ENERGY GUIDE

HUGGER	HIGH SPEED	WEIGHTED AVERAGE
ELECTRICITY	61 Watts	39 Watts
AIRFLOW	3785 CFM	2815 CFM
ENERGY COSTS	N/A	\$11 Per Year
EFFICIENCY	62 CFM/Watt	72 CFM/Watt



REV

5LD52BZD

Bronze Housing
 Bronze/American Walnut Reversible Blades
 Matte White Glass



REV

5LD52BSD

Brushed Steel Housing
 Silver/American Walnut Reversible Blades
 Matte White Glass



REV

5LD52MBKD

Midnight Black Housing
 Midnight Black/American Walnut Reversible Blades
 Matte White Glass



5LD52RZWD

Matte White Housing
 Matte White ABS Blades
 Matte White Glass

LINDEN 52 LED 3 CEILING FANS

LINDEN 52 LED 3

BLADES

(5) Blades (Included)
12° Blade Pitch
52" Blade Sweep

BLADE MATERIAL

MDF

LAMPING

Downlight: (3) 9W LED Bulbs
Light Output: 2400 Lumens Net
CCT: 3000K
CRI: 90+

MOUNTING

Maximum Slope Angle with
Included Hardware: 30°

INCLUDED CONTROLS

Pull Chain Operation, 3-speed,
Manual Reverse Switch



COMPATIBLE ACCESSORIES

Slope Ceiling Canopy Kits MC95 & MC93 (pg. 400)

FAN SPECIFICATIONS

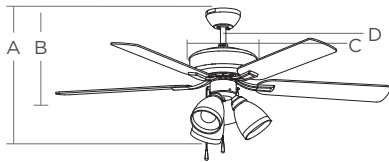

- A. Fixture Drop: 19.3"
- B. Blade Drop: 11.6"
- C. Housing Width: 10.3"
- D. Downrod: 4.5" (additional lengths pg. 401)

Motor Size: 153mm x 12mm

FTC ENERGY GUIDE

STANDARD	HIGH SPEED	WEIGHTED AVERAGE
ELECTRICITY	58 Watts	38 Watts
AIRFLOW	4917 CFM	3830 CFM
ENERGY COSTS	N/A	\$11 Per Year
EFFICIENCY	85 CFM/Watt	102 CFM/Watt

FTC ENERGY GUIDE

HUGGER	HIGH SPEED	WEIGHTED AVERAGE
ELECTRICITY	58 Watts	38 Watts
AIRFLOW	3954 CFM	3082 CFM
ENERGY COSTS	N/A	\$11 Per Year
EFFICIENCY	69 CFM/Watt	82 CFM/Watt



REV

5LD52BSF
Brushed Steel Housing
Silver/American Walnut Reversible Blades
Frosted White Glass



REV

5LD52BZF
Bronze Housing
Bronze/American Walnut Reversible Blades
Frosted White Glass



REV

5LD52MBKF
Midnight Black Housing
Midnight Black/American Walnut Reversible Blades
Frosted White Glass



REV

5LD52RZWF
Matte White Housing
Matte White Blades
Frosted White Glass

LINDEN 52

BLADES

(5) Blades (Included)
 12° Blade Pitch
 52" Blade Sweep

BLADE MATERIAL

MDF

MOUNTING

Maximum Slope Angle with
 Included Hardware: 30°
 Dual Mount allowing downrod and flush mounting

INCLUDED CONTROLS

Pull Chain Operation, 3-speed,
 Manual Reverse Switch



COMPATIBLE ACCESSORIES

Slope Ceiling Canopy Kits MC95 & MC93 (pg. 400)

FAN SPECIFICATIONS

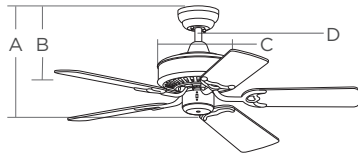

- A. Fixture Drop: 13.3"
- B. Blade Drop: 11.4"
- C. Housing Width: 10.3"
- D. Downrod: 4.5" (additional lengths pg. 401)

Motor Size: 153mm x 12mm

FTC ENERGY GUIDE

STANDARD	HIGH SPEED	WEIGHTED AVERAGE
ELECTRICITY	61 Watts	39 Watts
AIRFLOW	4326 CFM	3291 CFM
ENERGY COSTS	N/A	\$11 Per Year
EFFICIENCY	71 CFM/Watt	84 CFM/Watt

FTC ENERGY GUIDE

HUGGER	HIGH SPEED	WEIGHTED AVERAGE
ELECTRICITY	61 Watts	39 Watts
AIRFLOW	3715 CFM	2783 CFM
ENERGY COSTS	N/A	\$11 Per Year
EFFICIENCY	61 CFM/Watt	71 CFM/Watt



REV

5LD52BZ

Bronze Housing
 Bronze/American Walnut Reversible Blades



REV

5LD52BS

Brushed Steel Housing
 Silver/American Walnut Reversible Blades



REV

5LD52MBK

Midnight Black Housing
 Midnight Black/American Walnut Reversible Blades



5LD52RZW

Matte White Housing
 Matte White Blades

LINDEN 48 LED CEILING FANS

LINDEN 48 LED

LED

BLADES

(3) Blades (Included)
12° Blade Pitch
48" Blade Sweep

BLADE MATERIAL

MDF

LAMPING

Downlight: (2) 9W LED Bulbs
Light Output: 1600 Lumens Net
CCT: 3000K
CRI: 90+

MOUNTING

Maximum Slope Angle with
Included Hardware: 30°

INCLUDED CONTROLS

Pull Chain Operation, 3-speed,
Manual Reverse Switch



COMPATIBLE ACCESSORIES

Slope Ceiling Canopy Kits MC95 & MC93 (pg. 400)

FAN SPECIFICATIONS

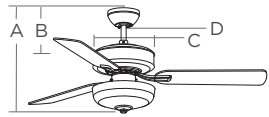

- A. Fixture Drop: 17.2"
- B. Blade Drop: 11.4"
- C. Housing Width: 10.3"
- D. Downrod: 4.5" (additional lengths pg. 401)

Motor Size: 153mm x 10mm

FTC ENERGY GUIDE

STANDARD	HIGH SPEED	WEIGHTED AVERAGE
ELECTRICITY	55 Watts	35 Watts
AIRFLOW	4055 CFM	2871 CFM
ENERGY COSTS	N/A	\$10 Per Year
EFFICIENCY	73 CFM/Watt	83 CFM/Watt



REV

3LD48BZD

Bronze Housing
Bronze/American Walnut Reversible Blades
Matte White Glass



REV

3LD48BSD

Brushed Steel Housing
Silver/American Walnut Reversible Blades
Matte White Glass



REV

3LD48MBKD

Midnight Black Housing
Midnight Black/American Walnut Reversible Blades
Matte White Glass



3LD48RZWD

Matte White Housing
Matte White Blades
Matte White Glass

LINDEN 48

BLADES

(3) Blades (Included)

12° Blade Pitch

48" Blade Sweep

BLADE MATERIAL

MDF

MOUNTING

Maximum Slope Angle with

Included Hardware: 30°

INCLUDED CONTROLS

Pull Chain Operation, 3-speed,

Manual Reverse Switch



COMPATIBLE ACCESSORIES

Slope Ceiling Canopy Kits MC95 & MC93 (pg. 400)

FAN SPECIFICATIONS

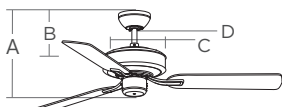

A. Fixture Drop: 13.3"

B. Blade Drop: 11.4"

C. Housing Width: 10.3"

D. Downrod: 4.5" (additional lengths pg. 401)

Motor Size: 153mm x 10mm

FTC ENERGY GUIDE

STANDARD	HIGH SPEED	WEIGHTED AVERAGE
ELECTRICITY	55 Watts	35 Watts
AIRFLOW	4064 CFM	2895 CFM
ENERGY COSTS	N/A	\$10 Per Year
EFFICIENCY	74 CFM/Watt	84 CFM/Watt



REV

3LD48BZ

Bronze Housing

Bronze/American Walnut Reversible Blades



REV

3LD48BS

Brushed Steel Housing

Silver/American Walnut Reversible Blades



REV

3LD48MBK

Midnight Black Housing

Midnight Black/American Walnut Reversible Blades



3LD48RZW

Matte White Housing

Matte White Blades

JOVIE OUTDOOR 58 LED CEILING FANS

JOVIE OUTDOOR 58 LED

EN★ LED WET DC

BLADES

(3) Blades (Included)
 12° Blade Pitch
 58" Blade Sweep

BLADE MATERIAL

ABS

LAMPING

Integrated LED: 20W
 Light Output: 960 Lumens Net
 CCT: 2700K, 3000K and 4000
 CRI: 90+

MOUNTING

Maximum Slope Angle with
 Included Hardware: 20°

INCLUDED CONTROLS

Handheld Remote, 6-speed,
 Reverse and Dimmer



COMPATIBLE ACCESSORIES

Wall Control ESSWC-10 (pg. 398)
 Slope Ceiling Canopy Kits MC95 & MC93 (pg. 400)

FAN SPECIFICATIONS

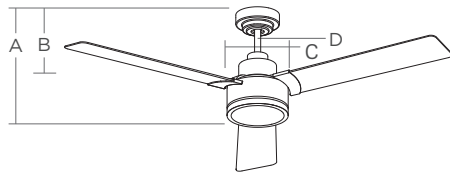

- A. Fixture Drop: 14.7"
- B. Blade Drop: 11.7"
- C. Housing Width: 8.3"
- D. Downrod: 6" (additional lengths pg. 401)

Motor Size: 178mm x 12mm

FTC ENERGY GUIDE

STANDARD	HIGH SPEED	WEIGHTED AVERAGE
ELECTRICITY	20 Watts	14 Watts
AIRFLOW	5648 CFM	4062 CFM
ENERGY COSTS	N/A	\$4 Per Year
EFFICIENCY	288 CFM/Watt	282 CFM/Watt



3JVR58AGPD
 Aged Pewter Housing
 Light Grey Weathered Oak ABS Blades
 Frosted Acrylic Lens



3JVR58MBKD
 Midnight Black Housing
 Midnight Black ABS Blades
 Frosted Acrylic Lens



3JVR58RZWD
 Matte White Housing
 Matte White ABS Blades
 Frosted Acrylic Lens

JOVIE OUTDOOR 58

EN★ WET DC

BLADES

(3) Blades (Included)
 12° Blade Pitch
 58" Blade Sweep

BLADE MATERIAL

ABS

MOUNTING

Maximum Slope Angle with
 Included Hardware: 20°

INCLUDED CONTROLS

Handheld Remote,
 6-speed, Reverse



COMPATIBLE ACCESSORIES

Wall Control ESSWC-10 (pg. 398)
 Slope Ceiling Canopy Kits MC95 & MC93 (pg. 400)

FAN SPECIFICATIONS

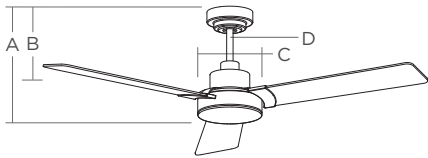

- A. Fixture Drop: 13.5"
- B. Blade Drop: 11.6"
- C. Housing Width: 8.3"
- D. Downrod: 6" (additional lengths pg. 401)

Motor Size: 178mm x 12mm

FTC ENERGY GUIDE

STANDARD	HIGH SPEED	WEIGHTED AVERAGE
ELECTRICITY	18 Watts	14 Watts
AIRFLOW	5551 CFM	3968 CFM
ENERGY COSTS	N/A	\$4 Per Year
EFFICIENCY	315 CFM/Watt	288 CFM/Watt



3JVR58AGP
 Aged Pewter Housing
 Light Grey Weathered Oak ABS Blades



3JVR58MBK
 Midnight Black Housing
 Midnight Black ABS Blades

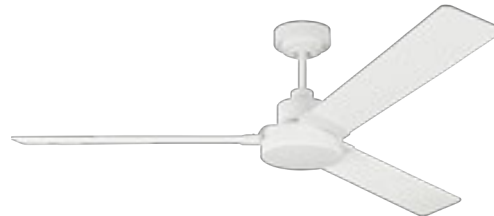

3JVR58RZW
 Matte White Housing
 Matte White ABS Blades

LINDEN OUTDOOR 52 LED CEILING FANS

LINDEN OUTDOOR 52 LED

LED WET

BLADES

(5) Blades (Included)
12° Blade Pitch
52" Blade Sweep

BLADE MATERIAL

ABS

LAMPING

Downlight: (2) 9W LED Bulbs
Light Output: 1600 Lumens Net
CCT: 3000K
CRI: 90+

MOUNTING

Maximum Slope Angle with
Included Hardware: 30°

INCLUDED CONTROLS

Pull Chain Operation, 3-speed,
Manual Reverse Switch



COMPATIBLE ACCESSORIES

Slope Ceiling Canopy Kits MC95 & MC93 (pg. 400)
See Compatibility Chart (pg. 397 & 399)

FAN SPECIFICATIONS

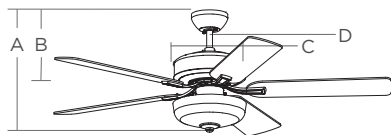

- A. Fixture Drop: 17.8"
- B. Blade Drop: 11.4"
- C. Housing Width: 10.3"
- D. Downrod: 4.5" (additional lengths pg. 401)

Motor Size: 153mm x 15mm

FTC ENERGY GUIDE

STANDARD	HIGH SPEED	WEIGHTED AVERAGE
ELECTRICITY	62 Watts	40 Watts
AIRFLOW	5051 CFM	3778 CFM
ENERGY COSTS	N/A	\$11 Per Year
EFFICIENCY	81 CFM/Watt	94 CFM/Watt

FTC ENERGY GUIDE

HUGGER	HIGH SPEED	WEIGHTED AVERAGE
ELECTRICITY	62 Watts	40 Watts
AIRFLOW	4251 CFM	3178 CFM
ENERGY COSTS	N/A	\$11 Per Year
EFFICIENCY	68 CFM/Watt	79 CFM/Watt



5LDO52BZD
Bronze Housing
Bronze ABS Blades
Matte White Glass



5LDO52MBKD
Midnight Black Housing
Midnight Black ABS Blades
Matte White Glass



5LDO52RZWD
Matte White Housing
Matte White ABS Blades
Matte White Glass

LINDEN OUTDOOR 44

WET

BLADES

(5) Blades (Included)
 12° Blade Pitch
 44" Blade Sweep

BLADE MATERIAL

ABS

MOUNTING

Maximum Slope Angle with
 Included Hardware: 30°

INCLUDED CONTROLS

Pull Chain Operation, 3-speed,
 Manual Reverse Switch



COMPATIBLE ACCESSORIES

Slope Ceiling Canopy Kits MC95 & MC93 (pg. 400)
 Light Kit Adaptable (pg. 403)

FAN SPECIFICATIONS

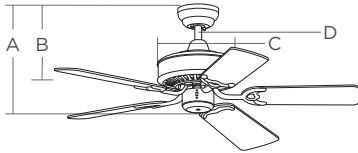

- A. Fixture Drop: 13.3"
- B. Blade Drop: 11.4"
- C. Housing Width: 10.3"
- D. Downrod: 4.5" (additional lengths pg. 401)

Motor Size: 153mm x 12mm

FTC ENERGY GUIDE

STANDARD	HIGH SPEED	WEIGHTED AVERAGE
ELECTRICITY	50 Watts	34 Watts
AIRFLOW	3835 CFM	3067 CFM
ENERGY COSTS	N/A	\$10 Per Year
EFFICIENCY	76 CFM/Watt	90 CFM/Watt

FTC ENERGY GUIDE

HUGGER	HIGH SPEED	WEIGHTED AVERAGE
ELECTRICITY	50 Watts	34 Watts
AIRFLOW	3062 CFM	2440 CFM
ENERGY COSTS	N/A	\$10 Per Year
EFFICIENCY	61 CFM/Watt	72 CFM/Watt



5LDO44BZ
 Bronze Housing
 Bronze ABS Blades



5LDO44MBK
 Midnight Black Housing
 Midnight Black ABS Blades



5LDO44RZW
 Matte White Housing
 Matte White ABS Blades

DISCUS OUTDOOR 52 LED CEILING FANS

DISCUS OUTDOOR 52 LED

LED WET

BLADES

(5) Blades (Included)
12° Blade Pitch
52" Blade Sweep

BLADE MATERIAL

ABS

LAMPING

Integrated LED: 20W
Light Output: 715 Lumens Net
CCT: 2700K
CRI: 90+
Optional MC360 Finishing Cap Available (pg. 402)

MOUNTING

Maximum Slope Angle with
Included Hardware: 30°

INCLUDED CONTROLS

Pull Chain Operation, 3-speed,
Manual Reverse Switch



COMPATIBLE ACCESSORIES

Slope Ceiling Canopy Kits MC95 & MC93 (pg. 400)
See Control Compatibility Charts (pg. 397 & 399)

FAN SPECIFICATIONS

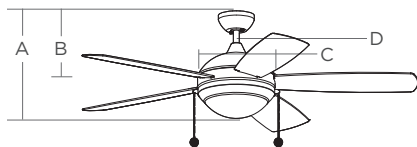

- A. Fixture Drop: 15.1"
- B. Blade Drop: 10.6"
- C. Housing Width: 11.1"
- D. Downrod: 4.5" (additional lengths pg. 401)

Motor Size: 153mm x 18mm

FTC ENERGY GUIDE

STANDARD	HIGH SPEED	WEIGHTED AVERAGE
ELECTRICITY	61 Watts	39 Watts
AIRFLOW	4470 CFM	3266 CFM
ENERGY COSTS	N/A	\$11 Per Year
EFFICIENCY	73 CFM/Watt	83 CFM/Watt



5DIW52RBD
Roman Bronze Housing
Roman Bronze ABS Blades
Matte Opal Glass



5DIW52PBSD
Painted Brushed Steel Housing
Painted Brushed Steel ABS Blades
Matte Opal Glass



5DIW52BKD
Matte Black Housing
Matte Black ABS Blades
Matte Opal Glass



5DIW52WHD
White Housing
White ABS Blades
Matte Opal Glass

CRUISE OUTDOOR 52

WET

BLADES

(5) Blades (Included)
 13° Blade Pitch
 52" Blade Sweep

BLADE MATERIAL

ABS

MOUNTING

Maximum Slope Angle with
 Included Hardware: 30°

INCLUDED CONTROLS

Pull Chain Operation, 3-speed,
 Manual Reverse Switch



COMPATIBLE ACCESSORIES

Slope Ceiling Canopy Kits MC95 & MC93 (pg. 400)
 Light Kit Adaptable (pg. 403)
 See Compatibility Chart (pg. 397 & 399)

FAN SPECIFICATIONS

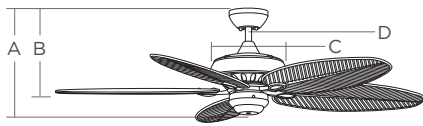

- A. Fixture Drop: 14"
- B. Blade Drop: 10.9"
- C. Housing Width: 10.4"
- D. Downrod: 4.5" (additional lengths pg. 401)

Motor Size: 172mm x 20mm

FTC ENERGY GUIDE

STANDARD	HIGH SPEED	WEIGHTED AVERAGE
ELECTRICITY	68 Watts	42 Watts
AIRFLOW	4324 CFM	3238 CFM
ENERGY COSTS	N/A	\$12 Per Year
EFFICIENCY	64 CFM/Watt	76 CFM/Watt



5CU52RB
 Roman Bronze Housing
 American Walnut ABS Blades



5CU52BK
 Midnight Black Housing
 Black ABS Blades

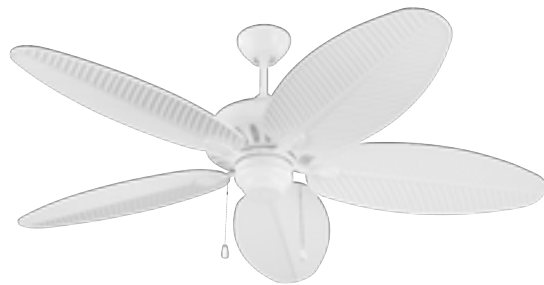

5CU52WH
 White Housing
 White ABS Blades

NEO MAGNETIC HAND-HELD & WALL MOUNT | Battery Operated | Hard Wired



MCR C1 (Universal)

- Hand-held or wall mount
- Works with virtually all pull-chain fans
- Non-reversing fan and light control
- Canopy installed receiver
- Can be used with MCR C3



(Transmitter)



(Receiver)

TRANSMITTER AND FAN RECEIVER
MCR C1

TRANSMITTER ONLY
MCR C1T



MCR C3 (Universal)

- 2-wire wall control
- Works with virtually all pull-chain fans
- Non-reversing fan and light control
- Canopy installed receiver
- Includes white and almond face plates
- Can be used with MCR C1



(Transmitter)



(Receiver)

TRANSMITTER AND FAN RECEIVER
MCR C3

TRANSMITTER ONLY
MCR C3W

COMBO WALL-MOUNT, HAND-HELD WALL CONTROL



CK250 (Combo Wall-Mount/Hand-Held Ki)

- Non-reversing fan and dimming downlight control
- Canopy installed receiver
- 3-speed
- Battery-operated hand-held transmitter or wall control (no hardwiring required)
- Dip switch control offering 16 different frequencies
- 1,000W surge protection
- White and almond face plates included



(Transmitter)



(Receiver)



(Includes Enclosure for Hand-Held Use)

TRANSMITTER ONLY
CT100 (does not reverse fan)



CK300 (Combo Wall-Mount/Hand-Held Ki)

- Reversing fan and dimming downlight control
- Switch housing installed receiver
- 3-speed
- Battery-operated hand-held transmitter or wall control (no hardwiring required)
- Dip switch control offering 16 different frequencies
- 1,000W surge protection
- White and almond face plates included



(Transmitter)



(Receiver)



(Includes Enclosure for Hand-Held Use)

TRANSMITTER ONLY
CT150

	NEO REMOTE CONTROL KIT	NEO TRANSMITTER ONLY	COMBO HAND-HELD/WALL REMOTE KIT	
	MCRC1 MCRC3	MCRC1T MCRC3W	CK250	CK300
Colony 60 LED	x	x	x	
Colony 60	x	x	x	
Colony 52 LED	x	x	x	
Colony 52	x	x	x	
Cruise Outdoor 52	x	x	x	x
Discus Classic 52 LED	x	x	x	
Discus Classic 44 LED	x	x	x	
Discus Ornate 52 LED	x	x	x	
Discus Outdoor 52 LED	x	x	x	
Era 52 LED	x	x	x	
Era 44 LED	x	x	x	
Jovie 44	x	x	x	
Jovie 44 LED	x	x	x	
Jovie 52	x	x	x	
Jovie 52 LED	x	x	x	
Linden 52 LED	x	x	x	
Linden 52	x	x	x	
Linden 48 LED	x	x	x	
Linden 48	x	x	x	
Linden Outdoor 52 LED	x	x	x	
Linden Outdoor 44	x	x	x	
Syrus 52 LED	x	x	x	

Cant find the fan you are looking for?

This means it is offered with its own remote control, included in the box. For remote control details, please check the fan's product page.

WALL MOUNT CONTROLS



ESWC-1 (Wall Control)

- Rotary-style fan wall control
- 3-speed
- Includes ivory and white knobs
- Face plate not included



ESSWC-3-WH (Wall Control)

- Converts standard two-wire wall switch to a four-speed (High, Medium/High, Medium, Low) fan control



ESSWC-4-WH (Wall Control)

- For use with extra heavy duty 212mm motors
- Converts standard two-wire wall switch to a heavy duty (212mm motor fans) four-speed (high, medium/high, medium, low) fan control



ESSWC-5-WH (Wall Control)

- Converts standard wall switch to fan and on/off light control
- Wall switch must have three wires, (with two hot leads) to operate both fan and light separately



ESSWC-6-WH (Wall Control)

- 4-speed wall control
- Converts standard wall switch to a multi-function fan and light control
- Wall switch must have three wires, (with two hot leads) to operate both fan and light separately



ESSWC-10 (Wall Control)

- 6-speed wall transmitter
- Reversing fan and light control
- LED light dimmer



ESSWC-11 (Wall Control)

- 3-speed wall transmitter
- Reversing fan and light control
- LED light dimmer
- Variable Breeze



MCSMRC (Smart AC Control)

- Hand-held or wall mount
- Converts non-Smart fans into Smart fans
- Works with virtually all AC motor fans
- Non-reversing fan and light control
- Canopy installed receiver
- 4 Speeds

DIRECT WIRED WALL CONTROLS

	ESWC-1	ESSWC-3-WH	ESSWC-4-WH	ESSWC-5-WH	ESSWC-6-WH
Colony 60 LED				x	x
Colony 60	x	x	x	x	x
Colony 52 LED				x	x
Colony 52	x	x	x	x	x
Cruise Outdoor 52	x	x	x	x	x
Discus Classic 52 LED				x	x
Discus Classic 44 LED				x	x
Discus Ornate 52 LED				x	x
Discus Outdoor 52 LED				x	x
Era 52 LED				x	x
Era 44 LED				x	x
Linden 52 LED				x	x
Linden 52				x	x
Linden 48 LED				x	x
Linden 48				x	x
Linden Outdoor 52 LED				x	x
Linden Outdoor 44				x	x
Syrus 52 LED	x	x		x	x

Cant find the fan you are looking for?

This means it is offered with its own remote control, included in the box. For remote control details, please check the fan's product page.

SLOPE CEILING CANOPY KITS CEILING FANS

MC93 (Slope Ceiling Canopy Kit)



MC93RB
Roman Bronze

For extreme sloped or vaulted ceilings (up to 46° pitch) this adapter can easily be mounted on most Visual Comfort & Co. models under 35 lbs.



MC93AGP
Aged Pewter



MC93BBS
Burnished Brass



MC93BK
Matte Black



MC93BS
Brushed Steel



MC93BZ
Bronze



MC93CH
Chrome



MC93KOA
Koa



MC93MBK
Midnight Black



MC93OZ
Oil Rubbed Bronze



MC93PN
Polished Nickel



MC93RB
Roman Bronze



MC93RZW
Matte White



MC93SN
Satin Nickel



MC93WH
White



MC93WGR
Washed Grey

MC95 (Slope Ceiling Canopy Kit)



MC95RB
Roman Bronze

For extreme sloped or vaulted ceilings (up to 46° pitch) this adapter can easily be mounted on most Visual Comfort & Co. models under 35 lbs.



MC95AGP
Aged Pewter



MC95BBS
Burnished Brass



MC95BK
Matte Black



MC95BS
Brushed Steel



MC95CH
Chrome



MC95BZ
Bronze



MC95GRY
Grey



MC95KOA
Koa



MC95BNZ
Deep Bronze



MC95OZ
Oil Rubbed Bronze



MC95PN
Polished Nickel



MC95RB
Roman Bronze

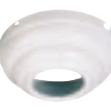

MC95RZW
Matte White



MC95SN
Satin Nickel

















MC95TI
Titanium



MC95WH
White

Our decorative downrods have pre-drilled holes on both ends. For optimum performance, we recommend that your ceiling fan be installed with the blades suspended 7' to 9' above the floor.

Standard 1/2" Diameter Downrods

Ceiling Height		9 FT	10 FT	11 FT	12 FT	13 FT	14 FT	15 FT
Suggested Downrod Length		12 IN	18 IN	24 IN	36 IN	48 IN	60 IN	72 IN
Aged Pewter 		DR12AGP	DR18AGP	DR24AGP	DR36AGP	DR48AGP	DR60AGP	DR72AGP
Bronze 		DR12BZ	DR18BZ	DR24BZ	DR36BZ	DR48BZ	DR60BZ	DR72BZ
Brushed Steel 		DR12BS	DR18BS	DR24BS	DR36BS	DR48BS	DR60BS	DR72BS
Burnished Brass 		DR12BBS	DR18BBS	DR24BBS	DR36BBS	DR48BBS	DR60BBS	DR72BBS
Deep Bronze 		DR12BNZ	DR18BNZ	DR24BNZ	DR36BNZ	DR48BNZ	DR60BNZ	DR72BNZ
Hand Rubbed Antique Brass 		DR12HAB	DR18HAB	DR24HAB	DR36HAB	DR48HAB	DR60HAB	DR72HAB
Matte Black 		DR12BK	DR18BK	DR24BK	DR36BK	DR48BK	DR60BK	DR72BK
Matte White 		DR12RZW	DR18RZW	DR24RZW	DR36RZW	DR48RZW	DR60RZW	DR72RZW
Midnight Black 		DR12MBK	DR18MBK	DR24MBK	DR36MBK	DR48MBK	DR60MBK	DR72MBK
Oil Rubbed Bronze 		DR12OZ	DR18OZ	DR24OZ	DR36OZ	DR48OZ	DR60OZ	DR72OZ
Polished Nickel 		DR12PN	DR18PN	DR24PN	DR36PN	DR48PN	DR60PN	DR72PN
Roman Bronze 		DR12RB	DR18RB	DR24RB	DR36RB	DR48RB	DR60RB	DR72RB
Satin Brass 		DR12SB	DR18SB	DR24SB	DR36SB	DR48SB	DR60SB	DR72SB
Satin Nickel 		DR12SN	DR18SN	DR24SN	DR36SN	DR48SN	DR60SN	DR72SN
White 		DR12WH	DR18WH	DR24WH	DR36WH	DR48WH	DR60WH	DR72WH

For use with Coastal fans.

Matte White 		DRC12RZW	DRC18RZW	DRC24RZW	DRC36RZW	DRC48RZW	DRC60RZW	DRC72RZW
Midnight Black 		DRC12MBK	DRC18MBK	DRC24MBK	DRC36MBK	DRC48MBK	DRC60MBK	DRC72MBK

MC360



MC360RB
Roman Bronze



Shown: 5DISM52AGPD with Finishing Cap MC362AGP

Finishing Cap (Blanking Plate)
Exclusive for Discus Classic, Discus Ornate,
Discus Outdoor, Discus Smart fans.



MC360AGP
Aged Pewter



MC360BS
Brushed Steel



MC360BK
Matte Black



MC360RB
Roman Bronze



MC360RZW
Matte White

MC362



MCM362MBK
Midnight Black



Shown: 3ERHR52BSD with Finishing Cap MC360BS

Finishing Cap (Blanking Plate)
Exclusive for Era fans.



MC362AGP
Aged Pewter



MC362BS
Brushed Steel



MC362MBK
Midnight Black



MC362RZW
Matte White

These light kits are compatible with all Generation Lighting Fans that accommodate Light Kits

 <p>MC260</p>	<p>MC260 LED LIGHT KIT - H: 1.2" W: 5.1" - 18W Integrated LED - 3000K 1600 Lumens Net CRI 90+ - Frosted White Shade</p>	<p>MC260MBK Midnight Black</p> <p>MC260PN Polished Nickel</p>	<p>MC260RZW Matte White</p> <p>MC260BS Brushed Steel (shown)</p>
 <p>MC261</p>	<p>MC261 LED LIGHT KIT - H: 2.6" W: 11.2" - 21W Integrated LED - 3000K 1800 Lumens Net CRI 90+ - Frosted White Shade</p>	<p>MC261BS Brushed Steel</p> <p>MC261OZ Oil Rubbed Bronze</p>	<p>MC261RZW Matte White</p> <p>MC261AGP Aged Pewter (shown)</p>
 <p>MC264</p>	<p>MC264 LED WET T24 LIGHT KIT - H: 2.75" D: 7" - 20W Integrated LED - 3000K 700 Lumens Net CRI 90+ - Frosted Acrylic Lens</p>	<p>MC264AGP Aged Pewter</p> <p>MC264BK Midnight Black</p>	<p>MC264RZW Matte White (Shown)</p>
 <p>MC266</p>	<p>MC266 WET T24 LIGHT KIT - H: 3.625" D: 11.625" - (2) 9W Medium A19 LED Bulbs (Included) - 3000K 800 Lumens Net CRI 90+ - Matte White Glass</p>	<p>MC266BK Matte Black</p> <p>MC266RB Roman Bronze</p>	<p>MC266RZW Matte White</p> <p>MC266OZ Oil Rubbed Bronze (Shown)</p>
 <p>MC265</p>	<p>MC265 LED DAMP T24 LIGHT KIT - H: 2.75" D: 9" - 20W Integrated LED - 3000K 700 Lumens Net CRI 90+ - Frosted Acrylic Lens</p>	<p>MC265AGP Aged Pewter</p> <p>MC265BK Matte Black</p>	<p>MC265BS Brushed Steel</p> <p>MC265RZW Matte White (Shown)</p>

These light kits are compatible with the following collections:

Colony 60 Colony 52 Cruise 52 Linden 52 Linden 48 Linden Outdoor 44

 <p>MC224</p>	<p>MC224 LED HUGGER LIGHT KIT - H: 4.5" W: 12.4" - (3) Candelabra 6W LED Bulb (Included) - 2700K 1500 Lumens Net CRI 90+ - Light Frosted Glass</p>	<p>MC224RB-V1 Roman Bronze</p> <p>MC224RZW-V1 Matte White</p>	<p>MC224BS-V1 Brushed Steel (shown)</p>
 <p>MC242</p>	<p>MC242 LED DAMP LIGHT KIT - H: 4.9" W: 11.75" - (2) 9W Medium A19 LED Bulbs (Included) - 3000K 1600 Lumens Net CRI 90+ - Matte Opal Glass</p>	<p>Aged Pewter Brushed Steel Matte White</p>	<p>Oil Rubbed Bronze Roman Bronze (shown)</p>
 <p>MC247</p>	<p>MC247 LED DAMP LIGHT KIT - H: 3.8" W: 15.7" - (3) 9W Medium A19 LED Bulbs (Included) - 3000K 2400 Lumens Net CRI 90+ - Matte Opal Glass</p>	<p>MC247RZW Matte White</p> <p>MC247RB Roman Bronze</p>	<p>MC247BS Brushed Steel (shown)</p>



PRODUCT SHOWN: JANE LED TAPE (OBSCURED)

LIGHTING SYSTEMS

LIGHTING SYSTEMS



PRODUCT SHOWN: JANE LED TAPE IN EXTRUDED CHANNEL (OBSCURED)



UNDERCABINET

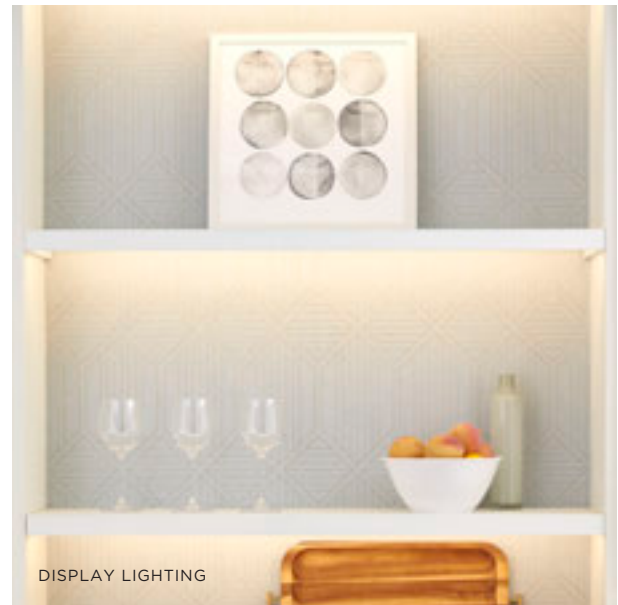

DISPLAY LIGHTING



COVE LIGHTING



CLOSET LIGHTING

A WEALTH OF APPLICATIONS

Generation Lighting is a trusted source for decorative and energy efficient accent lighting. We offer encased Undercabinet lighting, LED Disk Lights, Low-Voltage LED Linear Lighting, and our industry leading LX Cable System. We provide solutions for cove, undercabinet, display, and other accent lighting applications to create layers of lighting and visual interest. Our flexible, long-life LED linear lighting offers maximum flexibility - easy to install on most surfaces and field cuttable to ensure lighting that exactly meets your needs. Our product is certified for residential and commercial applications.



PRODUCT SHOWN: VIVID 120V LED 12"

Encased undercabinet lighting is a great supplement to the standard overhead lighting found in most kitchens, offices or retail spaces. At brighter levels it offers extra illumination for key tasks such as food preparation, reading or showcasing product. At lower levels it can be a wonderful accent when you are trying to set just the right mood for entertaining or unwinding at the end of the day.

We offer a variety of 120V LED systems to complement any application be it for a residential kitchen or for illuminating shelving in a retail setting. Each system comes in multiple lengths and features quick connects for powering via a wall outlet, knock-outs for hardwiring and the capability to easily link multiple units together.



VIVID 120V LED

The Vivid LED Undercabinet series takes the classic xenon or fluorescent undercabinet light to the next level. Using high quality LED technology, these fixtures achieve great light output and a high level of energy efficiency at an extremely affordable price point. With local on/off switches and the ability to be dimmed down to 10% these fixtures work well for different activities or times of day. In 2023, we will offer Vivid II as a transition from Vivid I with improved connector cords and updated LED components.



SELF-CONTAINED FLUORESCENT

Self-Contained Fluorescent Lighting is designed with quality and performance in mind. The low profile design is optimal for confined areas. High performance electronic ballasts and T5 lamps provide instant-on, flicker-free light. Contains multiple knockouts for ease of installation and linking units together.

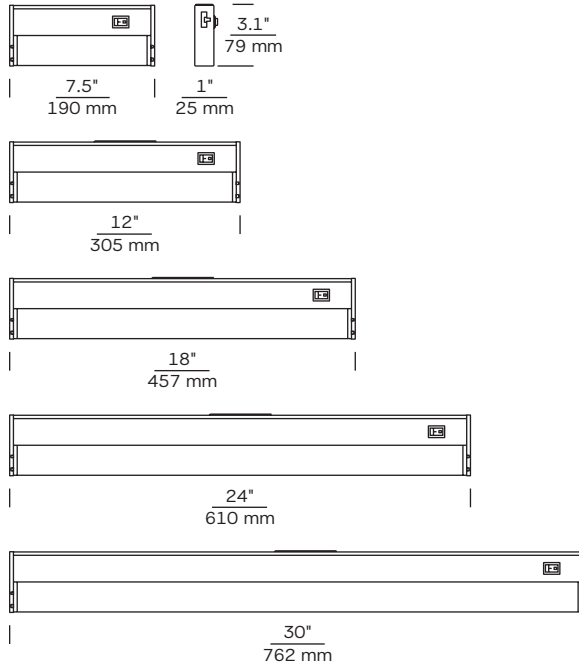

The Vivid LED Undercabinet series takes the classic xenon or fluorescent undercabinet light to the next level. Using high quality LED technology, these fixtures achieve great light output and a high level of energy efficiency at an extremely affordable price point.

2700K VIVID I	49274S-15	49275S-15	49276S-15	49277S-15	49278S-15
3000K VIVID I	49374S-15	49375S-15	49376S-15	49377S-15	49378S-15
3000K VIVID II	495193S-15	495293S-15	495393S-15	495493S-15	495593S-15
Length	7.5"	12"	18"	24"	30"
Voltage	120V DIRECT WIRE				
Lumens (@ 3000K)	VIVID I: 343	VIVID I: 575	VIVID I: 900	VIVID I: 1245	VIVID I: 1461
	VIVID II: 350, 575, 900, 1250, and 1450				
Power Consumption	VIVID I: 6.4W	VIVID I: 9.7W	VIVID I: 15.5W	VIVID I: 20.6W	VIVID I: 26W
	VIVID II: 5.1W, 8.1W, 12.2W, 16.7W, and 21W				
Efficacy	VIVID I: 54 LM/W	VIVID I: 59 LM/W	VIVID I: 58 LM/W	VIVID I: 60 LM/W	VIVID I: 55 LM/W
	VIVID II: 69, 71, 74, 75, AND 69 LM/W				
Color Rendering Index	90 CRI				
Rated Average Life	50,000 HOURS TO 70%				
Dimming range⁽¹⁾	DOWN TO 10%				
Installation	HARD WIRE OR PLUG IN WITH OPTIONAL POWER CORD ACCESSORY. LINK MULTIPLE UNITS WITH OPTIONAL CONNECTOR CORDS.				
Certification	EN* T24-I				
Features	LOCAL ON/OFF SWITCH				

⁽¹⁾ Vivid 120V LED is dimmable with a standard incandescent or electronic low voltage (ELV) dimmer. When sizing dimmer consult with the dimmer manufacturer for information on de-rating the dimmer for in-rush current.

BINNING CHART

Indicates how consistent color is from LED-to-LED along the black body curve of natural light. 1-step color binning helps ensure color variance is imperceptible to the human eye. Chart applies to all Vivid LED fixtures with a variance of 5%.

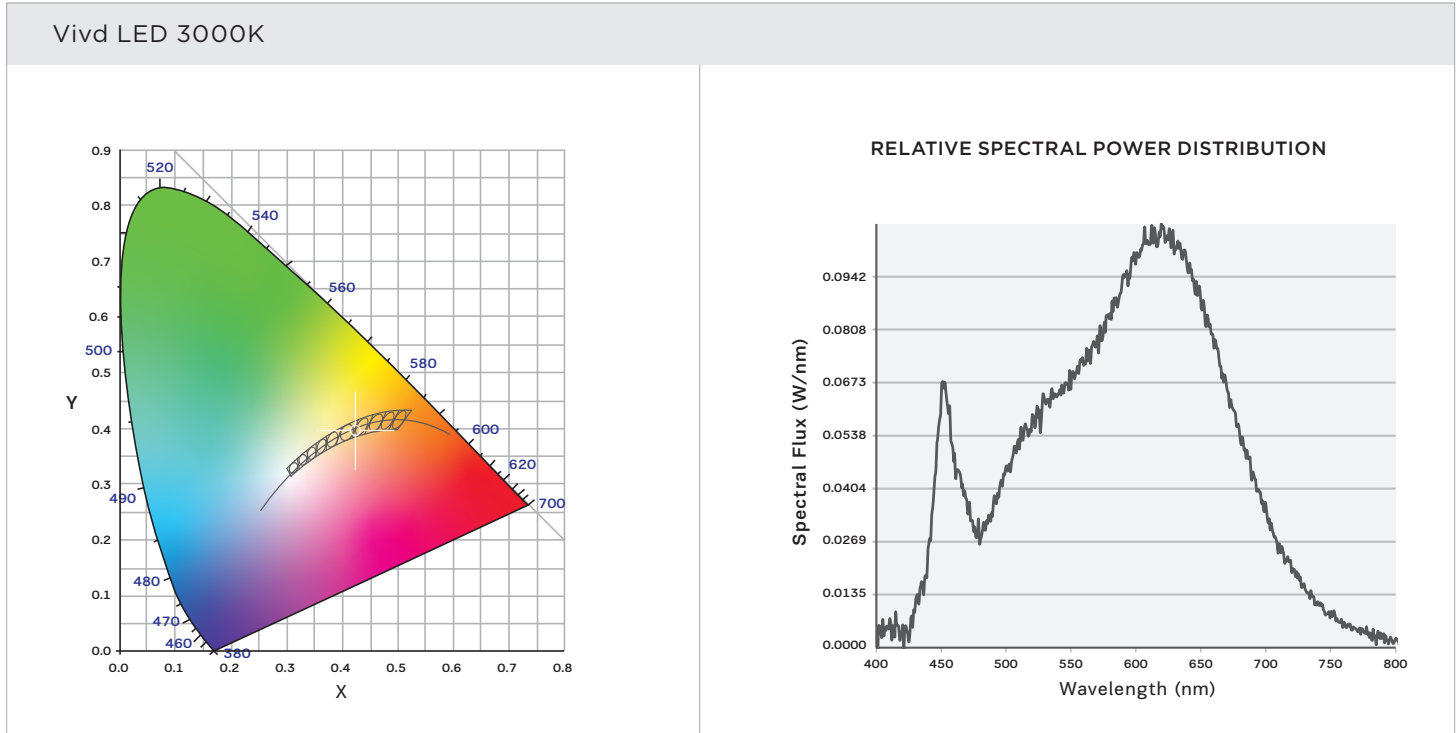

DIMMER COMPATIBILITY

Lutron	DIVA DVCL-153P, SKYLARK SCL-152P, LUMEA LECL-153P, SKYLARK CONTOUR CTCL-153P, MAESTRO MACL-153M, SUNNATA STCL-153, CASETA PD-6WCL, CASETA PD-5NE, MAESTRO MA-PRO, RADIORA 2 RRD-6NA, MAESTRO MRF2-6ELV, RADIORA 2 RRD-10ND, HOMEWORKS QS HQRD-10ND, RADIORA 2 RRD-H6BRL
RadioRa 2	HYBRID KEYPADS
Leviton	DECORA SMART DW1DK-1BZ, SURESLIDE 6672
Eaton	TOGGLE TAL06P2
Legrand	ADORNE ADTP600RMHW1, ADORNE ADTH700RMTUW1, RADIANT RHL743P
Forbes & Lomax	FLR603P-2ND GEN
Insteon	2477D
Control4	DECORA FORWARD PHASE C4-FPD120, ADAPTIVE PHASE C4-APD120

SELF-CONTAINED FLUORESCENT LIGHTING SYSTEMS

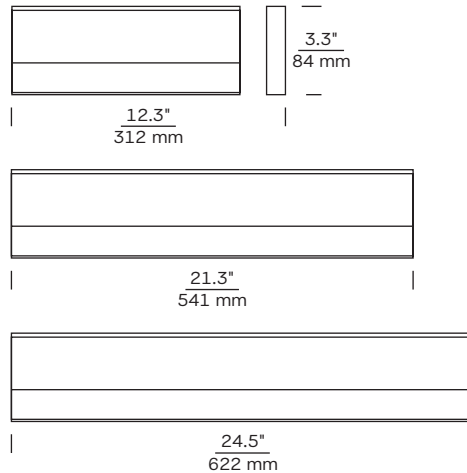

Self-Contained Fluorescent Lighting is designed with quality and performance in mind. The low profile design is optimal for confined areas. High performance electronic ballasts and T5 lamps provide instant-on, flicker-free light. Contains multiple knockouts for ease of installation and linking units together.



Item Number	4975BLE-15	4976BLE-15	4977BLE-15
Finish	WHITE (-15)		
Length	12.25"	21.25"	24.5"
Color Temperature	3000K		
Voltage	120V AC		
Gross Lumens ⁽¹⁾	390	855	780
Power Consumption	8W	13W	16W
Efficacy	49 LM/W	66 LM/W	49 LM/W
Color Rendering Index	>82 CRI		
Rated Average Lamp Life	10,000 HOURS		
Dimmable	NO		
Minimum Spacing	ADJACENT MOUNTING CAPABLE		
Includes	T5 LAMP		
Certification	DAMP I24-1		

⁽¹⁾ Gross Lumen level is derived from lamp source output. Some illumination is lost through diffuser. Actual light delivered to surface will be less.



PRODUCT SHOWN: SELF-CONTAINED FLUORESCENT (OBSCURED)

COMPONENT GUIDE

	CHOOSE FIXTURE				
VIVID I 120V LED 	2700K				
	49274S-15 Length: 7.5"	49275S-15 Length: 12"	49276S-15 Length: 18"	49277S-15 Length: 24"	49278S-15 Length: 30"
	3000K				
	49374S-15 Length: 7.5"	49375S-15 Length: 12"	49376S-15 Length: 18"	49377S-15 Length: 24"	49378S-15 Length: 30"
VIVID II 120V LED 	3000K				
	495193S-15 Length: 7.5"	495293S-15 Length: 12"	495393S-15 Length: 18"	495493S-15 Length: 24"	495593S-15 Length: 30"
SELF-CONTAINED FLUORESCENT 	3000K				
	4975BLE-15 Length: 12.25"	4976BLE-15 Length: 21.25"	4977BLE-15 Length: 24.5"		

Utilize this guide to draft a quick spec. Refer to page 439 for technical and dimming information.



A. CONNECTOR CORDS
Cords to join Vivid I Undercabinet fixtures together in a sequence.

95220S-15 Length: 3"	95221S-15 Length: 6"
95222S-15 Length: 12"	95223S-15 Length: 18"

B. MALE TO MALE CONNECTOR
Use to join Vivid I Undercabinet fixtures together in sequence with no gap in between units.

95236S-15
Length: 1"

C. FEMALE TO FEMALE CONNECTOR
Use to join a power and connector cord or two connector cords for longer runs.

95237S-15
Length: 1"



A. POWER CORDS
For plug-in installs where Vivid I Undercabinet fixtures will be powered via a wall outlet.

95230S-15 Length: 24"	95231S-15 Length: 72"
---------------------------------	---------------------------------



A. CONNECTOR CORDS
Cords to join Vivid II Undercabinet fixtures together in a sequence.

495603S-15 Length: 3"	495606S-15 Length: 6"
495612S-15 Length: 12"	
496624S-15 Length: 24"	

B. CONNECTOR
Use to join Vivid II Undercabinet fixtures together in sequence.

495688S-15

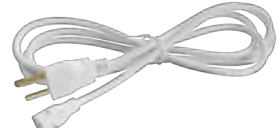

A. POWER CORDS
For plug-in installs where Vivid II Undercabinet fixtures will be powered via a wall outlet.

495624S-15 Length: 24"	495672S-15 Length: 72"
----------------------------------	----------------------------------



A. ON/OFF SWITCH (OPTIONAL)
Snaps into switch knock out on Self-Contained Fluorescent fixtures.

9027-15



PRODUCT SHOWN: LED DISK LIGHTS IN BRUSHED NICKEL FINISH

Disk Lights are convenient and small LED lights that feature a round, circular shape. They are becoming a popular addition to homes by creating a stunning lighting effect within glass-faced cabinets or above small, niche spaces. The compact, low-voltage light offers significant, yet gently diffused light output. Easily connect to multiple connectors to create a beautiful lighting system. Disk Lights' sturdy design enables install as either a recessed or surface mounted fixture based on the application.

Disk Lights are ideal for residential, commercial and retail applications with ample lumen output and versatility. Our Disk Lights are both linkable and dimmable, which allows homeowners to customize lighting as they see fit; available connector lengths include 3", 12", 36" and 72". Generation Lighting offers a combination of versatility, safety, energy efficiency and dimmability, making it a smart and practical choice for disk lighting.



DISK LIGHTS

Generation Lighting dimmable LED Disk Lights are the perfect solution for taking your accent lighting to the next level. A simple and sleek aluminum body allows these lights to blend in seamlessly with different styles of interior furnishing. The 3000K warm white light will create a comforting and inviting atmosphere in your home without irritating the eye. Our Disk Lights are designed to be extremely energy efficient, consuming only 3 watts per light and providing 90 CRI and 250 lumens output. Available in three finishes: White, Black or Brushed Nickel with an acrylic diffuser. Disk Lights are perfectly suitable for use in cabinets, closets, under counter, bookshelf, media center, etc. You can link up to 8 disk lights per run and with no bulbs to change and maintenance-free operation, expect reliable use for years to come.

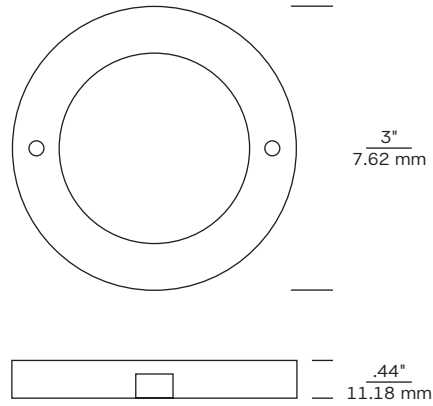

Disk Lights are ideal for residential, commercial and retail applications with ample lumen output and versatility.

3000K	984100S(-15 -962 -12)
Finish	WHITE (-15), BRUSHED NICKEL (-962), BLACK (-12)
Voltage	12V DC
Lumens Delivered at 3000K	250
Power Consumption	3W/DISK
Efficacy	90.9 LM/W
Color Rendering Index	90 CRI
Rated Average Life	35,000 HOURS TO 70%
Certification	IP20 RATED FOR INDOOR USE, ENERGY STAR® QUALIFIED
Dimmable⁽¹⁾	YES, TO 10%
Max. Run Length	8 DISKS / CONNECTION

BINNING CHART



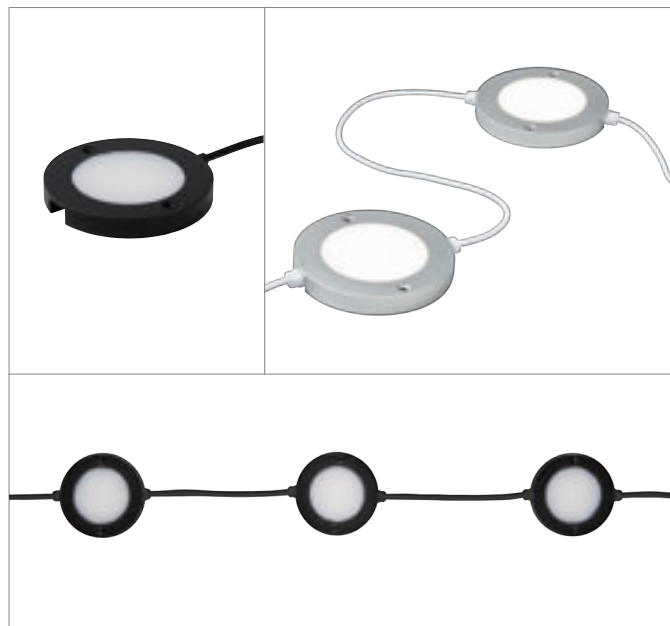
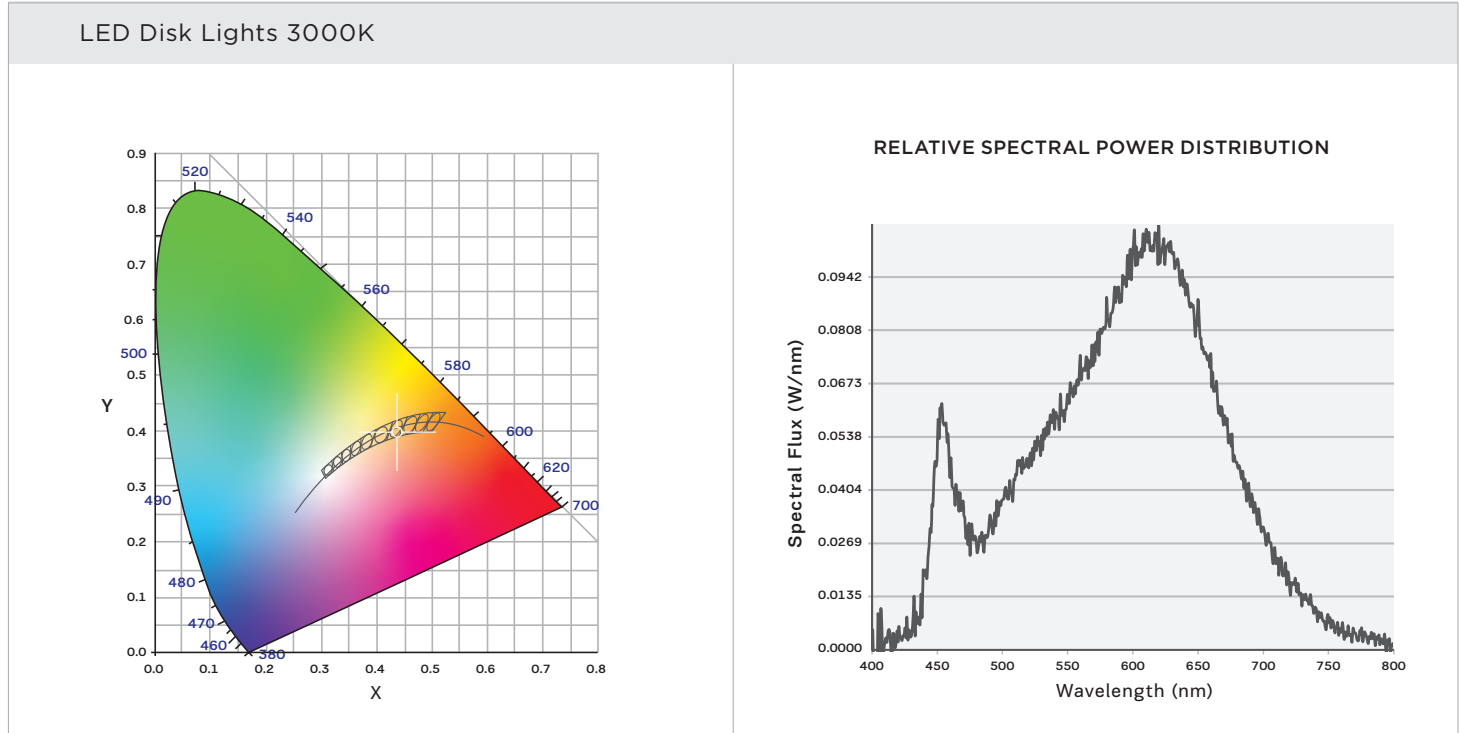



Indicates how consistent color is from LED-to-LED along the black body curve of natural light. 1-step color binning helps ensure color variance is imperceptible to the human eye. Chart applies to all LED Disk Light fixtures with a variance of 5%.

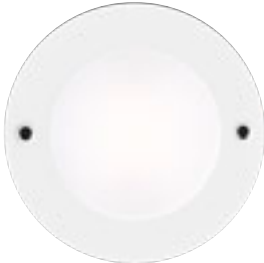

CONFIGURATION

Generation Lighting LED Disk lights can be configured in a daisy chain of up to 8 disks using our USB C to C cables.

COMPONENT GUIDE

CHOOSE FIXTURE	SELECT CONNECTORS	
<p>LED DISKS</p>  <p>White Finish (-15)</p>  <p>Brushed Nickel Finish (-962)</p>  <p>Black Finish (-12)</p> <p>984100S (-15 -962 -12) Diameter: 3" Height: 0.4375"</p>	 <p>A. TRANSFORMER POWER CORDS Cords have bare leads on one end for easy wiring to transformers and a USB C connector at other end for connecting to LED Disks.</p> <p>984124S(-12 -15) L: 24"</p> <p>984172S(-12 -15) L: 72"</p>  <p>B. PLUG IN POWER ADAPTOR CORDS Cords that have male USB input to male USB C output</p> <p>984024S(-12 -15) L: 24"</p> <p>984072S(-12 -15) L: 72"</p>	 <p>C. USB C TO USB C CABLE Connects LED Disk Lights together. Can also be used for wiring to remote transformers.</p> <p>984003S(-12 -15) L: 3"</p> <p>984006S(-12 -15) L: 6"</p> <p>984012S(-12 -15) L: 12"</p> <p>984018S(-12 -15) L: 18"</p>

Utilize this guide to draft a quick spec. Refer to page 438 for technical and dimming information.

SELECT ACCESSORIES	POWER SOURCE
<div data-bbox="239 724 524 898" data-label="Image"> </div> <div data-bbox="239 930 524 1037" data-label="Text"> <p>A. "Y" CONNECTOR CORD Use to split the low voltage LED Disk connector cords to create a parallel run. Female USB C input to 2 male USB C outputs.</p> </div> <div data-bbox="239 1056 406 1104" data-label="Text"> <p>984102S(-12 -15) L: 12"</p> </div> <div data-bbox="239 1163 541 1247" data-label="Text"> <p>B. MOUNTING CLIPS Space mounting clips according to run length to keep connector cords close to mounting surfaces.</p> </div> <div data-bbox="239 1266 413 1287" data-label="Text"> <p>984099S(-12 -15)</p> </div>	<div data-bbox="1034 718 1454 850" data-label="Image"> </div> <div data-bbox="1034 884 1527 1010" data-label="Text"> <p>A. TRANSFORMER Electronic Transformers, Indoor use only. 984218S-15 18W, 120V Primary, 12V DC Secondary. 984230S-15 30W, 120V Primary, 12V DC Secondary. 984240S-15 40W, 120V Primary, 12V DC Secondary. 984260S-15 60W, 120V Primary, 12V DC Secondary.</p> </div> <div data-bbox="1034 1029 1209 1077" data-label="Text"> <p>984218S-15 Maximum of 4 disks</p> </div> <div data-bbox="1034 1096 1209 1144" data-label="Text"> <p>984230S-15 Maximum of 8 disks</p> </div> <div data-bbox="1034 1188 1199 1312" data-label="Image"> </div> <div data-bbox="1034 1362 1546 1425" data-label="Text"> <p>B. PLUG IN POWER ADAPTOR 120V plug in transformer, 12V DC 1 Amp output for use with USB C connectors.</p> </div> <div data-bbox="1034 1444 1209 1493" data-label="Text"> <p>984201S(-12 -15) Maximum of 4 disks</p> </div>



PRODUCT SHOWN: JANE LED TAPE

Small form factor, linear task and accent lighting is critical in residential and commercial spaces to layer light and create visual interest while placing light exactly where it is needed. LED Tape and Channels are often placed near a surface – frequently a white or light-colored surface which tends to pick up LED color variances adjacent to each other. We are proud to offer high color quality and consistency across our LED Tape and Accent Lighting lineup.



JANE LED TAPE

Jane LED Tape is perfect for a wide range of indoor applications where space is limited. Its low-profile design and flexibility allow for discrete installation in spaces like under cabinets, cove ceilings, toe-kicks, in cabinets or even in drawers. Jane 200 features high quality LED diodes that meet a stringent three-step binning threshold for maintaining a consistent color of light across an entire run.



EXTRUDED CHANNEL

When space allows, create an Extruded Channel, by simply fitting Jane LED tape into 4' sections of polycarbonate track. For maximum flexibility, our track can be cut to size in the field. It mounts flat or at a 45-degree angle using screws or double-sided tape. The track is available with a flat, frosted lens to protect Jane LED tape and reduce pixelation while providing a wider beam of light.



EXTRUDED CHANNEL LENS

Flat, frosted lens for use with extruded channel to protect Jane LED tape and reduce pixelation while providing a wider beam of light. Sold separate from extruded channel.

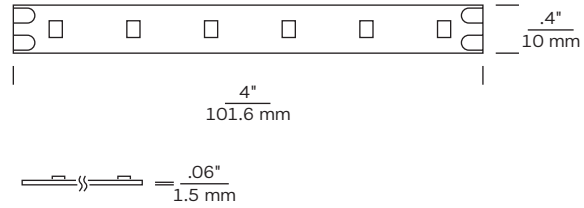
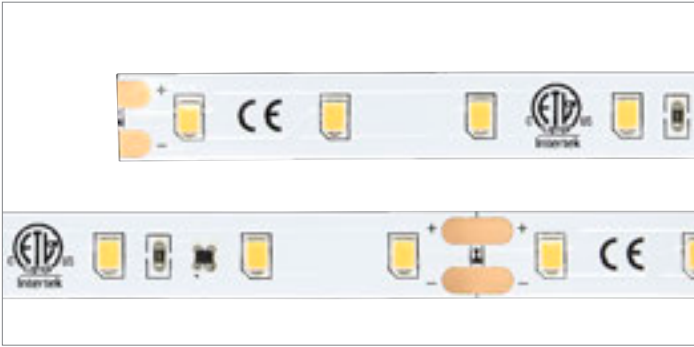

JANE 200 LED TAPE

Jane 200 features high quality LED diodes that meet a stringent three-step binning threshold for maintaining a consistent color of light across an entire run.

2700K	900004-15	900006-15
3000K	900005-15	900007-15
Length	40'	10'
Finish	WHITE (-15)	
Voltage	24V DC	
Lumens Delivered at 3000K	200/FT	
Power Consumption	2.2W/FT	
Efficacy	90.9 LM/W	90.9 LM/W
Color Rendering Index	90 CRI	
Rated Average Life	50,000 HOURS TO 70%	
Certification	IP20 RATED FOR INDOOR USE, ENERGY STAR® QUALIFIED	
Dimmable⁽¹⁾	YES, TO 10%	
Max. Run Length	40'	
Installation	CUT EVERY 4" TO FIT YOUR SPACE. EVERY CUT PIECE CAN BE POWERED. CONNECT TO TRANSFORMER USING CONNECTOR CORD. YOU MAY ALSO CONNECT STRIPS TOGETHER USING AVAILABLE CONNECTOR CORDS.	



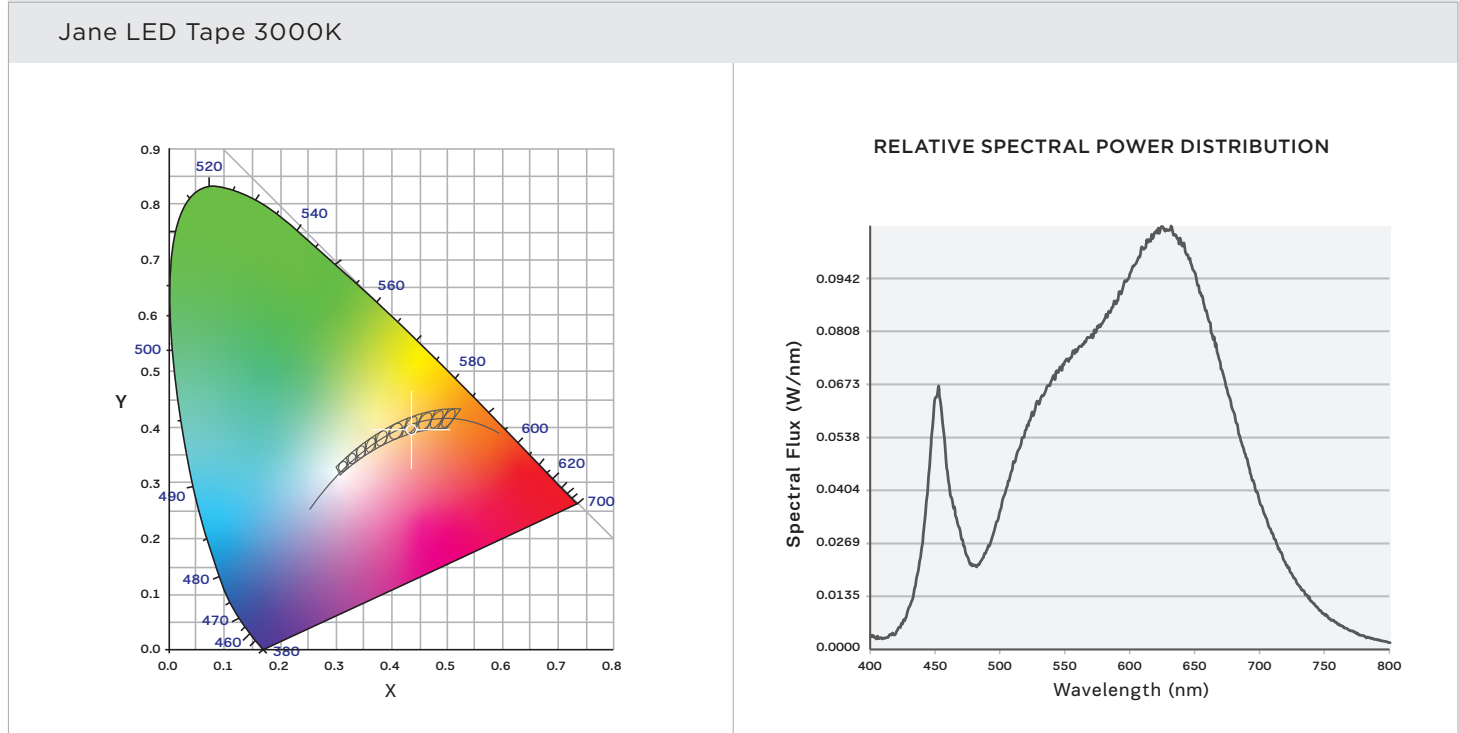

⁽¹⁾ Jane LED Tape is dimmable on magnetic and electronic low voltage systems. For magnetic systems, a standard incandescent or magnetic low voltage (MLV) can be used. For electronic, an electronic low voltage (ELV) dimmer is recommended.

BINNING CHART

Indicates how consistent color is from LED-to-LED along the black body curve of natural light. 1-step color binning helps ensure color variance is imperceptible to the human eye. Chart applies to all LED Disk Light fixtures with a variance of 5%.

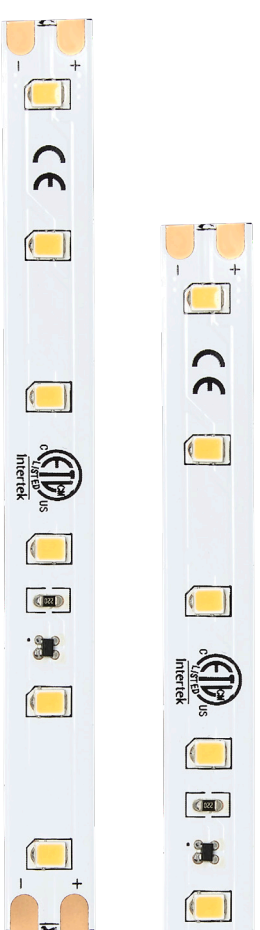

COMPONENT GUIDE

	CHOOSE FIXTURE		SELECT CONNECTORS									
<p>JANE 200 LED TAPE</p> 	2700K		 <p>A. CONNECTOR CORDS Cords with fold-over clasps on either end for quick and secure connections between two pieces of Jane 200 LED Tape.</p> <table border="0"> <tr> <td>905002-15 Length: 3"</td> <td>905003-15 Length: 6"</td> <td>905004-15 Length: 12"</td> </tr> <tr> <td>905005-15 Length: 18"</td> <td>905006-15 Length: 24"</td> <td>905007-15 Length: 36"</td> </tr> <tr> <td colspan="3">905040-15 Length: 72"</td> </tr> </table>  <p>B. POWER CORD For connecting Jane LED Tape to 24V DC Transformer. Cord has bare leads on one end for easy wiring to transformer and a fold-over clasp on the other for a quick, secure connection to LED tape.</p> <p>905000-15 Length: 96"</p>  <p>C. JOINER CONNECTOR Adapter with fold-over clasps on each end for linking two pieces of Jane 200 tape together with minimal gap.</p> <p>905001-15 Length: .812" Width: 5" Height: .187"</p>	905002-15 Length: 3"	905003-15 Length: 6"	905004-15 Length: 12"	905005-15 Length: 18"	905006-15 Length: 24"	905007-15 Length: 36"	905040-15 Length: 72"		
	905002-15 Length: 3"	905003-15 Length: 6"		905004-15 Length: 12"								
	905005-15 Length: 18"	905006-15 Length: 24"		905007-15 Length: 36"								
	905040-15 Length: 72"											
900006-15 Length: 10"	900004-15 Length: 40"											
3000K												
900007-15 Length: 10"	900005-15 Length: 40"											

Utilize this guide to draft a quick spec. Refer to page 437 for technical information and compatible dimmers on transformers.

SELECT ACCESSORIES	SELECT POWER SOURCE
<div data-bbox="222 661 564 835" data-label="Image"> </div> <p>A. EXTRUDED CHANNEL 4' sections of polycarbonate track, able to be cut to size in the field. Channel mounts flat or at a 45-degree angle using screws or double-sided tape.</p> <p>98670-15 Length: 48" Width: .75" Height: .0.5"</p> <div data-bbox="222 1039 564 1171" data-label="Image"> </div> <p>B. EXTRUDED CHANNEL FLAT LENS Flat, frosted lens for use with extruded channel to protect Jane 200 LED tape and reduce pixelation while providing a wider beam of light. Sold separate from extruded channel.</p> <p>98672-97 Length: 48" Width: .625" Height: .0.6"</p> <div data-bbox="222 1386 494 1648" data-label="Text"> <p>C. DOUBLE FACED TAPE L: 25' W: .375" H: .031" Specially designed "High Adhesion" 3M™ double-faced tape for use with LED extruded channel. Allow minimum 24 hours curing of adhesive prior to applying power to the circuit.</p> <p>9450 3M™</p> </div> <div data-bbox="512 1386 720 1564" data-label="Text"> <p>D. CHANNEL SCREWS (50PCS) 5/8" long #4 Phillips flat head screws for securely mounting LED extruded channel.</p> <p>9862</p> </div> <div data-bbox="755 1386 963 1543" data-label="Text"> <p>E. LED TAPE CLIPS (10PCS) Metal clips for securing LED tape. Brushed Steel finish.</p> <p>905045-32</p> </div>	<div data-bbox="1102 724 1397 871" data-label="Image"> </div> <p>A. ELECTRONIC TRANSFORMERS Electronic Transformers, Indoor use only. 98745S-12 60W, 120V Primary, 24V DC Secondary. 98746S-12 105W, 120V Primary, 24V DC Secondary. 98747S-12 150W, 120V Primary, 24V DC Secondary.</p> <p>98745S-12 L: 9.375" W: 2.5" H: 1.375"</p> <p>98746S-12 L: 11" W: 4" H: 2.25"</p> <p>98747S-12 L: 11" W: 4" H: 2.25"</p> <div data-bbox="1102 1249 1345 1407" data-label="Image"> </div> <p>B. MAGNETIC TRANSFORMER Magnetic Transformer, Wet or Indoor use. 98743S-12 200W, 120V Primary, 24V DC Secondary.</p> <p>98743S-12 L: 8.78" W: 3.75" H: 4.25"</p>



PRODUCT SHOWN: LED FESTOON (OBSCURED)

The Generation Lighting LX Cable System is our premier lighting solution giving users the utmost flexibility to easily design and install customized lighting to meet the specific needs of their space. Simply identify the length of run for which you will need cable, choose the lamping modules best suited for your application, and select a transformer.

Our LX Cable System is uniquely engineered so that you can mix and match any of our lamping modules on the same system. The snap-on design enables quick installation and the ability to adjust over time as lighting needs or preferences change.



HIGH OUTPUT LED MODULES

The miniature, High Output LED Modules can be used with 12V Generation Lighting LX Cable Systems powered by magnetic low-voltage or electronic low-voltage transformers.



LED FESTOON

Upgrade to our LX LED Festoons from our 5W Xenon Festoons and realize an energy savings of over 80% without compromising light output. LX LED Festoons snap into LX Festoon Lampholders (sold separately), making retrofitting of existing systems easy.



XENON FESTOON

Generation Lighting LX Xenon Festoons revolutionized the under cabinet lighting industry and continue to be an industry standard.

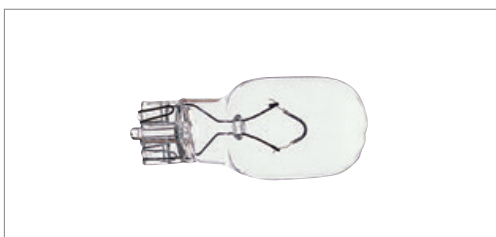

WEDGE BASE

LX Wedge Base Lamps provide illumination for a varied list of applications. LX Wedge Base Lamps add another level of versatility to Generation Lighting LX Cable systems.

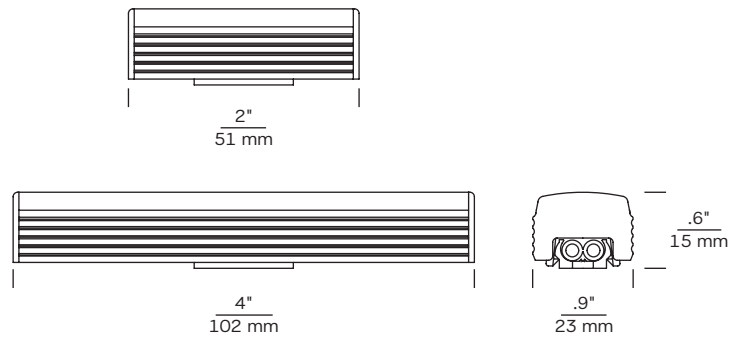

Simply snap the LED modules onto LX track and cable to provide a generous amount of illumination without the need for a lampholder. These high intensity LED modules utilize wider recommended spacing than our festoons while still providing even surface illumination.

Item Number	98700S-986	98701S-986	98702S-986	98703S-986
Length	2"		4"	
Color Temperature	2700K	3000K	2700K	3000K
Voltage	12V AC			
Finish	TINTED ALUMINUM (-986)			
Diffuser	FROSTED			
Delivered Lumens	85	90	220	230
Power Consumption	1.7W		4W	
Efficacy	50 LM/W	53 LM/W	55 LM/W	58 LM/W
Color Rendering Index	90 CRI			
Rated Average Life	50,000 HOURS TO 70%			
Dimmable ⁽¹⁾	DOWN TO 10%			
Installation	HIGH OUTPUT LED MODULES SNAP ONTO THE LX TRACK			
Recommended Spacing	6" ON CENTER (1" MINIMUM SEPARATION)		12" ON CENTER (1" MINIMUM SEPARATION)	
Certification	ETL			

⁽¹⁾ Generation Lighting High Output LED Modules are dimmable on magnetic and electronic low voltage systems. For magnetic systems, a standard incandescent or magnetic low voltage (MLV) dimmer can be used. For electronic, an electronic low voltage (ELV) dimmer is recommended.

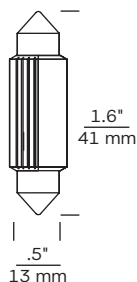

For new systems, pick a matching LX Festoon Lampholder and clip them onto your LX Cable and Track. LX LED Festoons are available in 2700 and 3000K in 12V (lampholder sold separately).

Item Number	96116S(-32 -33)	96118S(-32 -33)
Finish	CLEAR (-32), FROSTED (-33)	
Color Temperature	2700K	3000K
Voltage	12V AC	
Delivered Lumens	59	60
Power Consumption	.708W	
Efficacy	83 LM/W	85 LM/W
Color Rendering Index	>90 CRI	
Rated Average Life	50,000 HOURS TO 70%	
Dimmable ⁽¹⁾	DOWN TO 10%	
Lamp Base	FESTOON	
Recommended Spacing	4" ON CENTER (1" MINIMUM SEPARATION)	
Certification	CETL <small>DAMP</small>	

⁽¹⁾ LX LED Festoons are dimmable on magnetic and electronic low voltage systems. For magnetic systems, a standard incandescent or magnetic low voltage (MLV) dimmer can be used. For electronic, an electronic low voltage (ELV) dimmer is recommended. Lamps in chart above only compatible with Festoon Lampholder 9830.

FESTOON LAMPHOLDER

For use with our highly specified LED and Xenon festoons, Generation Lighting LX Festoon Lampholders feature a high quality reflector and base for directing light where you need it. Our Accent Task Socket for general applications provides crisp linear lighting. Each lampholder snaps onto LX Track and Cable with ease and can be spaced based on your criteria.

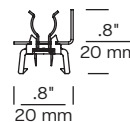
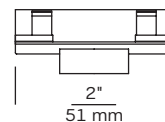

Item Numbers	9830(-15 -12)
Reflector	"L" ACCENT TASK SOCKET
Voltage	12V AC
Lamp Base	FESTOON
Certification	CETL <small>DAMP</small>
Maximum Wattage	(1) 10W XENON FESTOON (1) LED FESTOON
Recommended Minimum Spacing	2" ON CENTER (5W XENON) 4" ON CENTER (LED FESTOON)
Material	HEAT RESISTANT POLYCARBONATE BASE AND ANODIZED ALUMINUM REFLECTOR

Application	Recommended Spacing on Center	Suggested Lamp Source(s)
Above Cabinet	6" - 12"	LED FESTOON
Under Cabinet	2" - 6"	LED FESTOON
Inside Cabinet	1 - 2 PER SHELF	LED FESTOON
Toe Space	4"	LED FESTOON
Showcase	4" - 6"	LED FESTOON
Cove	2" - 6"	LED FESTOON

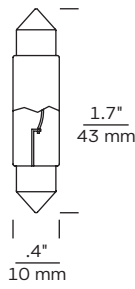

Xenon Festoon are available in 5W and 10W. Our directional lampholder easily positions light where you need it (lampholder sold separately).

Item Number	97118(-32 -33)	97119(-32 -33)
Color Temperature	2550K	2650K
Voltage	12V AC	12V AC
Rated Watts	5 WATTS	10 WATTS
Finish	CLEAR (-32), FROSTED (-33)	
Gross Lumens	33	83
Power Consumption	4.2W	8.4W
Efficacy	8 LM/W	10 LM/W
Color Rendering Index	>90 CRI	
Rated Average Life	16,000 HOURS	12,000 HOURS
Dimmable	YES	
Lamp Base	FESTOON	
Recommended Spacing	4" ON CENTER (1" MINIMUM SEPARATION)	

FESTOON LAMPHOLDER

For use with our highly specified LED and Xenon festoons, Generation Lighting LX Festoon Lampholders feature a high quality reflector and base for directing light where you need it. Our Accent Task Socket for general applications provides crisp linear lighting. Each lampholder snaps onto LX Track and Cable with ease and can be spaced based on your criteria.

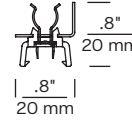
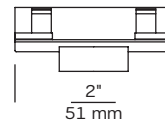

Item Numbers	9830(-15 -12)
Reflector	"L" ACCENT TASK SOCKET
Voltage	12V AC
Lamp Base	FESTOON
Certification	CETL <small>DAMP</small>
Maximum Wattage	(1) 10W XENON FESTOON (1) LED FESTOON
Recommended Minimum Spacing	2" ON CENTER (5W XENON) 4" ON CENTER (LED FESTOON)
Material	HEAT RESISTANT POLYCARBONATE BASE AND ANODIZED ALUMINUM REFLECTOR

APPLICATION GUIDE

Lamp Item #	Lampholder Spacing	Distance to Illuminated Surface				
		6"	12"	18"	24"	30"
97118(-32 -33)	2"	114	52	24	14	10
	4"	71	32	15	8.9	6.4
	6"	64	29	13	8	5.7
	8"	57	26	12	7.1	5.1
	10"	51	23	11	6.3	4.5
	12"	45	20	9.5	5.6	4.0
97119(-32 -33)	4"	179	81	38	22	16
	6"	160	72	34	20	14
	8"	142	64	30	18	13
	10"	128	58	27	16	11
	12"	114	52	24	14	10

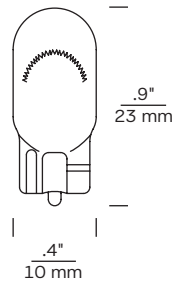

LX Wedge Base Lamps provide illumination for a varied list of applications. LX Wedge Base Lamps add another level of versatility to Generation Lighting LX Cable systems (lampholder sold separately).

Item Number	9728	9731	9732
Lamp Type	T3¼ INCANDESCENT	T3¼ XENON	T3¼ XENON
Color Temperature	2300K	2400K	2550K
Voltage	12V AC	12V AC	12V AC
Rated Watts	5W	3W	5W
Gross Lumens	23	15	33
Power Consumption	4W	2.7W	4.2W
Efficacy	6 LM/W	6 LM/W	8 LM/W
Color Rendering Index	>90 CRI	>90 CRI	>90 CRI
Rated Average Life	9,000 HOURS	19,000 HOURS	8,000 HOURS
Dimmable	YES	YES	YES
Lamp Base	WEDGE	WEDGE	WEDGE
Minimum Spacing	4" ON CENTER	4" ON CENTER	4" ON CENTER

WEDGE BASE LAMPHOLDER

For use with our xenon and incandescent wedge base lamps, Generation Lighting LX Wedge Base Lampholders feature a high quality reflector for minimizing light loss from your selected lamps. Each lampholder snaps onto LX Track and Cable with ease and can be spaced based on your criteria and lamp source (sold separately).

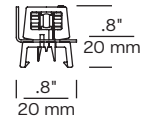
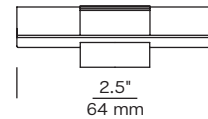









Item Number	9428(-15 -12)
Reflector	TWO LAMP SOCKET, IDEAL FOR COVE LIGHTING
Voltage	12V AC
Lamp Type	T3¼ WEDGE
Certification	CETL <small>DAMP</small>
Maximum Wattage	(2) 5W INCANDESCENT OR XENON
Recommended Minimum Spacing	4" ON CENTER
Material	HEAT RESISTANT POLYCARBONATE BASE AND ANODIZED ALUMINUM REFLECTOR











FOOTCANDLE & SPACING CHART

Application	Recommended Spacing on Center	Suggested Lamp Source(s)
Above Cabinet	2" - 4"	3W-5W INCANDESCENT OR XENON
Inside Cabinet	1 - 2 PER SHELF	3W-5W INCANDESCENT OR XENON
Toe Space	2" - 4"	3W-5W INCANDESCENT OR XENON
Cove	4"	3W-5W INCANDESCENT OR XENON

COMPONENT GUIDE

	CHOOSE FIXTURE		
HIGH OUTPUT LED MODULES 	2700K		3000K
	98700S-986 Length: 2"		98701S-986 Length: 2"
	98702S-986 Length: 4"		98703S-986 Length: 4"
LED FESTOON AND LAMPHOLDER   9830(-15 -12) 9830-12 shown	2700K		3000K
	96116S(-32 -33)		96118S-32
XENON FESTOON AND LAMPHOLDER   9830(-15 -12) 9830-15 shown	2550K		2650K
	97118(-32 -33)		97119(-32 -33)
WEDGE BASE AND LAMPHOLDER   9428(-15 -12) 9428-15 shown	2300K	2400K	2550K
	9728	9731	9732

Utilize this guide to draft a quick spec. Refer to page 437 for technical information and compatible dimmers on transformers.

SELECT ACCESSORIES		SELECT POWER SOURCE
 <p>A. TRACK Noryl® track to support cable and lampholders. Use double faced tape (9450), track clip (9438) or screws (9862) through pre-drilled holes to attach track to surface. Track may be flexed, notched, curved and easily cut for various applications.</p> <p>9435(-15 -12) L: 48" W: .5" H: .25"</p>	 <p>E. MINIATURE WIRING COMPARTMENT / SPLICER Polycarbonate splicer with cover for connection between transformer extension Wire (i.e. Romex) and low voltage cable, or LED Tape Connector. Maximum 25 amps.</p> <p>9459(-15 -12) L: 2" W: .968" H: .625"</p>	<p>A. MAGNETIC TRANSFORMERS Include boost tap for use when transformer is located 20' or more from first light.</p>  <p>94458-12 L: 8.75" W: 4.25" H: 3.75"</p>
 <p>B. TRACK WITH FASCIA PANEL One piece Noryl® fascia panel with integral track to support cable and lampholders. Use under shelves or where system cannot be hidden behind a lip on cabinets. Track/fascia may be easily cut to various lengths. Use double faced tape (9450) track clip (9438) or screws (9862) through pre-drilled holes to attach track/fascia to surface. Use double-faced tape on glass and other smooth surfaces.</p> <p>9443-12 L: 48" W: .5" H: .25"</p>	 <p>F. TAP OFF CONNECTOR Polycarbonate tap off connector. Use to tap off of low voltage Generation Lighting® Cable and create a parallel run for shelving, etc. Corrosion resistant contacts pierce the specially designed Generation Lighting® cable for electrical connection. Listed 12V and 24V. Wet location 12v only. Maximum wattage after connection on 105°C Generation Lighting® tap cable: 200W at 12V; 375W at 24V.</p> <p>9380(-15 -12) L: 1.5" W: 1.5" H: .437"</p>	<p>94460-12 L: 10.5" W: 4.312" H: 4.312"</p> <p>94462-12 L: 10.5" W: 4.375" H: 3.875"</p>
 <p>C. TRACK CLIP Polycarbonate track mounting clip. Easily snaps on at any point along 9435 track or 9443 track/fascia panel to secure to surface. Space clips according to weight of fixtures, to prevent track from sagging. Includes .375" long #4 screw.</p> <p>9438(-15 -12) L: 1" W: .75" H: .343"</p>	 <p>G. FUSED PLUG For powering multiple Generation Lighting low voltage luminaires from an LX Cable System. See page "Technical Information" for detailed wiring information.</p> <p>9488-12 L: .875" W: .75" H: .812"</p>	<p>B. ELECTRONIC TRANSFORMERS Include boost tap for use when transformer is located 20' or more from first light.</p>  <p>75W 12V ZERO-LOAD TRANSFORMER</p> <p>96622S-12 L: 7.805" W: 1.36" H: 0.949"</p>
 <p>D. INDOOR CABLE SPOOL Spools of cable especially designed with easy piercing, self-sealing insulation over stranded copper wire for use with Generation Lighting LX Cable Lighting system. Markings for lampholder placement every 2". Designed to be mounted in Generation Lighting LX Track. LX 10/2 AWG 105° C cable is rated for indoor use only. Maximum wattage per length 300W at 12V; 600w at 24V cable is not rated to run behind walls. Check with local codes.</p> <p>9471(-15 -12) 9470(-15 -12) L: 100' W: .375" H: .187" L: 50' W: .375" H: .187"</p> <p>9469(-15 -12) L: 25' W: .375" H: .187"</p>	 <p>H. WIRING COMPARTMENT Steel wiring compartment with hole for .5" conduit connector, snap on cover and opening for track and cable. Includes terminal block for connection between transformer extension Wire (i.e. Romex type) and low voltage cable. Maximum 25 amps.</p> <p>9481-15 L: 2" W: 1.312" H: 1.25"</p> <p>I. CHANNEL SCREWS 3/8" long #4 Phillips flat head screws for securely mounting LED extruded channel.</p> <p>9862</p> <p>J. DOUBLE FACED TAPE Specially designed "High Adhesion" 3M™ double-faced tape for use with LED extruded channel. Allow minimum 24 hours curing of adhesive prior to applying power to the circuit.</p> <p>9450 L: 25' W: .375" H: .031"</p>	 <p>150W 12V ZERO-LOAD TRANSFORMER</p> <p>96624S-12 L: 8.385" W: 2.53" H: 1.219"</p>

TRANSFORMERS

Generation Lighting power supplies deliver consistent, reliable energy, extending the life and quality of our lighting fixtures. Technical information, dimmer compatibility, as well as maximum run lengths are listed in the following section.



MAGNETIC TRANSFORMERS

Magnetic transformers are encased in a powder coated metal enclosure that is potted to minimize noise and vibration. All are UL/cUL listed, NEC 411 approved, thermally protected, dimmable, and have resettable magnetic circuit breakers for short circuit protection. Housings feature easy-hang bracket, wiring access door, and knockouts for line voltage entry.



ELECTRONIC TRANSFORMERS

The zero-load electronic transformers from Generation Lighting provide industry leading technology in a small form factor. All transformers now include radio frequency interference modules to eliminate interference that can occur when dimming low-voltage fixtures. These units also have the added benefits of local on/off switches and a user replaceable secondary side of the transformer that can be swapped without an electrician or even needing to touch the primary wiring.

JANE LED TAPE TRANSFORMERS



Magnetic Transformer	Compatible Dimmers
<p>200W, 24V DC SINGLE OUTPUT TRANSFORMER L: 8.78" W: 3.75" H: 4.25" 200W, 120V Primary, 24V DC Secondary, Magnetic Transformer, Black Powder Coated Enclosure, Wet or Dry Location</p> <p>98743S-12</p>	<p>Lutron Diva DVCL-153P, Lutron Skylark SCL-152P, Lutron Lumea LECL-153P, Lutron Skylark Contour CTCL-153P, Lutron Maestro MACL-153M, Lutron Sunnata STCL-153, Lutron Diva DVRP-253P, Lutron Caseta PD-6WCL, Lutron Caseta PD-5NE, Lutron Maestro MA-PRO, Lutron RadioRa 2 RRD-6NA, Lutron Maestro MRF2-6ELV, Lutron RadioRa 2 RRD-10ND, Lutron HomeWorks QS HQRD-10ND, Lutron Maestro MRF2S-6CL, Lutron RadioRa2 RRD-6CL, Lutron HomeWorks QS HQRD-6CL, Lutron HomeWorks QS HQRA-6CL, Lutron RadioRa 2 RRD-H6BRL, RadioRa 2 Hybrid Keypads, Leviton Toggle TSLO6, Leviton Decora Smart DWIDK-1BZ, Leviton Decora DSLO6 SSL7A, Eaton Toggle TAL06P2, Legrand Adorne ADTP600RMHW1, Legrand Adorne ADTH700RMTUW1, Insteon 2477D, Control4 Decora Forward Phase C4-FPD120, Control4 Adaptive Phase C4-APD120</p>



Electronic Transformers	Compatible Dimmers
<p>60W, 24V DC SINGLE OUTPUT TRANSFORMER L: 9.375" W: 2.5" H: 1.375" 60W, 120V Primary, 24V DC Secondary, Electronic Transformer, Black Powder Coated Enclosure, Indoor Use Only.</p> <p>98745S-12</p>	<p>Lutron Diva DVCL-153P, Lutron Skylark SCL-152P, Lutron Lumea LECL-153P, Lutron Skylark Contour CTCL-153P, Lutron Maestro MACL-153M, Lutron Sunnata STCL-153, Lutron Diva DVRP-253P, Lutron Caseta PD-6WCL, Lutron Caseta PD-5NE, Lutron Maestro MA-PRO, Lutron RadioRa 2 RRD-6NA, Lutron Maestro MRF2-6ELV, Lutron RadioRa 2 RRD-10ND, Lutron HomeWorks QS HQRD-10ND, Lutron Maestro MRF2S-6CL, Lutron RadioRa2 RRD-6CL, Lutron HomeWorks QS HQRD-6CL, Lutron HomeWorks QS HQRA-6CL, Lutron RadioRa 2 RRD-H6BRL, RadioRa 2 Hybrid Keypads, Leviton Toggle TSL06, Leviton Decora Smart DWIDK-1BZ, Leviton Decora DSLO6 SSL7A, Eaton Toggle TAL06P2, Legrand Adorne ADTP600RMHW1, Legrand Adorne ADTH700RMTUW1, Insteon 2477D, Control4 Decora Forward Phase C4-FPD120, Control4 Adaptive Phase C4-APD120</p>
<p>105W, 24V DC SINGLE OUTPUT TRANSFORMER L: 11" W: 4" H: 2.25" 105w, 120V Primary, 24V DC Secondary, Electronic Transformer, Black Powder Coated Enclosure, Indoor Use Only.</p> <p>98746S-12</p>	<p>Lutron Diva DVCL-153P, Lutron Skylark SCL-152P, Lutron Lumea LECL-153P, Lutron Skylark Contour CTCL-153P, Lutron Maestro MACL-153M, Lutron Sunnata STCL-153, Lutron Diva DVRP-253P, Lutron Caseta PD-6WCL, Lutron Caseta PD-5NE, Lutron Maestro MA-PRO, Lutron RadioRa 2 RRD-6NA, Lutron Maestro MRF2-6ELV, Lutron RadioRa 2 RRD-10ND, Lutron HomeWorks QS HQRD-10ND, Lutron Maestro MRF2S-6CL, Lutron RadioRa2 RRD-6CL, Lutron HomeWorks QS HQRD-6CL, Lutron HomeWorks QS HQRA-6CL, Lutron RadioRa 2 RRD-H6BRL, RadioRa 2 Hybrid Keypads, Leviton Toggle TSL06, Leviton Decora Smart DWIDK-1BZ, Leviton Decora DSLO6 SSL7A, Eaton Toggle TAL06P2, Legrand Adorne ADTP600RMHW1, Legrand Adorne ADTH700RMTUW1, Insteon 2477D, Control4 Decora Forward Phase C4-FPD120, Control4 Adaptive Phase C4-APD120</p>
<p>150W, 24V DC SINGLE OUTPUT TRANSFORMER L: 11" W: 4" H: 2.25" 150W, 120V Primary, 24V DC Secondary, Electronic Transformer, Black Powder Coated Enclosure, Indoor Use Only.</p> <p>98747S-12</p>	<p>Lutron Diva DVCL-153P, Lutron Skylark SCL-152P, Lutron Lumea LECL-153P, Lutron Skylark Contour CTCL-153P, Lutron Maestro MACL-153M, Lutron Sunnata STCL-153, Lutron Diva DVRP-253P, Lutron Caseta PD-6WCL, Lutron Caseta PD-5NE, Lutron Maestro MA-PRO, Lutron RadioRa 2 RRD-6NA, Lutron Maestro MRF2-6ELV, Lutron RadioRa 2 RRD-10ND, Lutron HomeWorks QS HQRD-10ND, Lutron Maestro MRF2S-6CL, Lutron RadioRa2 RRD-6CL, Lutron HomeWorks QS HQRD-6CL, Lutron HomeWorks QS HQRA-6CL, Lutron RadioRa 2 RRD-H6BRL, RadioRa 2 Hybrid Keypads, Leviton Toggle TSL06, Leviton Decora Smart DWIDK-1BZ, Leviton Decora DSLO6 SSL7A, Eaton Toggle TAL06P2, Legrand Adorne ADTP600RMHW1, Legrand Adorne ADTH700RMTUW1, Insteon 2477D, Control4 Decora Forward Phase C4-FPD120, Control4 Adaptive Phase C4-APD120</p>

DISK LIGHT TRANSFORMERS



Electronic Transformers

18W, 12V DC SINGLE OUTPUT TRANSFORMER

18w, 120v Primary, 12v DC Secondary, Electronic Transformer. Maximum of 4 disks. Indoor Use Only.

984218S-15

30W, 12V DC SINGLE OUTPUT TRANSFORMER

30w, 120v Primary, 12v DC Secondary, Electronic Transformer. Maximum of 8 disks. Indoor Use Only.

984230S-15

Dimming



DIMMER

Connect in the 12V DC run to dim Disk lights from 100% down to 10%. Female USB C Input to Male USB C Output.

984101S(-12 -15)



Electronic Transformer

PLUG IN POWER ADAPTOR

120V plug in transformer, 12V DC 1 Amp output for use with USB C connectors. Maximum of 8 disks.

984201S(-12 -15)

Dimming



DIMMER

Connect in the 12V DC run to dim Disk lights from 100% down to 10%. Female USB C Input to Male USB C Output.

984101S(-12 -15)

LX CABLE SYSTEMS TRANSFORMERS



Magnetic Transformers	Dimming
<p>75W, 12V DC SINGLE OUTPUT TRANSFORMER L: 8.75" W: 4.25" H: 3.35" 75w, 120v Primary, 12v DC Secondary, Electronic Transformer. Indoor Use Only.</p> <p>94458-12</p>	<p>When dimming a low-voltage system, it is recommended that the dimming occur on the primary side of the transformer, reducing the power coming into the transformer. The dimmer must be matched to the type of transformer that's powering the system.</p> <p>For Magnetic transformers, use a standard, incandescent line voltage dimmer or a magnetic low voltage (MLV) dimmer.</p>
<p>150W, 12V DC SINGLE OUTPUT TRANSFORMER L: 10.5" W: 4.3125" H: 4.3125" 150w, 120v Primary, 12v DC Secondary, Electronic Transformer. Indoor Use Only.</p> <p>94460-12</p>	
<p>300W, 12V DC SINGLE OUTPUT TRANSFORMER L: 10.5" W: 4.375" H: 3.875" 300w, 120v Primary, 12v DC Secondary, Electronic Transformer. Indoor Use Only.</p> <p>94462-12</p>	



Electronic Transformer	Dimming
<p>75W 12V ZERO-LOAD TRANSFORMER L: 7.805" W: 1.36" H: 0.949" Hardwire to power source and operate remotely or with installed switch. Secondary side features quick connection for fast install.</p> <p>96622S-12</p>	<p>When dimming a low-voltage system, it is recommended that the dimming occur on the primary side of the transformer, reducing the power coming into the transformer. The dimmer must be matched to the type of transformer that's powering the system.</p> <p>For Electronic transformers, use an electronic low voltage (ELV) Dimmer.</p>



Electronic Transformer	Dimming
<p>150W 12V ZERO-LOAD TRANSFORMER L: 8.385" W: 2.53" H: 1.219" Hardwire to power source and operate remotely or with installed switch.</p> <p>96624S-12</p>	<p>When dimming a low-voltage system, it is recommended that the dimming occur on the primary side of the transformer, reducing the power coming into the transformer. The dimmer must be matched to the type of transformer that's powering the system.</p> <p>For Electronic transformers, use an electronic low voltage (ELV) Dimmer.</p>



PRODUCT SHOWN: TRAVERSE MIRAGE IN WHITE FINISH

440 GENERATION LIGHTING

R E C E S S E D

TRAVERSE LED RECESSED



PRODUCT SHOWN: TRAVERSE MIRAGE IN WHITE FINISH

Generation Lighting has revolutionized the world of recessed downlights with our Traverse line of LED-light modules. The Traverse lineup does more than just eliminate many of the LED pain points that used to turn off consumers. It also provides you with one-stop shopping, courtesy of six different downlight options that provide superior performance and value at various price points.

Generation Lighting Traverse downlights feature advanced technology that enhances job-site productivity and efficiency with quick, easy installations. At the same time, they provide consumers with eye-pleasing, long-lasting, energy-efficient and more cost-effective LED lighting solutions. In short, the Traverse line is exactly what you'd expect from Generation Lighting, which has dominated the LED-lighting market for the last decade.



TRVERSE MIRAGE



TRVERSE AUBREY
WALL WASH



TRVERSE LOTUS



TRVERSE FLEX



TRVERSE LYTE



TRVERSE DIRECT

TRAVERSE MIRAGE RECESSED

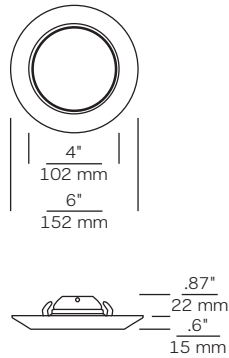

FEATURES & BENEFITS

- Recessed look and feel with unparalleled efficacy of LED
- Economical, long lasting upgrade to standard recessed lighting
- Provides visually pleasing, color accurate illumination (90 CRI)
- Dimmable down to 10%
- ENERGY STAR® Qualified
- Title-24 Compliant
- Wet Rated for shower ceiling installations
- Flat lens
- Easy to install

DIMMER COMPATIBILITY

Forbes & Lomax	FLR603P
Legrand	RHL743P
Insteon	2477D
Lutron	DVCL-153P, SCL-152P, LECL-153P, CTCL-153P, MACL-153M, STCL-153, DVRP-253P, PD-6WCL, PD-5NE, MA-PRO, RRD-6NA, MRF2-6ELV, RRD-10ND, MRF2S-6CL,
Leviton	TSL06, DW1DK-1BZ, DSL06 SSL7A, 6672, DSE06-1

SPECIFICATIONS

Item Number	14916RD-15
Item Name	TRAVERSE MIRAGE
Finish	WHITE (-15)
Color Temperature	3000K
Lumens Delivered	800
Watts Consumed	13.8
Efficacy	58
Color Rendering Index	90 CRI
Beam Spread	LAMBERTIAN
Rated Average Life	50,000 HOURS TO 70%
Dimmable	YES TO <10%
Warm On Dim	NO
Voltage	120V
Power Factor	>.9
Ambient Operating Temp.	-40°C TO +35°C
Construction	CONSTRUCTION STAMPED ALUMINUM
Lens	POLYCARBONATE
Warranty	5 YEARS
Installation	NEW CONSTRUCTION (4" ROUND, 4" SQUARE/OCTAGONAL)
Qualifications	EN+ WET T24-4

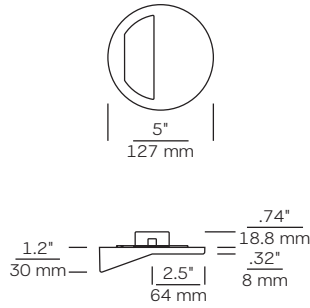

FEATURES & BENEFITS

- Designed for superior performance and value
- Economical, longer lasting alternative to standard recessed downlights
- Provides visually pleasing, color accurate illumination (90 CRI)
- ENERGY STAR® Qualified
- Title-24 Compliant
- Wet rated for shower ceiling installations
- Dimmable down to 10%
- Angled housing for optimal light performance displayed on a wall
- Easy to install

DIMMER COMPATIBILITY

Forbes & Lomax	FLR603P
Legrand	RHL743P
Insteon	2477D
Lutron	DVCL-153P, SCL-152P, LECL-153P, CTCL-153P, MACL-153M, STCL-153, DVRP-253P, PD-6WCL, PD-5NE, MA-PRO, RRD-6NA, MRF2-6ELV, RRD-10ND, MRF2S-6CL,
Leviton	TSL06, DW1DK-1BZ, DSL06 SSL7A, 6672, DSE06-1

SPECIFICATIONS

Item Number	14936RD-15
Item Name	TRAVERSE AUBREY WALL WASH
Finish	WHITE (-15)
Color Temperature	3000K
Lumens Delivered	580
Watts Consumed	10
Efficacy	58
Color Rendering Index	90 CRI
Beam Spread	LAMBERTIAN
Rated Average Life	50,000 HOURS TO 70%
Dimmable	YES TO <10%
Voltage	120V
Power Factor	>.9
Ambient Operating Temp.	-40°C TO +35°C
Lens	POLYCARBONATE
Warranty	5 YEARS
Installation	NEW CONSTRUCTION (3"/4" ROUND, 4" SQUARE/OCTAGONAL)
Qualifications	EN* WET T24-4

TRAVERSE LOTUS RECESSED

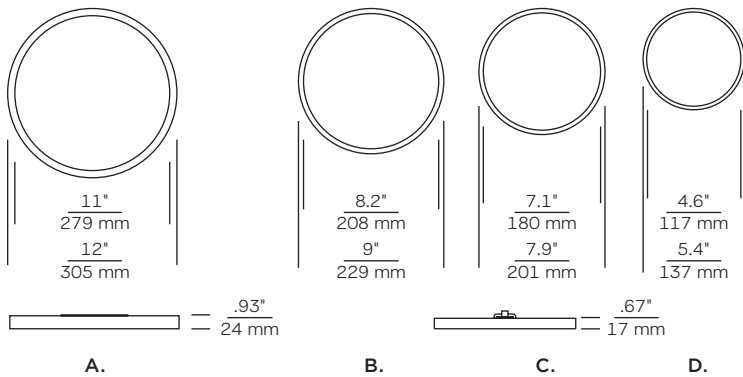
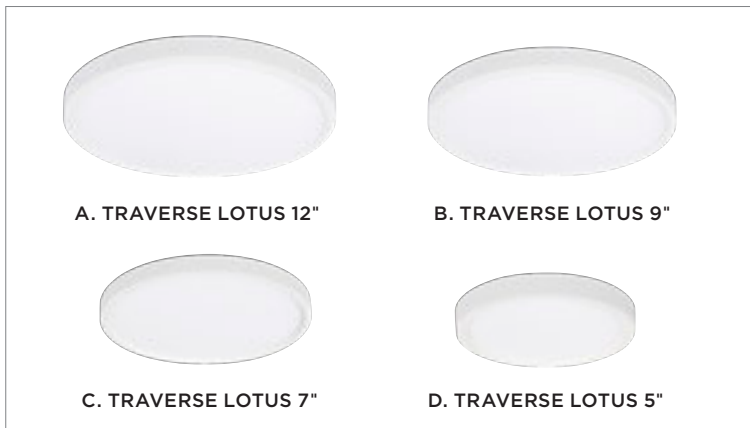

FEATURES & BENEFITS

- Designed for superior performance and value
- Economical, longer lasting alternative to standard recessed downlights
- Provides visually pleasing, color accurate illumination (90 CRI)
- Easy to install:
 - Standard 120V lighting fixture
 - Mounts on all standard junction boxes, including pan junction box
- ENERGY STAR® qualified
- Title-24 Compliant
- Wet rated for shower ceiling Installations
- Dimmable down to 10%

DIMMER COMPATIBILITY

Forbes & Lomax	FLR603P
Legrand	RHL743P
Insteon	2477D
Lutron	DVCL-153P, SCL-152P, LECL-153P, CTCL-153P, MACL-153M, STCL-153, DVVP-253P, PD-6WCL, PD-5NE, MA-PRO, RRD-6NA, MRF2-6ELV, RRD-10ND, MRF2S-6CL,
Leviton	TSL06, DWIDK-1BZ, DSL06 SSL7A, 6672, DSE06-1

SPECIFICATIONS

Item Number	149212RD-15	14929RD-15	14827RD-15	14825RD-15
Item Name	A. TRAVERSE LOTUS 12" ROUND	B. TRAVERSE LOTUS 9" ROUND	C. TRAVERSE LOTUS 7" ROUND	D. TRAVERSE LOTUS 5" ROUND
Finish	WHITE (-15)	WHITE (-15)	WHITE (-15)	WHITE (-15)
Color Temperature	3000K	3000K	3000K	3000K
Lumens Delivered	1400	1150	850	550
Watts Consumed	22 WATTS	18 WATTS	15 WATTS	10 WATTS
Efficacy	64 LM/W	64 LM/W	57 LM/W	55 LM/W
Color Rendering Index	90 CRI	90 CRI	90 CRI	90 CRI
Beam Spread	LAMBERTIAN	LAMBERTIAN	LAMBERTIAN	LAMBERTIAN
Rated Average Life	50,000 HOURS TO 70%	50,000 HOURS TO 70%	50,000 HOURS TO 70%	50,000 HOURS TO 70%
Dimmable	YES TO 10%	YES TO <10%	YES TO <10%	YES TO <10%
Voltage	120V	120V	120V	120V
Power Factor	>.9	>.9	>.9	>.9
Ambient Operating Temp.	-20°C TO +45°C	-20°C TO +45°C	-20°C TO +45°C	-20°C TO +45°C
Lens	POLYCARBONATE	POLYCARBONATE	POLYCARBONATE	POLYCARBONATE
Warranty	5 YEARS	5 YEARS	5 YEARS	5 YEARS
Installation	NEW CONSTRUCTION (3 1/4" ROUND, 4" SQUARE/OCTAGONAL, 4" PANCAKE)	NEW CONSTRUCTION (3 1/4" ROUND, 4" SQUARE/OCTAGONAL, 4" PANCAKE)	NEW CONSTRUCTION (3 1/4" ROUND, 4" SQUARE/OCTAGONAL, 4" PANCAKE)	NEW CONSTRUCTION (3 1/4" ROUND, 4" SQUARE/OCTAGONAL, 4" PANCAKE)
Qualifications	EN ★ WET T24-4	EN ★ WET T24-4	EN ★ WET T24-4	EN ★ WET T24-4

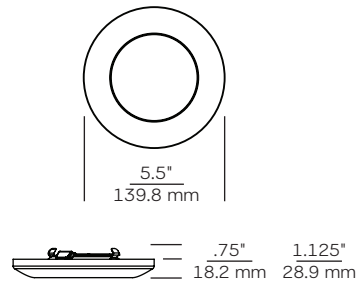

FEATURES & BENEFITS

- Designed for superior performance and value
- Economical, longer lasting alternative to standard recessed downlights
- Provides visually pleasing, color accurate illumination (90 CRI)
- Easy to install: uses mounting ring, trim snaps into ring with springs
- Standard 120V lighting fixture
- Mounts to 4" junction boxes, including pancake junction box
- ENERGY STAR® qualified
- Title-24 Compliant
- Wet rated for shower ceiling installations
- Dimmable down to 3%

DIMMER COMPATIBILITY

Forbes & Lomax	FLR603P
Legrand	RHL743P
Insteon	2477D
Lutron	DVCL-153P, SCL-152P, LECL-153P, CTCL-153P, MACL-153M, STCL-153, DVRP-253P, PD-6WCL, PD-5NE, MA-PRO, RRD-6NA, MRF2-6ELV, RRD-10ND, MRF2S-6CL,
Leviton	TSL06, DWIDK-1BZ, DSL06 SSL7A, 6672, DSE06-1

SPECIFICATIONS

Item Number	14620S-15
Item Name	TRAVERSE FLEX
Finish	WHITE (-15)
Color Temperature	3000K
Lumens Delivered	850
Watts Consumed	13 WATTS
Efficacy	65 LM/W
Color Rendering Index	90 CRI
Beam Spread	LAMBERTIAN
Rated Average Life	50,000 HOURS TO 70%
Dimmable	YES TO 3%
Warm On Dim	YES
Voltage	120V
Power Factor	>.9
Ambient Operating Temp.	-40°C TO +35°C
Construction	STAMPED ALUMINUM, POWDER COATED
Lens	POLYCARBONATE SNAP IN
Warranty	5 YEARS
Installation	NEW CONSTRUCTION ON 4" ROUND OR OCTAGONAL JUNCTION BOX, 4" PANCAKE
Qualifications	EN* WET T24-4

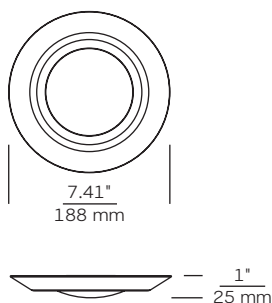

FEATURES & BENEFITS

- Designed for superior performance and value
- Economical, longer lasting alternative to standard recessed downlights
- Provides visually pleasing, color accurate illumination (90 CRI)
- Easy to install:
 - Standard 120V lighting fixture
 - Mounts on all standard junction boxes, including pancake junction box
- Retrofits into most common recessed lighting housings with optional Edison base adapter (5" and 6" uses part #14795)
- ENERGY STAR® qualified
- Title-24 Compliant
- Wet rated for shower ceiling installations
- Dimmable down to 5%

DIMMER COMPATIBILITY

Forbes & Lomax	FLR603P
Legrand	RHL743P
Insteon	2477D
Lutron	DVCL-153P, SCL-152P, LECL-153P, CTCL-153P, MACL-153M, STCL-153, DVRP-253P, PD-6WCL, PD-5NE, MA-PRO, RRD-6NA, MRF2-6ELV, RRD-10ND, MRF2S-6CL,
Leviton	TSL06, DW1DK-1BZ, DSL06 SSL7A, 6672, DSE06-1

SPECIFICATIONS

Item Number	14550S-15
Item Name	TRAVERSE LYTE
Finish	WHITE (-15)
Color Temperature	3000K
Lumens Delivered	850
Watts Consumed	13
Efficacy	65 LM/W
Color Rendering Index	90 CRI
Beam Spread	LAMBERTIAN
Rated Average Life	50,000 HOURS TO 70%
Dimmable	YES TO <5%
Voltage	120V
Power Factor	>.9
Ambient Operating Temp.	-40°C TO +35°C
Construction	STAMPED ALUMINUM, POWDER COATED
Lens	POLYCARBONATE
Warranty	5 YEARS
Installation	NEW CONSTRUCTION ON 3" AND 4" ROUND JUNCTION BOXES, 4" SQUARE / OCTAGON. RETROFIT REQUIRES 14795, 4" PANCAKE
Qualifications	EN* WET T24-4

RECESSED HOUSING COMPATIBILITY

All-Pro	EI500AT, EI500RAT, ET500, ET500R, EI700AT, EI700RAT, EI700ATNB, EI700, EI700R, EI700NB, ET700, ET700R, EI700U, EI700UAT, EI2700AT, EI2700, ET2700, ET2700R
Capri	CR1, PR1, QL1, R9ASIC
Commercial Electric	H3, H17, H18
Elco	EL71CA
Halo	H71CAT, H7RICAT, H7ICT, H7RICT, H7ICATNB, H7ICTNB, H7T, H7RT, H7TNB, H7TCP, H7UIC, H7UICAT, H271CAT, H27RICAT, H27ICT, H27RICT, H27T, H27RT, H51CAT, H5RICAT, H5T, H5RT, H251CAT
Juno	ICC22/R/W/S, IC23/W, IC21/R, TC2/R, IC20, IC25/W/S, TC20
Lightolier	11041CS/ICR/SIC/SICR, 11041CX (WITH ML7RAB HOUSING ADAPTER)
Lithonia Lighting	L7X, L7XP
Prescolite	IBXS
Progress	P87 (WITH ML7RAB HOUSING ADAPTER). REQUIRES MOUNTING CLIP ACCESSORY (SOLD SEPARATELY). CONSULT FACTORY FOR DETAILS.
Generation Lighting	1128, 1128QC, 11028, 11028QC, 11128, 11128QC, 11118, 11018, 1128FB
Thomas	PS1, PS9RM

OPTIONAL RETROFIT KIT



14795
For housings with or without integral "C" clips

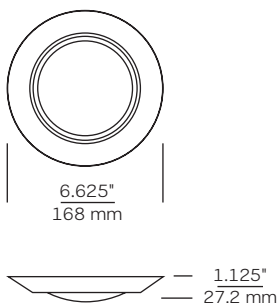

FEATURES & BENEFITS

- Designed for superior performance and value
- Economical, longer lasting alternative to standard recessed downlights
- Provides visually pleasing, color accurate illumination (90 CRI)
- Easy to install: mounts directly to j-box without a mounting ring
- Standard 120V lighting fixture
- Mounts on all Standard junction boxes, including pancake junction box
- ENERGY STAR® qualified
- Title-24 Compliant
- Wet rated for shower ceiling installations when adding silicone around trim
- Dimmable down to 3%

DIMMER COMPATIBILITY

Forbes & Lomax	FLR603P
Legrand	RHL743P
Insteon	2477D
Lutron	DVCL-153P, SCL-152P, LECL-153P, CTCL-153P, MACL-153M, STCL-153, DVRP-253P, PD-6WCL, PD-5NE, MA-PRO, RRD-6NA, MRF2-6ELV, RRD-10ND, MRF2S-6CL,
Leviton	TSL06, DW1DK-1BZ, DSL06 SSL7A, 6672, DSE06-1

SPECIFICATIONS

Item Number	14210S-15
Item Name	TRVERSE DIRECT
Finish	WHITE (-15)
Color Temperature	3000K
Lumens Delivered	850
Watts Consumed	11.4 WATTS
Efficacy	75 LM/W
Color Rendering Index	90 CRI
Beam Spread	LAMBERTIAN
Rated Average Life	50,000 HOURS TO 70%
Dimmable	YES TO 3%
Warm On Dim	YES
Voltage	120V
Power Factor	>.9
Ambient Operating Temp.	-40°C TO +35°C
Construction	STAMPED ALUMINUM, POWDER COATED
Lens	POLYCARBONATE
Warranty	5 YEARS
Installation	REMOVABLE LENS FOR FLEXIBLE INSTALLATION, NEW CONSTRUCTION ON 3" AND 4" ROUND JUNCTIONS BOXES, 4" SQUARE/OCTAGONAL, RETROFIT REQUIRES 14795, 4" PANCAKE, DIRECT MOUNT TO JUNCTION BOX
Qualifications	EN * WET T24-4

RECESSED HOUSING



PRODUCT SHOWN: 4" HOUSING WITH MULTIPLIER TRIM, WHITE

Selecting the right recessed housing begins with knowing the Installation method as well as understanding how the space will be used. The guide below will help you with the process of selecting your housing.

REMODEL OR NEW CONSTRUCTION

A “remodel” Installation typically is an existing room project where the Installation is made by cutting through existing ceiling materials. The housing will not be supported by joists but by the ceiling material, such as drywall.

A “new construction” project is one that has access to the ceiling and joists; where insulation and drywall are not yet installed. New construction housings are nailed directly into the joists with adjustable bar hangers.

IC OR NON-IC HOUSING

IC (insulation contact) housings can come in direct contact with insulation materials. Insulation should not be compressed.

Non-IC (no insulation contact) housings are for areas without insulation or where insulation can be kept a minimum of 3" away from housing.

SIZE OF HOUSING

4" housings are designed for a smaller, sleek look in your ceiling. Best used in smaller spaces for a minimal look.

6" housings are for the standard large aperture approach in your ceiling. Can be used in tall entryways and two-story hallways or high ceilings.

ADDITIONAL CONSIDERATIONS

AIR-TIGHT HOUSINGS are sealed to prevent air from escaping into the ceiling / floor above; a benefit to heating /cooling efficiency.

A RECESSED TRIM is the “ring” blending the recessed housing, lamp and ceiling material into a clean finish.

A BAFFLE is the cone-like piece that surrounds the inside of the housing around the bulb; they can be smooth or ridged and help shape the light and minimize glare.



4" HOUSING 1115

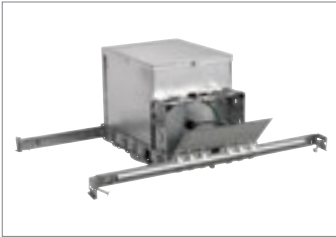

4" HOUSING 1179



6" HOUSING 1128 & 1128QC

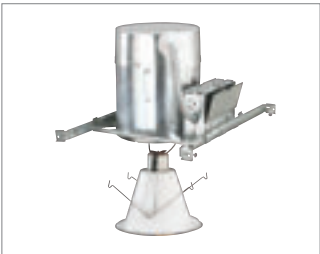

6" HOUSING 11028QC



6" HOUSING 10119



6" HOUSING 10118



6" HOUSING 1109

RECESSED HOUSING



PRODUCT SHOWN: 4" HOUSING WITH MULTIPLIER TRIM, WHITE



Adjustable socket assembly provides flexibility in lamping options.

Housing removable for easy access to junction box.

Provided with mounting clips for fast, easy installation.

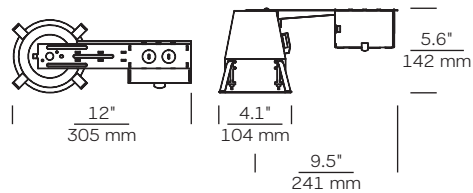

1115
Remodel / Non-IC

Safe - thermally protected, listed for damp location

Non-IC housings approved for use at least 3" away from insulation.

Junction box

Features snap-on covers, pry-out knockouts, riveted ground Wire, and through-circuit wiring, with 2-in/2-out #12 Wire.



White Finish (-15)
White Frosted Glass

4" SHOWER TRIM

(1) Medium Base
PAR20 35w max.

WET
1152AT-15



White Finish (-15)
Clear Fresnel Glass

4" SHOWER TRIM

(1) Medium Base
PAR20 35w max.

WET
1153AT-15



White Trim / Baffle (-14)

4" BAFFLE TRIM

(1) Medium Base
PAR20 50w max.

DAMP
1156AT-14



White Finish (-15)

4" EYEBALL TRIM

(1) Medium Base
PAR20 50w max.

DAMP
1166AT-15



White Trim / Baffle (-14)

4" MULTIPLIER TRIM

(1) Medium Base
PAR20 50w max.

DAMP
1162AT-14

4" HOUSING 1179 RECESSED

New Construction / IC Airtight

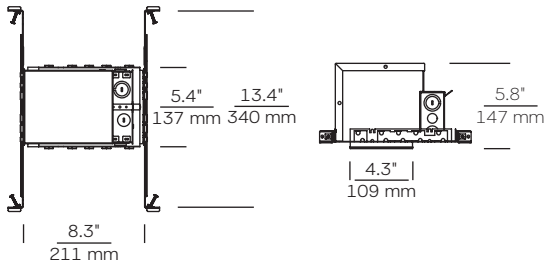
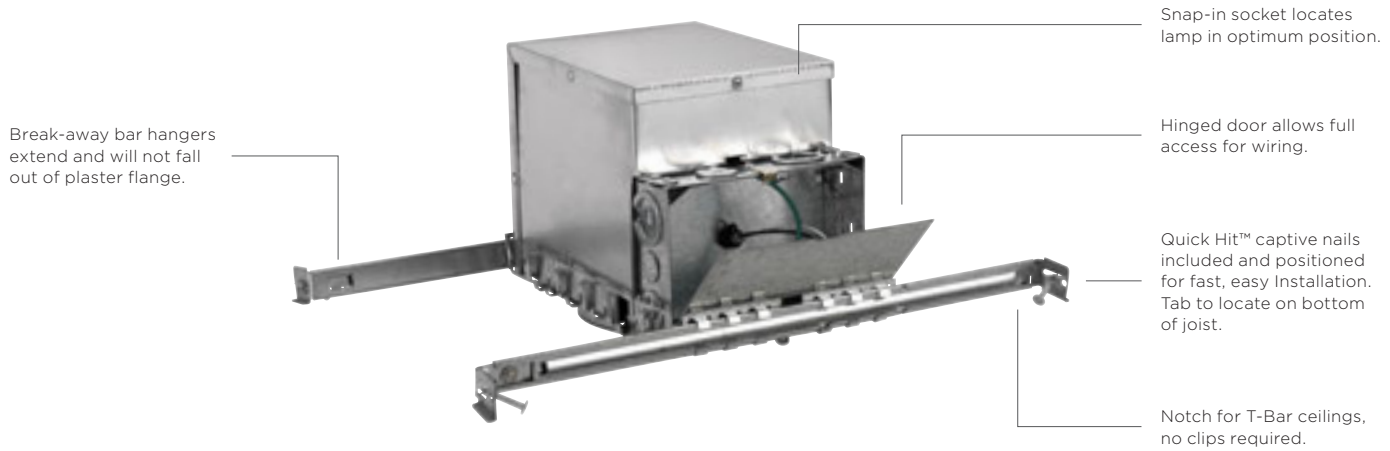

1179
New Construction / IC Airtight

Airtight construction

Meets airtight requirements for 2.0 CFM or less air leakage.

Safe - thermally protected, listed for damp location

IC housings approved for use in direct contact with insulation.

Adjustable housing

Housing adjusts vertically for various ceiling thicknesses.

Junction box

Features snap-on covers, pry-out knockouts, riveted ground Wire, and through-circuit wiring, with 2-in/2-out #12 Wire.



White Finish (-15)
White Frosted Glass

4" SHOWER TRIM

(1) Medium Base
PAR20 35w max.

WET
1152AT-15



White Finish (-15)
Clear Fresnel Glass

4" SHOWER TRIM

(1) Medium Base
PAR20 35w max.

WET
1153AT-15



White Trim / Baffle (-14)

4" BAFFLE TRIM

(1) Medium Base
PAR20 50w max.

DAMP
1156AT-14



White Finish (-15)

4" EYEBALL TRIM

(1) Medium Base
PAR20 50w max.

DAMP
1166AT-15



White Trim / Baffle (-14)

4" MULTIPLIER TRIM

(1) Medium Base
PAR20 50w max.

DAMP
1162AT-14

New Construction / IC Airtight

Adjustable socket assembly provides flexibility in lamping options.

Notch for T-Bar ceilings, no clips required.

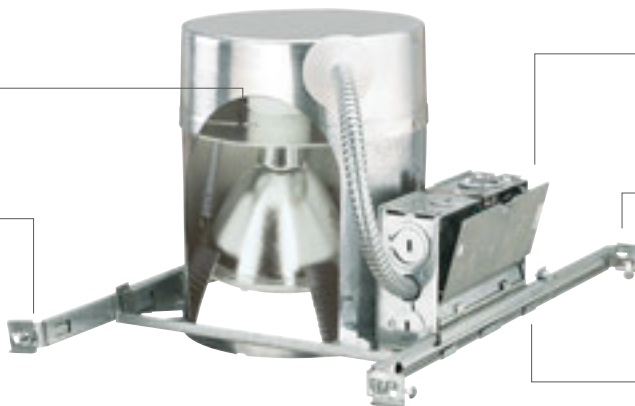

Hinged door allows full access for wiring.

Quick Hit™ captive nails included and positioned for fast, easy installation. Tab to locate on bottom of joist.

Break-away bar hangers extend and will not fall out of plaster flange.

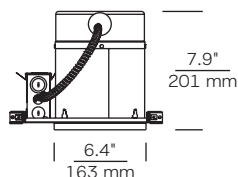
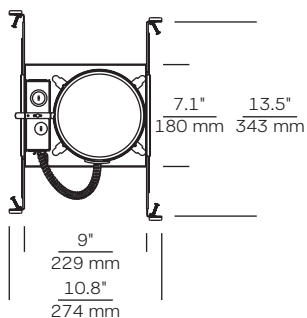

1128
New Construction / IC Airtight

Airtight Construction

Meets airtight requirements for 2.0 CFM or less air leakage.

Safe - thermally protected, listed for damp location

IC housings approved for use in direct contact with insulation.

Adjustable housing

Housing adjusts vertically for various ceiling thicknesses.

Junction box with integral Romex connector

Features quick-push and lock connector and through-circuit wiring with 4-in/4-out #12 Wire.

Quick Connectors

QC models come with quick connect Wire connectors for fast connections to house Wire.



White Trim / Baffle (-14)

6" BAFFLE TRIM

- (1) Medium Base PAR30L 75W max.
- (1) Medium Base PAR30S 50w max.
- (1) Medium Base BR30 65w max.

DAMP
1126-14



White Deep Cone Baffle (-14)

6" BAFFLE TRIM

- (1) Medium Base PAR30L 75W max.
- (1) Medium Base PAR30S 50w max.
- (1) Medium Base BR30 65w max.

DAMP
1151AT-14



White Aluminum Ring (-15)
Clear Fresnel Glass

6" SHOWER TRIM

- (1) Medium Base 40w max.

WET
1155AT-15



White Deep Cone Baffle (-14)

6" OPEN SHOWER TRIM

- (1) Medium Base PAR30L 75W max.
- (1) Medium Base PAR30S 50w max.
- (1) Medium Base PAR38 90w max.

WET
1154AT-14



White Aluminum Ring (-15)
White Glass Diffuser

6" SHOWER TRIM

- (1) Medium Base 40w max.

WET
1133AT-15

6" HOUSING 11028QC RECESSED

New Construction / IC Airtight

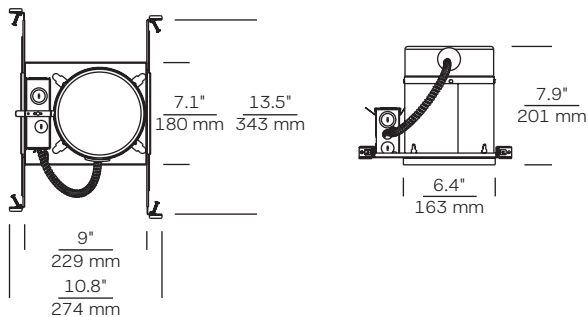
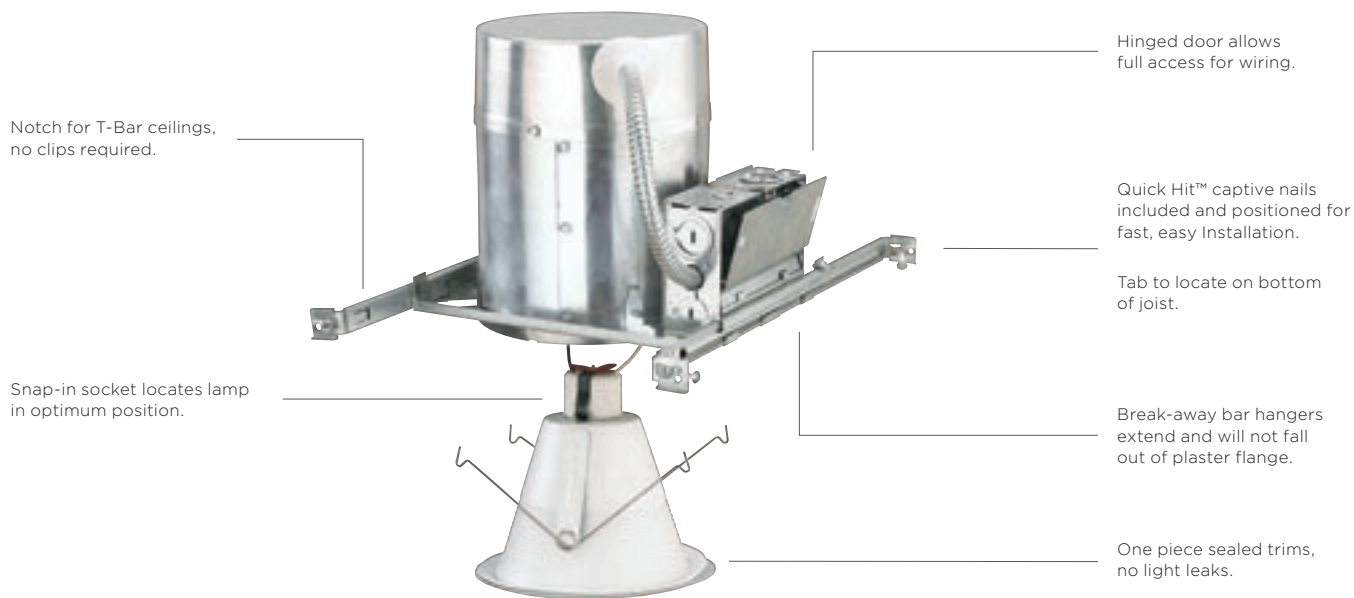

11028QC
New Construction / IC Airtight

Airtight Construction

Meets airtight requirements for 2.0 CFM or less air leakage.

Safe - thermally protected, listed for damp location

IC housings approved for use in direct contact with insulation.

Adjustable housing

Housing adjusts vertically for various ceiling thicknesses.

Junction box with integral Romex connector

Features quick-push and lock connector and through-circuit wiring with 4-in/4-out #12 Wire.

Quick Connectors

QC models come with quick connect Wire connectors for fast connections to house Wire.



White Aluminum Ring (-15)
White Glass Diffuser

6" FLAT GLASS SHOWER TRIM

(1) Medium Base
40w max.

WET
11033AT-15



White Deep Cone Baffle (-14)

6" OPEN SHOWER TRIM

(1) Medium Base
PAR30L 75W max.
(1) Medium Base
PAR30S 50w max.
(1) Medium Base
PAR38 90w max.

WET
1154AT-14



White Deep Cone Baffle (-14)

6" BAFFLE TRIM

(1) Medium Base
PAR30L 75W max.
(1) Medium Base
PAR30S 50w max.
(1) Medium Base
BR30 65w max.
(1) Medium Base
PAR38 90w max.

DAMP
1151AT-14

New Construction / IC / Shallow Airtight

Remodel / IC Airtight

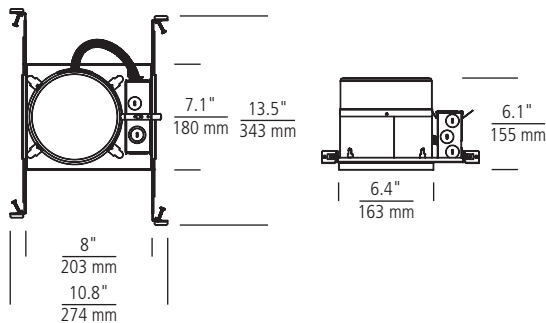
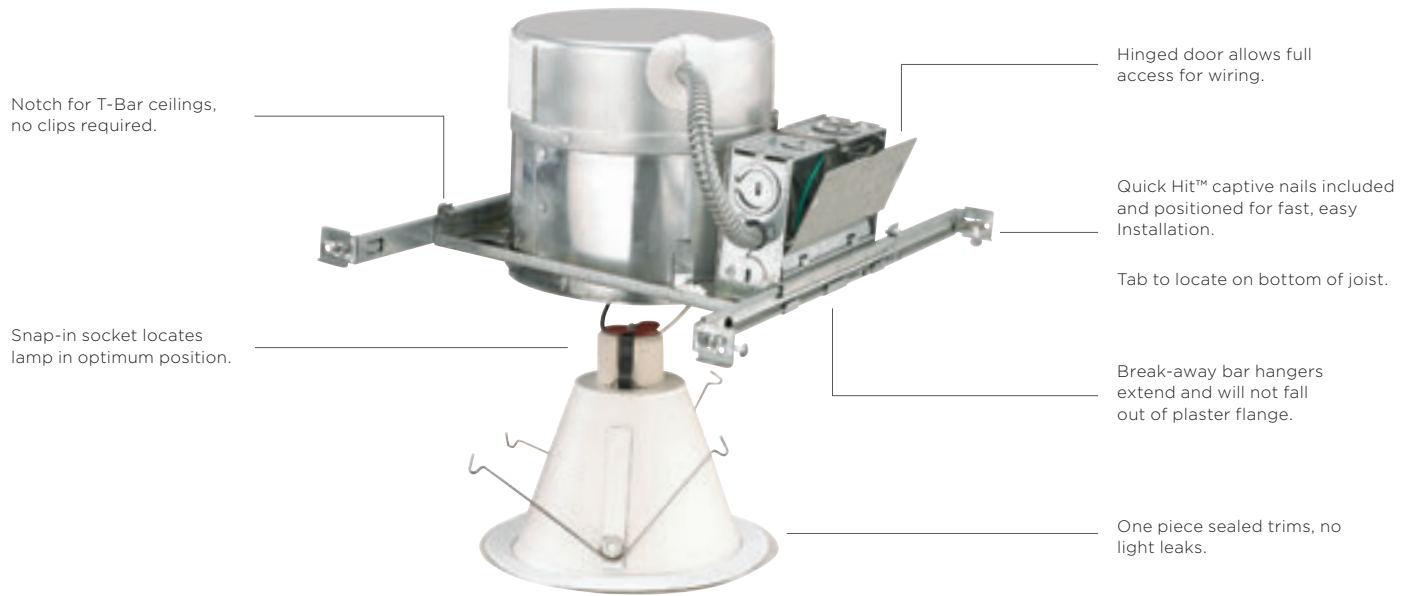

11019
New Construction / IC / Shallow Airtight

Airtight Construction

Meets airtight requirements for 2.0 CFM or less air leakage.

Safe - thermally protected, listed for damp location

IC housings approved for use in direct contact with insulation.

Adjustable Housing

Housing adjusts vertically for various ceiling thicknesses

Junction box

Features quick-push and lock connector and through-circuit wiring with 4in/4-out #12 Wire.



White Deep Cone Baffle (-14)

6" BAFFLE TRIM

- (1) Medium Base PAR30L 75W max.
- (1) Medium Base PAR30S 50w max.
- (1) Medium Base BR30 65w max.

WET
1158AT-14



White Aluminum Ring (-15)
White Glass Diffuser

6" FLAT GLASS SHOWER TRIM

- (1) Medium Base 40w max.

WET
11033AT-15

6" HOUSING 11018

RECESSED

Remodel / IC Airtight

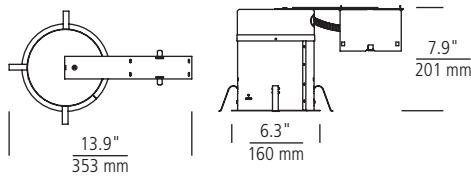
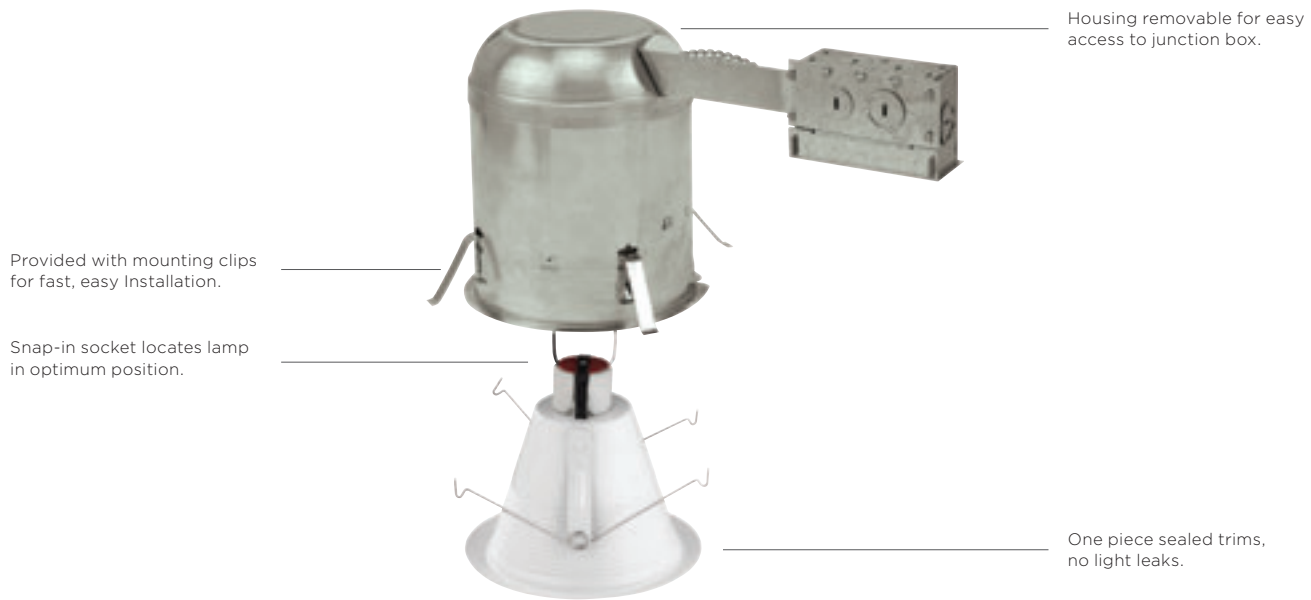

11018
Remodel / IC Airtight

Airtight Construction

Meets airtight requirements for 2.0 CFM or less air leakage.

Safe - thermally protected, listed for damp location

IC housings approved for use in direct contact with insulation.

Fast, easy installation

Provided with mounting clips

Junction box

Features snap-on covers, pry-out knockouts, riveted ground Wire, and through-circuit wiring, with 2-in/2-out #12 Wire.



White Aluminum Ring (-15)
White Fresnel Glass Diffuser

6" FLAT GLASS SHOWER TRIM

(1) Medium Base
40w max.

WET
11033AT-15



White Deep Cone Baffle
(-14)

6" BAFFLE TRIM

(1) Medium Base
PAR30L 75W max.
(1) Medium Base
PAR30S 50w max.
(1) Medium Base
BR30 65w max.
(1) Medium Base
PAR38 90w max.

DAMP
1151AT-14



White Deep Cone Baffle
(-14)

6" OPEN SHOWER TRIM

(1) Medium Base
PAR30L 75W
max.
(1) Medium Base
PAR30S 50w
max.
(1) Medium Base
PAR38 90w max.

WET
1154AT-14

New Construction / IC Airtight / Sloped Ceiling

Adjustable socket assembly provides flexibility in lighting options.

Break-away bar hangers extend and will not fall out of plaster flange.

Designed to fit ceiling slopes of 15° to 45°.



Quick Hit™ captive nails included and positioned for fast, easy installation.

Tab to locate on bottom of joist.

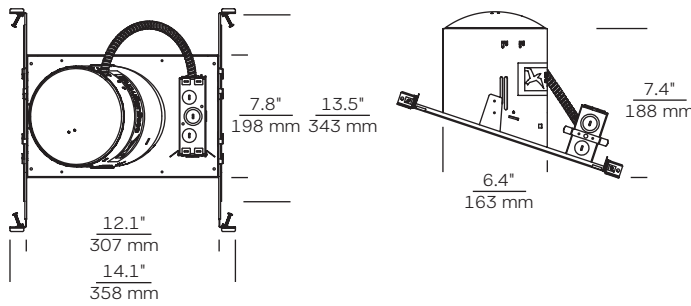

Airtight Construction

Meets airtight requirements for 2.0 CFM or less air leakage.

Safe - thermally protected, listed for damp location
 IC housings approved for use in direct contact with insulation.

Adjustable Housing

Housing adjusts vertically for various ceiling thicknesses

Junction box

Features quick-push and lock connector and through-circuit wiring with 4in/4-out #12 Wire.

1109
 New Construction / IC Airtight / Sloped Ceiling



White Trim / Baffle (-14)

6" SLOPED TRIM

(1) Medium Base
 PAR38 75W max.

DAMP
1121-14



PRODUCT SHOWN: ALTURAS NINE LIGHT
CHANDELIER IN BRUSHED NICKEL FINISH

480 GENERATION LIGHTING

BUILDER SERIES



PRODUCT SHOWN: ALTURAS FIVE LIGHT
CHANDELIER IN SATIN BRASS FINISH

A. LARGE NINE LIGHT CHANDELIER

D: 32.5" H: 32.75"
12' Wire, (3) 12" Stems, (1) 6" Stem
Sloped Ceiling Mounting Hardware incl.
DAMP

3124609(-848 -962 -112)

(9) Medium Base 60W max.
T24-1

3124609EN3(-848 -962 -112)

(9) Med. Base LED 3000K,
9W, 800 Lumen lamps incl.
T24-2 EN*

B. MEDIUM FIVE LIGHT CHANDELIER

D: 27.25" H: 27"
12' Wire, (3) 12" Stems, (1) 6" Stem
Sloped Ceiling Mounting Hardware incl.
DAMP

3124605(-848 -962 -112)

(5) Medium Base 75W max.
T24-1

3124605EN3(-848 -962 -112)

(5) Med. Base LED 3000K,
9W, 800 Lumen lamps incl.
T24-2 EN*

C. SMALL THREE LIGHT CHANDELIER

D: 19" H: 18.75"
12' Wire, (3) 12" Stems, (1) 6" Stem
Sloped Ceiling Mounting Hardware incl.
DAMP

3124603(-848 -962 -112)

(3) Medium Base 75W max.
T24-1

3124603EN3(-848 -962 -112)

(3) Med. Base LED 3000K,
9W, 800 Lumen lamps incl.
T24-2 EN*



A

Midnight Black Finish (-112)
Opal Etched Glass Shades



B

Brushed Nickel Finish (-962)
Opal Etched Glass Shades



C

Satin Brass Finish (-848)
Opal Etched Glass Shades

FINISH CODES

- (-848) Satin Brass
- (-962) Brushed Nickel
- (-112) Midnight Black

**D. LARGE NINE LIGHT
CHANDELIER**

D: 32.5" H: 32.75"
12' Wire, (3) 12" Stems, (1) 6" Stem

DAMP

3124679(-112 -848 -962)

(9) Medium Base 60W max.

T24-1

3124679EN7(-112 -848 -962)

(9) Med. Base LED 2700K,
8W, 800 Lumens lamps incl.

T24-2



D

Midnight Black Finish (-112)
Clear Seeded Glass Shades



Satin Brass Finish (-848)
Clear Seeded Glass Shades

FINISH CODES

- (-112) Midnight Black
- (-848) Satin Brass
- (-962) Brushed Nickel

E. MEDIUM FIVE LIGHT CHANDELIER

D: 27.25" H: 27"
12' Wire, (3) 12" Stems, (1) 6" Stem
DAMP

3124675(-112 -848 -962)
(5) Medium Base 75W max.
T24-1

3124675EN7(-112 -848 -962)
(5) Med. Base LED 2700K,
8W, 800 Lumens lamps incl.
T24-2 EN*



E

Midnight Black Finish (-112)
Clear Seeded Glass Shades

F. SMALL THREE LIGHT CHANDELIER

D: 19" H: 18.75"
12' Wire, (3) 12" Stems, (1) 6" Stem
DAMP

3124673(-112 -848 -962)
(3) Medium Base 75W max.
T24-1

3124673EN7(-112 -848 -962)
(3) Med. Base LED 2700K,
8W, 800 Lumens lamps incl.
T24-2 EN*



F

Brushed Nickel Finish (-962)
Clear Seeded Glass Shades



Satin Brass Finish (-848)
Clear Seeded Glass Shades

FINISH CODES

- (-112) Midnight Black
- (-848) Satin Brass
- (-962) Brushed Nickel

G. MEDIUM THREE LIGHT PENDANT

D: 19" H: 18.75"
 12' Wire, (3) 12" Stems, (1) 6" Stem
 Sloped Ceiling Mounting Hardware incl.

DAMP

6624603(-848 -962 -112)

(3) Medium Base 75W max.

T24-1

6624603EN3(-848 -962 -112)

(3) Med. Base LED 3000K,
 9W, 800 Lumen lamps incl.

T24-2 EN*

H. ONE LIGHT MINI-PENDANT

D: 3.5" H: 7.25"
 12' Wire, (3) 12" Stems, (1) 6" Stem
 Sloped Ceiling Mounting Hardware incl.

DAMP

6124601(-848 -962 -112)

(1) Medium Base 75W max.

T24-1

6124601EN3(-848 -962 -112)

(1) Med. Base LED 3000K,
 9W, 800 Lumen lamp incl.

T24-2 EN*

I. MEDIUM TWO LIGHT SEMI-FLUSH CONVERTIBLE PENDANT

D: 14" H: 16.375" Semi-Flush H: 14.875"
 6' Wire pre-laced through 3' Chain

DAMP +

7724602(-848 -962 -112)

(2) Medium Base 60W max.

T24-1

7724602EN3(-848 -962 -112)

(2) Med. Base LED 3000K,
 9.3W, 800 Lumen lamps incl.

T24-2 EN*



G

Satin Brass Finish (-848)
 Opal Etched Glass



H

Midnight Black Finish (-112)
 Etched, White Glass



I

Brushed Nickel Finish (-962)
 Opal Etched Glass

FINISH CODES

- (-848) Satin Brass
- (-962) Brushed Nickel
- (-112) Midnight Black

J. FOUR LIGHT WALL / BATH

W: 30.5" H: 9.25" E: 7.25"
 Height from center of outlet box
 up: 6.25" down: 3"

DAMP +

4424604(-05 -848 -962 -778 -112)

(4) Medium Base 75W max.

T24-1

4424604EN3(-05 -848 -962 -778 -112)

(4) Med. Base LED 3000K,
 9W, 800 Lumen lamp incl.

T24-2 EN*



J

Chrome Finish (-05)
 Etched, White Inside Glass

K. THREE LIGHT WALL / BATH

W: 22" H: 9.25" E: 7.5"
 Height from center of outlet box
 up: 6.25" down: 3"

DAMP +

4424603(-05 -848 -962 -778 -112)

(3) Medium Base 75W max.

T24-1

4424603EN3(-05 -848 -962 -778 -112)

(3) Med. Base LED 3000K,
 9W, 800 Lumen lamp incl.

T24-2 EN*



K

Satin Brass Finish (-848)
 Etched, White Inside Glass

L. TWO LIGHT WALL / BATH

W: 13.5" H: 9.25" E: 6.5"
 Height from center of outlet box
 up: 6.25" down: 3"

DAMP +

4424602(-05 -848 -962 -778 -112)

(2) Medium Base 75W max.

T24-1

4424602EN3(-05 -848 -962 -778 -112)

(2) Med. Base LED 3000K,
 9W, 800 Lumen lamp incl.

T24-2 EN*



L

Brushed Nickel Finish (-962)
 Etched, White Inside Glass



Midnight Black Finish (-112)
 Etched, White Inside Glass

M. ONE LIGHT WALL / BATH SCONCE

W: 4.5" H: 8.75" E: 6.25"
 Height from center of outlet box
 up: 5.75" down: 3"

DAMP +

4124601(-05 -848 -962 -778 -112)

(1) Medium Base 75W max.

T24-1

4124601EN3(-05 -848 -962 -778 -112)

(1) Med. Base LED 3000K,
 9W, 800 Lumen lamp incl.

T24-2 EN*



M

Pewter Bronze Finish (-778)
 Etched, White Inside Glass

FINISH CODES

- (-05) Chrome
- (-848) Satin Brass
- (-962) Brushed Nickel
- (-778) Pewter Bronze
- (-112) Midnight Black



PRODUCT SHOWN: OSLO NINE LIGHT
CHANDELIER IN BRUSHED NICKEL FINISH

A. LARGE NINE LIGHT CHANDELIER

D: 26" H: 26.75"
12' Wire pre-laced through 10' Chain

31162(-05 -962 -112)
(9) Medium Base 60W max.
T24-1

31162EN3(-05 -962 -112)
(9) Med. Base LED 3000K,
9W, 800 Lumen lamps incl.
T24-2 EN*

B. MEDIUM FIVE LIGHT CHANDELIER

D: 24" H: 20" Downlight H: 27"
12' Wire pre-laced through 10' Chain



31161(-05 -962 -112)
(5) Medium Base 75W max.
T24-1

31161EN3(-05 -962 -112)
(5) Med. Base LED 3000K,
9W, 800 Lumen lamps incl.
T24-2 EN*

C. SMALL THREE LIGHT CHANDELIER

D: 15" H: 16.5" Downlight H: 22"
12' Wire pre-laced through 10' Chain



31160(-05 -962 -112)
(3) Medium Base 75W max.
T24-1

31160EN3(-05 -962 -112)
(3) Med. Base LED 3000K,
9W, 800 Lumen lamps incl.
T24-2 EN*



A
Chrome Finish (-05)
Cased Opal Etched Glass



B
Brushed Nickel Finish (-962)
Cased Opal Etched Glass



C
Midnight Black Finish (-112)
Cased Opal Etched Glass

FINISH CODES

- (-05) Chrome
- (-962) Brushed Nickel
- (-112) Midnight Black

D. MEDIUM THREE LIGHT LINEAR CHANDELIER

L: 25.25" W: 4" H: 9.5"
12' Wire, (6) 12" Stems, (2) 6" Stems

66160(-05 -962 -112)
(3) Medium Base 75W max.
T24-1

66160EN3(-05 -962 -112)
(3) Med. Base LED 3000K,
9W, 800 Lumen lamps incl.
T24-2 EN*



D

Brushed Nickel (-962)
Cased Opal Etched Glass



F

Midnight Black (-112)
Cased Opal Etched Glass

E. MEDIUM ONE LIGHT PENDANT

D: 15.75" H: 8.75"
12' Wire pre-laced through 10' Chain

65160(-05 -962 -112)
(1) Medium Base 150W max.
T24-1

65160EN3(-05 -962 -112)
(1) Med. Base LED 3000K,
9W, 800 Lumen lamp incl.
T24-2 EN*

F. ONE LIGHT MINI-PENDANT

D: 4" H: 5.75"
10' Wire, (3) 12" Stems, (1) 6" Stem
Sloped Ceiling Mounting Hardware incl.

61160(-05 -962 -112)
(1) Medium Base 75W max.
T24-1

61160EN3(-05 -962 -112)
(1) Med. Base LED 3000K,
9W, 800 Lumen lamp incl.
T24-2 EN*

G. MEDIUM TWO LIGHT SEMI FLUSH CONVERTIBLE PENDANT

D: 13.5" H: 11.25" Semi-Flush H: 10"
12' Wire pre-laced through 10' Chain

77160(-05 -962 -112)
(2) Medium Base 75W max.
T24-1

77160EN3(-05 -962 -112)
(2) Med. Base LED 3000K,
9W, 800 Lumen lamps incl.
T24-2 EN*



E

Brushed Nickel Finish (-962)
Cased Opal Etched Glass



G

Chrome Finish (-05)
Cased Opal Etched Glass



Midnight Black Finish (-112)
Cased Opal Etched Glass

FINISH CODES

- (-05) Chrome
- (-962) Brushed Nickel
- (-112) Midnight Black

H. FOUR LIGHT WALL / BATH

W: 27.5" H: 8.5" E: 5.5"
 Height from center of outlet box
 up: 6.25" down: 2.25"

DAMP +

41163(-05 -962 -112)

(4) Medium Base 75W max.

T24-1

41163EN3(-05 -962 -112)

(4) Med. Base LED 3000K,
 9W, 800 Lumen lamps incl.

T24-2 EN*



H

Chrome Finish (-05)
 Cased Opal Etched Glass

I. THREE LIGHT WALL / BATH

W: 20" H: 8.5" E: 5.5"
 Height from center of outlet box
 up: 6.25" down: 2.25"

DAMP +

41162(-05 -962 -112)

(3) Medium Base 75W max.

T24-1

41162EN3(-05 -962 -112)

(3) Med. Base LED 3000K,
 9W, 800 Lumen lamps incl.

T24-2 EN*



I

Brushed Nickel Finish (-962)
 Cased Opal Etched Glass

J. TWO LIGHT WALL / BATH

W: 12.5" H: 8.5" E: 5.5"
 Height from center of outlet box
 up: 6.25" down: 2.25"

DAMP +

41161(-05 -962 -112)

(2) Medium Base 75W max.

T24-1

41161EN3(-05 -962 -112)

(2) Med. Base LED 3000K,
 9W, 800 Lumen lamps incl.

T24-2 EN*



J

Bronze Finish (-710)
 Cased Opal Etched Glass

K. ONE LIGHT WALL / BATH SCONCE

W: 4.75" H: 8.75" E: 5.5"
 Height from center of outlet box
 up: 4.75" down: 4"

DAMP +

41160(-05 -962 -112)

(1) Medium Base 75W max.

T24-1

41160EN3(-05 -962 -112)

(1) Med. Base LED 3000K,
 9W, 800 Lumen lamp incl.

T24-2 EN*



K

Midnight Black Finish (-112)
 Cased Opal Etched Glass

FINISH CODES

- (-05) Chrome
- (-962) Brushed Nickel
- (-112) Midnight Black

A. LARGE NINE LIGHT CHANDELIER

D: 26" H: 26.75"
12' Wire pre-laced through 10' of chain

31172(-112 -710 -962)
(9) Medium Base 60W max.
T24-1 +

31172EN7(-112 -710 -962)
(9) Med. Base LED 3000K,
9W, 800 Lumen lamps incl.
T24-2 EN*

B. MEDIUM FIVE LIGHT CHANDELIER

D: 24" H: 20"
12' Wire pre-laced through 10' of chain

31171(-112 -710 -962)
(5) Medium Base 75W max.
T24-1

31171EN7(-112 -710 -962)
(5) Med. Base LED 2700K,
8W, 800 Lumen lamps incl.
T24-2 EN*

C. SMALL THREE LIGHT CHANDELIER

D: 15" H: 16.5"
12' Wire pre-laced through 10' of chain

31170(-112 -710 -962)
(3) Medium Base 75W max.
T24-1 +

31170EN7(-112 -710 -962)
(3) Med. Base LED 2700K,
8W, 800 Lumen lamps incl.
T24-2 EN*

D. ONE LIGHT MINI-PENDANT

D: 4" H: 5.75"
10' Wire, (3) 12" Stems, (1) 6" Stem
Sloped Ceiling Mounting
Hardware incl.

61170(-112 -710 -962)
(1) Medium Base 75W max.
T24-1

61170EN7(-112 -710 -962)
(1) Med. Base LED 2700K,
8W, 800 Lumen lamp incl.
T24-2 EN*



A

Midnight Black Finish (-112)
Clear Seeded Glass



C

Brushed Nickel Finish (-962)
Clear Seeded Glass



B

Bronze Finish (-710)
Clear Seeded Glass



D

Midnight Black Finish (-112)
Clear Seeded Glass

FINISH CODES

- (-112) Midnight Black
- (-710) Bronze
- (-962) Brushed Nickel

E. FOUR LIGHT WALL / BATH

W: 27.5" H: 8.5" E: 5.5"
 Height from center of outlet box
 up: 6.25" down: 2.25"

DAMP +

41173(-05 -112 -710 -962)

(4) Medium Base 75W max.

T24-1

41173EN7(-05 -112 -710 -962)

(4) Med. Base LED 2700K,
 8W, 800 Lumen lamps incl.

T24-2 EN*



E

Bronze Finish (-710)
 Clear Seeded Glass

F. THREE LIGHT WALL / BATH

W: 20" H: 8.5" E: 5.5"
 Height from center of outlet box
 up: 6.25" down: 2.25"

DAMP +

41172(-05 -112 -710 -962)

(3) Medium Base 75W max.

T24-1

41172EN7(-05 -112 -710 -962)

(3) Med. Base LED 2700K,
 8W, 800 Lumen lamps incl.

T24-2 EN*



F

Brushed Nickel Finish (-962)
 Clear Seeded Glass

G. TWO LIGHT WALL / BATH

W: 12.5" H: 8.5" E: 5.5"
 Height from center of outlet box
 up: 6.25" down: 2.25"

DAMP +

41171(-05 -112 -710 -962)

(2) Medium Base 75W max.

T24-1 +

41171EN7(-05 -112 -710 -962)

(2) Med. Base LED 2700K,
 8W, 800 Lumen lamps incl.

T24-2 EN*



G

Chrome Finish (-05)
 Clear Seeded Glass

H. ONE LIGHT WALL / BATH SCONCE

W: 4.75" H: 8.75" E: 5.5"
 Height from center of outlet box
 up: 4.75" down: 4"

DAMP +

41170(-05 -112 -710 -962)

(1) Medium Base 75W max.

T24-1

41170EN7(-05 -112 -710 -962)

(1) Med. Base LED 2700K,
 8W, 800 Lumen lamp incl.

T24-2 EN*



H

Midnight Black Finish (-112)
 Clear Seeded Glass

FINISH CODES

- (-05) Chrome
- (-962) Brushed Nickel
- (-710) Bronze
- (-112) Midnight Black



PRODUCT SHOWN: SEVILLE NINE LIGHT CHANDELIER IN BRONZE FINISH

A. LARGE NINE LIGHT CHANDELIER

D: 28.875" H: 27.125"
10' of Wire pre-laced through 6' of Chain

DAMP

3120209(-962 -710)

(9) Medium Base 75W max.

T24-1

3120209EN3(-962 -710)

(9) Med. Base LED 3000K,
9W, 800 Lumen lamps incl.

T24-2 EN*

B. MEDIUM FIVE LIGHT CHANDELIER

D: 21" H: 17.5"
6' of Wire pre-laced through 3' of Chain

DAMP

3120205(-962 -710)

(5) Medium Base 75W max.

T24-1

3120205EN3(-962 -710)

(5) Med. Base LED 3000K,
9W, 800 Lumen lamps incl.

T24-2 EN*

C. SMALL THREE LIGHT CHANDELIER

D: 17" H: 15.75"
6' of Wire pre-laced through 3.5'
of Chain

DAMP

3120203(-962 -710)

(3) Medium Base 75W max.

T24-1

3120203EN3(-962 -710)

(3) Med. Base LED 3000K,
9W, 800 Lumen lamps incl.

T24-2 EN*



A

Brushed Nickel Finish (-962)
Etched White Glass



B

Bronze Finish (-710)
Etched White Glass



C

Brushed Nickel Finish (-962)
Etched White Glass

FINISH CODES

- (-962) Brushed Nickel
- (-710) Bronze

**D. MEDIUM FIVE LIGHT
HANGING SHADE**

D: 21.5" H: 22.125"
6' of Wire pre-laced through 3.5'
of Chain

DAMP

3320205(-962 -710)

(5) Candelabra Base 60W max.

T24-1

3320205EN(-962 -710)

(5) LED Cand. Base 2700K,
3.5W, 350 Lumen lamps incl.

T24-2 EN *

**E. MEDIUM THREE
LIGHT PENDANT**

D: 18.625" H: 20.625"
10' Wire pre-laced through 6'
Chain

DAMP

6616503(-962 -710)

(3) Medium Base 75W max.

T24-1

6616503EN3(-962 -710)

(3) Med. Base LED 3000K,
9W, 800 Lumen lamps incl.

T24-2 EN *



D

Bronze Finish (-710)
White Linen Shade



E

Brushed Nickel Finish (-962)
Satin Etched Glass

FINISH CODES

(-962) Brushed Nickel
(-710) Bronze

F. ONE LIGHT MINI-PENDANT

D: 4" H: 7"
 10' of Wire, (3) 12" Stems, (1) 6" Stem
 Sloped Ceiling Mounting Hardware incl.

DAMP

6120201(-962 -710)

(1) Medium Base 75W max.

T24-1

6120201EN3(-962 -710)

(1) Med. Base LED 3000K,
 9W, 800 Lumen lamps incl.

T24-2 EN*

**G. SMALL TWO LIGHT
 SEMI-FLUSH / PENDANT**

D: 13.875" H: 12.375" Semi-Flush 11.375"
 6' Wire pre-laced through 3' Chain

DAMP +

7716502(-962 -710)

(2) Medium Base 75W max.

T24-1

7716502EN3(-962 -710)

(2) Med. Base LED 3000K,
 9W, 800 Lumen lamps incl.

T24-2 EN*



F

Bronze Finish (-710)
 Etched White Glass

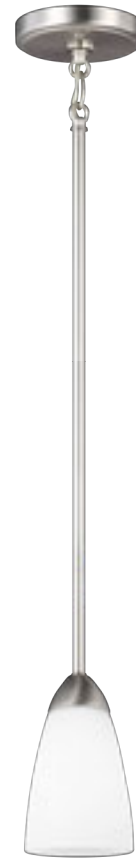

Brushed Nickel Finish (-962)
 Etched White Glass



G

Bronze Finish (-710)
 Satin Etched Glass

FINISH CODES

(-962) Brushed Nickel
 (-710) Bronze

H. FIVE LIGHT WALL / BATH

W: 35.875" H: 8.5" E: 6.625"
Height from center of outlet box
up: 3.375" down: 5.125"

DAMP +

4420205(-05 -962 -710)

(5) Medium Base 75W max.

T24-1

4420205EN3(-05 -962 -710)

(5) Med. Base LED 3000K,
9W, 800 Lumen lamp incl.

T24-2 EN*

I. FOUR LIGHT WALL / BATH

W: 28.375" H: 8.5" E: 6.625"
Height from center of outlet box
up: 3.375" down: 5.125"

DAMP +

4420204(-05 -962 -710)

(4) Medium Base 75W max.

T24-1

4420204EN3(-05 -962 -710)

(4) Med. Base LED 3000K,
9W, 800 Lumen lamp incl.

T24-2 EN*



H

Chrome Finish (-05)
Etched, White Inside Glass



I

Brushed Nickel Finish (-962)
Etched, White Inside Glass

FINISH CODES

(-05) Chrome
(-962) Brushed Nickel
(-710) Bronze

J. THREE LIGHT WALL / BATH

W: 21" H: 8.5" E: 6.625"
 Height from center of outlet box
 up: 3.375" down: 5.125"

DAMP +

4420203(-05 -962 -710)

(3) Medium Base 75W max.

T24-1

4420203EN3(-05 -962 -710)

(3) Med. Base LED 3000K,
 9W, 800 Lumen lamp incl.

T24-2 EN*



J

Bronze Finish (-710)
 Etched, White Inside Glass

K. TWO LIGHT WALL / BATH

W: 13.5" H: 8.5" E: 6.625"
 Height from center of outlet box
 up: 3.375" down: 5.125"

DAMP +

4420202(-05 -962 -710)

(2) Medium Base 75W max.

T24-1

4420202EN3(-05 -962 -710)

(2) Med. Base LED 3000K,
 9W, 800 Lumen lamp incl.

T24-2 EN*



K

Chrome Finish (-05)
 Etched, White Inside Glass

L. ONE LIGHT WALL / BATH SCONCE

W: 4.75" H: 8.5" E: 6.625"
 Height from center of outlet box
 up: 3.375" down: 5.125"

DAMP +

4120201(-05 -962 -710)

(1) Medium Base 75W max.

T24-1

4120201EN3(-05 -962 -710)

(1) Med. Base LED 3000K,
 9W, 800 Lumen lamp incl.

T24-2 EN*



L

Brushed Nickel Finish (-962)
 Etched, White Inside Glass

FINISH CODES

- (-05) Chrome
- (-962) Brushed Nickel
- (-710) Bronze



PRODUCT SHOWN: WINDOM NINE LIGHT
CHANDELIER IN SATIN BRASS FINISH

A. LARGE NINE LIGHT CHANDELIER

D: 28" H: 30"
10' of wire pre-laced through 6' of chain
DAMP

3102809(-962 -848 -710 -112)

(9) Medium Base 75W max.
T24-1

3102809EN3(-962 -848 -710 -112)

(9) Med. Base LED 3000K
9W, 800 Lumen lamps incl.
T24-2 EN*

B. MEDIUM FIVE LIGHT CHANDELIER

D: 20" H: 19.75"
6' of wire pre-laced through 3' of chain
DAMP

3102805(-962 -848 -710 -112)

(5) Medium Base 75W max.
T24-1

3102805EN3(-962 -848 -710 -112)

(5) Med. Base LED 3000K
9W, 800 Lumen lamps incl.
T24-2 EN*

C. SMALL THREE LIGHT CHANDELIER

D: 18" H: 16.5"
6' of wire pre-laced through 3' of chain
DAMP

3102803(-962 -848 -710 -112)

(3) Medium Base 75W max.
T24-1

3102803EN3(-962 -848 -710 -112)

(3) Med. Base LED 3000K
9W, 800 Lumen lamps incl.
T24-2 EN*



A
Brushed Nickel (-962)
Etched Opal Glass



B
Midnight Black Finish (-112)
Etched Opal Glass



C
Bronze (-710)
Etched Opal Glass

FINISH CODES

- (-962) Brushed Nickel
- (-848) Satin Brass
- (-710) Bronze
- (-112) Midnight Black

D. ONE LIGHT MINI-PENDANT

D: 4.25" H: 5.875"
 Supplied with 8' of Wire
 (3) 12" Stems, (1) 6" Stem
 Sloped Ceiling Mounting Hardware Incl.
 DAMP

6102801(-962 -848 -710 -112)

(1) Medium Base 75W max.
 T24-1

6102801EN3(-962 -848 -710 -112)

(1) Med. Base LED 3000K
 9W, 800 Lumen lamp incl.
 T24-2 EN*

E. MEDIUM THREE LIGHT PENDANT

D: 18.625" H: 20.625"
 10' Wire pre-laced through 6' Chain
 DAMP

6616503(-962 -848 -710 -112)

(3) Medium Base 75W max.
 T24-1

6616503EN3(-962 -848 -710 -112)

(3) Med. Base LED 3000K,
 9W, 800 Lumen lamps incl.
 T24-2 EN*

F. SMALL TWO LIGHT SEMI-FLUSH CONVERTIBLE PENDANT

D: 13.875" H: 12.375" Semi-Flush 11.375"
 6' Wire pre-laced through 3' Chain
 DAMP +

7716502(-962 -848 -710 -112)

(2) Medium Base 100W max.
 T24-1

7716502EN3(-962 -848 -710 -112)

(2) Med. Base LED 3000K,
 9W, 800 Lumen lamps incl.
 T24-2 EN*



E

Midnight Black Finish (-112)
 Satin Etched Glass



D

Satin Brass Finish (-848)
 Etched Opal Glass

Bronze (-710)
 Etched Opal Glass



F

Brushed Nickel Finish (-962)
 Satin Etched Glass

FINISH CODES

- (-962) Brushed Nickel
- (-848) Satin Brass
- (-710) Bronze
- (-112) Midnight Black

G. FOUR LIGHT WALL / BATH

W: 24.375" H: 7.5" E: 6.625"
 Height from center of outlet box
 up: 5.1875" down: 2.3125"

DAMP +

4402804(-05-962-848-710-112)

(4) Medium Base 75W max.

T24-1

4402804EN3(-05-962-848-710-112)

(4) Med. Base LED 3000K,
 9W, 800 Lumen lamps incl.

T24-2 EN*



G

Satin Brass Finish (-848)
 Etched Opal Glass

H. THREE LIGHT WALL / BATH

W: 18" H: 7.5" E: 6.625"
 Height from center of outlet box
 up: 5.1875" down: 2.3125"

DAMP +

4402803(-05-962-848-710-112)

(3) Medium Base 75W max.

T24-1

4402803EN3(-05-962-848-710-112)

(3) Med. Base LED 3000K,
 9W, 800 Lumen lamps incl.

T24-2 EN*



H

Brushed Nickel Finish (-962)
 Etched Opal Glass

I. TWO LIGHT WALL / BATH

W: 12" H: 7.5" E: 6.625"
 Height from center of outlet box
 up: 5.1875" down: 2.3125"

DAMP +

4402802(-05-962-848-710-112)

(2) Medium Base 75W max.

T24-1

4402802EN3(-05-962-848-710-112)

(2) Med. Base LED 3000K,
 9W, 800 Lumen lamps incl.

T24-2 EN*



I

Chrome Finish (-05)
 Etched Opal Glass

J. ONE LIGHT WALL / BATH SCONCE

W: 4.5" H: 11.375" E: 6.625"
 Height from center of outlet box
 up: 7.375" down: 4"

DAMP +

4102801(-05-962-848-710-112)

(1) Medium Base 75W max.

T24-1

4102801EN3(-05-962-848-710-112)

(1) Med. Base LED 3000K,
 9W, 800 Lumen lamp incl.

T24-2 EN*



J

Bronze Finish (-710)
 Etched Opal Glass

Midnight Black Finish (-112)
 Etched Opal Glass

FINISH CODES

- (-05) Chrome
- (-962) Brushed Nickel
- (-848) Satin Brass
- (-710) Bronze
- (-112) Midnight Black

**A. LARGE NINE
LIGHT CHANDELIER**

D: 29" H: 29.5"

10' Wire pre-laced through 6' Chain

DAMP

3115209(-05 -962 -710)

(9) Medium Base 75W max.

T24-1

3115209EN3(-05 -962 -710)

(9) Med. Base LED 3000K,

9W, 800 Lumen lamps incl.

T24-2 EN*



A

Chrome Finish (-05)
Satin Etched Glass



Bronze Finish (-710)
Satin Etched Glass

FINISH CODES

- (-05) Chrome
- (-962) Brushed Nickel
- (-710) Bronze

**B. MEDIUM FIVE
LIGHT CHANDELIER**

D: 20.375" H: 17" Downlight H: 24.75"
6" Wire pre-laced through 3' Chain

DAMP +

3115205(-05 -962 -710)

(5) Medium Base 75W max.
T24-1

3115205EN3(-05 -962 -710)

(5) Med. Base LED 3000K,
9W, 800 Lumen lamps incl.
T24-2 EN *

**C. SMALL THREE
LIGHT CHANDELIER**

D: 18" H: 15" Downlight H: 22"
6" Wire pre-laced through 3' Chain

DAMP +

3115203(-05 -962 -710)

(3) Medium Base 75W max.
T24-1

3115203EN3(-05 -962 -710)

(3) Med. Base LED 3000K,
9W, 800 Lumen lamps incl.
T24-2 EN *



B
Brushed Nickel Finish (-962)
Satin Etched Glass

C
Bronze Finish (-710)
Satin Etched Glass

Downlight Chrome Finish (-05)
Satin Etched Glass

FINISH CODES

- (-05) Chrome
- (-962) Brushed Nickel
- (-710) Bronze

D. EXTRA LARGE THREE LIGHT PENDANT

D: 19.25" H: 18.375"
6" Wire pre-laced through 3' Chain

DAMP

6615203(-05 -962 -710)

(3) Medium Base 75W max.

T24-1

6615203EN3(-05 -962 -710)

(3) Med. Base LED 3000K, 9W, 800 Lumen lamps incl.

T24-2 EN*



D

Chrome Finish (-05)
Satin Etched Glass

E. MEDIUM TWO LIGHT SEMI-FLUSH CONVERTIBLE PENDANT

D: 15" H: 10.5" Semi-Flush H: 9"
6" Wire pre-laced through 3' Chain

DAMP +

7715202(-05 -962 -710)

(2) Medium Base 75W max.

T24-1

7715202EN3(-05 -962 -710)

(2) Med. Base LED 3000K, 9W, 800 Lumen lamps incl.

T24-2 EN*



F

Bronze Finish (-710)
Satin Etched Glass

F. LARGE ONE LIGHT PENDANT

D: 15" H: 8"
6" Wire pre-laced through 3' Chain

DAMP

6515201(-05 -962 -710)

(1) Medium Base 75W max.

T24-1

6515201EN3(-05 -962 -710)

(1) Med. Base LED 3000K, 9W, 800 Lumen lamp incl.

T24-2 EN*



E

Brushed Nickel Finish (-962)
Satin Etched Glass

G. ONE LIGHT MINI-PENDANT

D: 4.375" H: 6.375"
6" Wire, (3) 12" Stems, 12" Chain
Sloped Ceiling Mounting Hardware incl.

DAMP

6115201(-05 -962 -710)

(1) Medium Base 75W max.

T24-1

6115201EN3(-05 -962 -710)

(1) Med. Base LED 3000K, 9W, 800 Lumen lamp incl.

T24-2 EN*



G

Chrome Finish (-05)
Satin Etched Glass



Bronze Finish (-710)
Satin Etched Glass

FINISH CODES

- (-05) Chrome
- (-962) Brushed Nickel
- (-710) Bronze

H. FOUR LIGHT WALL / BATH

W: 24.75" H: 9" E: 6.75"
 Height from center of outlet box
 up: 6.75" down: 2.25"

DAMP +

4415204(-05 -962 -710)

(4) Medium Base 75W max.

T24-1

4415204EN3(-05 -962 -710)

(4) Med. Base LED 3000K,
 9W, 800 Lumen lamp incl.

T24-2 EN*



H

Chrome Finish (-05)
 Satin Etched Glass

I. THREE LIGHT WALL / BATH

W: 18" H: 9" E: 6.75"
 Height from center of outlet box
 up: 6.75" down: 2.25"

DAMP +

4415203(-05 -962 -710)

(3) Medium Base 75W max.

T24-1

4415203EN3(-05 -962 -710)

(3) Med. Base LED 3000K,
 9W, 800 Lumen lamp incl.

T24-2 EN*



I

Brushed Nickel Finish (-962)
 Satin Etched Glass

J. TWO LIGHT WALL / BATH

W: 12" H: 9" E: 6.75"
 Height from center of outlet box
 up: 6.75" down: 2.25"

DAMP +

4415202(-05 -962 -710)

(2) Medium Base 75W max.

T24-1

4415202EN3(-05 -962 -710)

(2) Med. Base LED 3000K,
 9W, 800 Lumen lamp incl.

T24-2 EN*



J

Bronze Finish (-710)
 Satin Etched Glass

K. ONE LIGHT WALL / BATH SCONCE

W: 4.75" H: 9.75" E: 6.75"
 Height from center of outlet box
 up: 5.75" down: 4"

DAMP +

4115201(-05 -962 -710)

(1) Medium Base 75W max.

T24-1

4115201EN3(-05 -962 -710)

(1) Med. Base LED 3000K,
 9W, 800 Lumen lamp incl.

T24-2 EN*



K

Chrome Finish (-05)
 Satin Etched Glass

FINISH CODES

- (-05) Chrome
- (-962) Brushed Nickel
- (-710) Bronze

**A. MEDIUM FOUR LIGHT
LINEAR CHANDELIER**

L: 40.75" W: 5.5" H: 15"
6' Wire, (3) 12" Stems, (1) 6" Stem

6614504(-962 -710 -112)

(4) Medium Base 60W max.

T24-1

6614504EN7(-962 -710 -112)

(4) Med. Base LED 2700K,
8W, 800 Lumen lamps incl.

T24-2 EN*

**B. LARGE NINE LIGHT
UP CHANDELIER**

D: 32" H: 22"
10' Wire, (3) 12" Stems, (1) 6" Stem
Sloped Ceiling Mounting Hardware incl.

3214509(-962 -710 -112)

(9) Medium Base 60W max.

T24-1

3214509EN7(-962 -710 -112)

(9) Med. Base LED 2700K,
8W, 800 Lumen lamps incl.

T24-2 EN*



B

Brushed Nickel Finish (-962)
Clear Seeded Glass



A

Bronze Finish (-710)
Clear Seeded Glass

FINISH CODES

(-962) Brushed Nickel

(-710) Bronze

(-112) Midnight Black

C. MEDIUM FIVE LIGHT CHANDELIER

D: 24" H: 10.5"
6' Wire, (3) 12" Stems, (1) 6" Stem
Sloped Ceiling Mounting Hardware incl.

3114505(-962 -710 -112)

(5) Medium Base 60W max.
T24-1

3114505EN7(-962 -710 -112)

(5) Med. Base LED 2700K,
8W, 800 Lumen lamps incl.
T24-2 EN*

D. MEDIUM FIVE LIGHT UP CHANDELIER

D: 23.875" H: 10.5"
6' Wire, (3) 12" Stems, (1) 6" Stem
Sloped Ceiling Mounting Hardware incl.

3214505(-962 -710 -112)

(5) Medium Base 60W max.
T24-1

3214505EN7(-962 -710 -112)

(5) Med. Base LED 2700K,
8W, 800 Lumen lamps incl.
T24-2 EN*

E. SMALL THREE LIGHT CHANDELIER

D: 19.875" H: 10.5"
6' Wire, (3) 12" Stems, (1) 6" Stem
Sloped Ceiling Mounting Hardware incl.

3114503(-962 -710 -112)

(3) Medium Base 60W max.
T24-1

3114503EN7(-962 -710 -112)

(3) Med. Base LED 2700K,
8W, 800 Lumen lamps incl.
T24-2 EN*



C

Bronze Finish (-710)
Clear Seeded Glass

E

Midnight Black Finish (-112)
Clear Seeded Glass



D

Bronze Finish (-710)
Clear Seeded Glass

FINISH CODES

- (-962) Brushed Nickel
- (-710) Bronze
- (-112) Midnight Black

F. LARGE ONE LIGHT PENDANT

D: 16" H: 12.75"
 6' Wire, (3) 12" Stems, (1) 6" Stem, Sloped Ceiling Mounting Hardware incl. For Additional Lamping Options, Please See GenerationLighting.com

6614501-962

(1) Medium Base 75W max.

T24-1

G. MEDIUM ONE LIGHT PENDANT

D: 12.75" H: 11.5"
 6' Wire, (3) 12" Stems, (1) 6" Stem Sloped Ceiling Mounting Hardware incl.

6514501-962

(1) Medium Base 75W max.

T24-1

6514501EN7-962

(1) Med. Base LED 2700K, 8W, 800 Lumen lamp incl.

T24-2 EN *

H. MEDIUM ONE LIGHT PENDANT

D: 12" H: 10.125"
 10' Wire, (3) 12" Stems, (1) 6" Stem Sloped Ceiling Mounting Hardware incl.

DAMP

6227801-112

(1) Medium Base 75W max.

T24-1

6227801EN7-112

(1) Med. Base LED 2700K, 8W, 800 Lumen lamp incl.

T24-2 EN *

I. ONE LIGHT MINI-PENDANT

D: 5.5" H: 9"
 6' Wire, (3) 12" Stems, (1) 6" Stem Sloped Ceiling Mounting Hardware incl.

6114501(-962 -710 -112)

(1) Medium Base 60W max.

T24-1

6114501EN7(-962 -710 -112)

(1) Med. Base LED 2700K, 8W, 800 Lumen lamp incl.

T24-2 EN *

J. SMALL THREE LIGHT CEILING FLUSH MOUNT

D: 11.25" H: 7.5"

DAMP

7514503(-962 -710)

(3) Candelabra 40W max.

T24-1

7514503EN(-962 -710)

(3) Cand. Base LED 2700K, 3.5W, 350 Lumen lamp incl.

T24-2 EN *

K. MEDIUM TWO LIGHT SEMI-FLUSH

D: 15" H: 10.375"

DAMP

7714502(-962 -710 -112)

(2) Medium Base 75W max.

T24-1

7714502EN7(-962 -710 -112)

(2) Med. Base LED 2700K, 8W, 800 Lumen lamps incl.

T24-2 EN *

FINISH CODES

- (-962) Brushed Nickel
- (-710) Bronze
- (-112) Midnight Black
- (-05) Chrome



F

Brushed Nickel Finish (-962)
 Clear Seeded Glass



G

Brushed Nickel Finish (-962)
 Clear Seeded Glass



H

Midnight Black Finish (-112)
 Clear Seeded Glass



I

Brushed Nickel Finish (-962)
 Clear Seeded Glass



J

Bronze Finish (-710)
 Clear Seeded Glass



K

Brushed Nickel Finish (-962)
 Clear Seeded Glass

L. FOUR LIGHT WALL / BATH

W: 28.75" H: 10.75" E: 6.75"
 Height from center of outlet box
 up: 8.5" down: 2.25"

DAMP +

4414504(-05 -962 -710 -112)

(4) Medium Base 60W max.

T24-1

4414504EN7(-05 -962 -710 -112)

(4) Med. Base LED 2700K,
 8W, 800 Lumen lamps incl.

T24-2 EN*



L

Chrome Finish (-05)
 Clear Seeded Glass

M. THREE LIGHT WALL / BATH

W: 21" H: 10.75" E: 6.75"
 Height from center of outlet box
 up: 8.5" down: 2.25"

DAMP +

4414503(-05 -962 -710 -112)

(3) Medium Base 60W max.

T24-1

4414503EN7(-05 -962 -710 -112)

(3) Med. Base LED 2700K,
 8W, 800 Lumen lamps incl.

T24-2 EN*



M

Brushed Nickel Finish (-962)
 Clear Seeded Glass

N. TWO LIGHT WALL / BATH

W: 15" H: 10.75" E: 6.75"
 Height from center of outlet box
 up: 8.5" down: 2.25"

DAMP +

4414502(-05 -962 -710 -112)

(2) Medium Base 60W max.

T24-1

4414502EN7(-05 -962 -710 -112)

(2) Med. Base LED 2700K,
 8W, 800 Lumen lamps incl.

T24-2 EN*



N

Bronze Finish (-710)
 Clear Seeded Glass

O. ONE LIGHT WALL / BATH SCONCE

W: 5.5" H: 9.75" E: 6.75"
 Height from center of outlet box
 up: 5.5" down: 4.25"

DAMP +

4414501(-05 -962 -710 -112)

(1) Medium Base 60W max.

T24-1

4414501EN7(-05 -962 -710 -112)

(1) Med. Base LED 2700K,
 8W, 800 Lumen lamp incl.

T24-2 EN*



O

Midnight Black Finish (-112)
 Clear Seeded Glass

FINISH CODES

- (-05) Chrome
- (-962) Brushed Nickel
- (-710) Bronze
- (-112) Midnight Black

**A. LARGE NINE
LIGHT CHANDELIER**

D: 31.375" H: 26"
6' of Wire, (3) 12" Stems,
(1) 6" Stem
Sloped Ceiling Mounting
Hardware incl.

DAMP

3128809(-962 -710 -112)

(9) Medium Base 75W max.

T24-1

3128809EN3(-962 -710 -112)

(9) Med. Base LED 3000K,
9W, 800 Lumen lamps incl.

T24-2

EN *

**A**

Brushed Nickel Finish (-962)
Etched White Glass



Midnight Black Finish (-112)
Etched White Glass

FINISH CODES

(-962) Brushed Nickel
(-710) Bronze
(-112) Midnight Black

B. MEDIUM FIVE LIGHT CHANDELIER

D: 23.875" H: 14.5"
 6' of Wire, (3) 12" Stems, (1) 6" Stem
 Sloped Ceiling Mounting Hardware incl.

DAMP

3128805(-962 -710 -112)

(5) Medium Base 75W max.

T24-1

3128805EN3(-962 -710 -112)

(5) Med. Base LED 3000K,
 9W, 800 Lumen lamps incl.

T24-2 EN*

C. SMALL THREE LIGHT CHANDELIER

D: 19.625" H: 13.125"
 6' of Wire, (3) 12" Stems, (1) 6" Stem
 Sloped Ceiling Mounting Hardware incl.

DAMP

3128803(-962 -710 -112)

(3) Medium Base 75W max.

T24-1

3128803EN3(-962 -710 -112)

(3) Med. Base LED 3000K,
 9W, 800 Lumen lamps incl.

T24-2 EN*



B

Brushed Nickel Finish (-962)
 Etched White Glass



Midnight Black Finish (-112)
 Etched White Glass



C

Bronze Finish (-710)
 Etched White Glass



Brushed Nickel Finish (-962)
 Etched White Glass

FINISH CODES

(-962) Brushed Nickel
 (-710) Bronze
 (-112) Midnight Black

D. LARGE THREE LIGHT PENDANT

D: 16" H: 18.5"
 10' Wire pre-laced through 6' Chain
 DAMP

6528803(-962 -710 -112)

(3) Medium Base 75W max.
 T24-1

6528803EN3(-962 -710 -112)

(3) Med. Base LED 3000K,
 9W, 800 Lumen lamps incl.
 T24-2 EN *



D

Brushed Nickel Finish (-962)
 Etched White Glass

E. LARGE THREE LIGHT SEMI-FLUSH MOUNT

D: 16" H: 12.5"
 DAMP

7728803(-962 -710 -112)

(3) Medium Base 75W max.
 T24-1

7728803EN3(-962 -710 -112)

(3) Med. Base LED 3000K,
 9W, 800 Lumen lamps incl.
 T24-2 EN *



E

Bronze Finish (-710)
 Etched White Glass

F. ONE LIGHT MINI-PENDANT

D: 5.5" H: 6.375"
 Supplied with 10' of Wire,
 (3) 12" Stems, (1) 6" Stem
 Sloped Ceiling Mounting Hardware incl.
 DAMP

6128801(-962 -710 -112)

(1) Medium Base 75W max.
 T24-1

6128801EN3(-962 -710 -112)

(1) Med. Base LED 3000K,
 9W Bulb Lamps incl.
 T24-2 EN *



F

Midnight Black Finish (-112)
 Etched White Glass



Brushed Nickel Finish (-962)
 Etched White Glass

FINISH CODES

- (-962) Brushed Nickel
- (-710) Bronze
- (-112) Midnight Black

G. FOUR LIGHT WALL / BATH

W: 31.875" H: 8.375" E: 7.25"
 Height from center of outlet box
 up: 5.75" down: 2.5"

DAMP +

4428804(-05 -962 -710 -112)

(4) Medium Base 75W max.

T24-1

4428804EN3(-05 -962 -710 -112)

(4) Med. Base LED 3000K,
 9W, 800 Lumen lamp incl.

T24-2 EN*



G

Midnight Black Finish (-112)
 Etched White Glass

H. THREE LIGHT WALL / BATH

W: 23.125" H: 8.375" E: 7.25"
 Height from center of outlet box
 up: 5.75" down: 2.5"

DAMP +

4428803(-05 -962 -710 -112)

(3) Medium Base 75W max.

T24-1

4428803EN3(-05 -962 -710 -112)

(3) Med. Base LED 3000K,
 9W, 800 Lumen lamp incl.

T24-2 EN*



H

Brushed Nickel Finish (-962)
 Etched, White Inside Glass

I. TWO LIGHT WALL / BATH

W: 14.25" H: 8.375" E: 7.25"
 Height from center of outlet box
 up: 5.75" down: 2.5"

DAMP +

4428802(-05 -962 -710 -112)

(2) Medium Base 75W max.

T24-1

4428802EN3(-05 -962 -710 -112)

(2) Med. Base LED 3000K,
 9W, 800 Lumen lamp incl.

T24-2 EN*



I

Bronze Finish (-710)
 Etched, White Inside Glass

J. ONE LIGHT WALL / BATH SCONCE

W: 5.5" H: 8.25" E: 7.25"
 Height from center of outlet box
 up: 4.375" down: 3.875"

DAMP +

4128801(-05 -962 -710 -112)

(1) Medium Base 75W max.

T24-1

4128801EN3(-05 -962 -710 -112)

(1) Med. Base LED 3000K,
 9W, 800 Lumen lamp incl.

T24-2 EN*



J

Chrome Finish (-05)
 Etched, White Inside Glass

FINISH CODES

- (-05) Chrome
- (-962) Brushed Nickel
- (-710) Bronze
- (-112) Midnight Black

**A. LARGE NINE
LIGHT CHANDELIER**

D: 30" H: 29"
10' of Wire pre-laced through 6'
of Chain

DAMP

3130709(-962 -112)

(9) Medium Base 75W max.

T24-1

3130709EN3(-962 -112)

(9) Med. Base LED 3000K,
9W, 800 Lumen lamps incl.

T24-2 EN*



A

Brushed Nickel Finish (-962)
Etched White Glass



Midnight Black Finish (-112)
Etched White Glass

FINISH CODES

(-962) Brushed Nickel
(-112) Midnight Black

B. MEDIUM FIVE LIGHT CHANDELIER

D: 24" H: 24"
6' of Wire pre-laced through
3' of Chain

DAMP

3130705(-962 -112)

(5) Medium Base 75W max.

T24-1

3130705EN3(-962 -112)

(5) Med. Base LED 3000K,
9W, 800 Lumen lamps incl.

T24-2 EN*

C. SMALL THREE LIGHT CHANDELIER

D: 18.625" H: 19"
6' of Wire pre-laced through
3' of Chain

DAMP

3130703(-962 -112)

(3) Medium Base 75W max.

T24-1

3130703EN3(-962 -112)

(3) Med. Base LED 3000K,
9W, 800 Lumen lamps incl.

T24-2 EN*



B

Brushed Nickel Finish (-962)
Etched White Glass



C

Midnight Black Finish (-112)
Etched White Glass

FINISH CODES

(-962) Brushed Nickel
(-112) Midnight Black

D. LARGE THREE LIGHT PENDANT

D: 16" H: 18.5"
10' Wire pre-laced through 6' Chain

DAMP

6528803(-962 -710 -112)

(3) Medium Base 75W max.

T24-1

6528803EN3(-962 -710 -112)

(3) Med. Base LED 3000K,
9W, 800 Lumen lamps incl.

T24-2 EN*



D

Brushed Nickel Finish (-962)
Etched White Glass



F

Bronze Finish (-710)
Etched White Glass

Midnight Black Finish (-112)
Etched White Glass

Brushed Nickel Finish (-962)
Etched White Glass

E. LARGE THREE LIGHT SEMI-FLUSH MOUNT

D: 16" H: 12.5"

DAMP

7728803(-962 -710 -112)

(3) Medium Base 75W max.

T24-1

7728803EN3(-962 -710 -112)

(3) Med. Base LED 3000K,
9W, 800 Lumen lamps incl.

T24-2 EN*



E

Bronze Finish (-710)
Etched White Glass

F. ONE LIGHT MINI-PENDANT

D: 4" H: 6.5"
Supplied with 10' of Wire,
(3) 12" Stems, (1) 6" Stem
Sloped Ceiling Mounting
Hardware incl.

DAMP

6130701(-962 -710 -112)

(1) Medium Base 75W max.

T24-1

6130701EN3(-962 -710 -112)

(1) Med. Base LED 3000K,
9W, 800 Lumen lamps incl.

T24-2 EN*

FINISH CODES

- (-962) Brushed Nickel
- (-710) Bronze
- (-112) Midnight Black

G. FOUR LIGHT WALL / BATH

W: 34" H: 7.125" E: 7.375"
 Height from center of outlet box
 up: 2.5625" down: 4.5265"

DAMP +

4430704(-962 -710 -112)

(4) Medium Base 75W max.

T24-1

4430704EN3(-962 -710 -112)

(4) Med. Base LED 3000K,
 9W, 800 Lumen lamps incl.

T24-2 EN*



G

Brushed Nickel Finish (-962)
 Etched, White Inside Glass

H. THREE LIGHT WALL / BATH

W: 24" H: 7.125" E: 7.375"
 Height from center of outlet box
 up: 2.5625" down: 4.5265"

DAMP +

4430703(-962 -710 -112)

(3) Medium Base 75W max.

T24-1

4430703EN3(-962 -710 -112)

(3) Med. Base LED 3000K,
 9W, 800 Lumen lamps incl.

T24-2 EN*



H

Bronze Finish (-710)
 Etched, White Inside Glass

I. TWO LIGHT WALL / BATH

W: 13.75" H: 7.125" E: 7.375"
 Height from center of outlet box
 up: 2.5625" down: 4.5265"

DAMP +

4430702(-962 -710 -112)

(2) Medium Base 75W max.

T24-1

4430702EN3(-962 -710 -112)

(2) Med. Base LED 3000K,
 9W, 800 Lumen lamps incl.

T24-2 EN*



I

Midnight Black Finish (-112)
 Etched, White Inside Glass

J. ONE LIGHT WALL / BATH SCONCE

W: 5" H: 15" E: 6.25"
 Height from center of outlet box
 up: 6" down: 8"

DAMP +

4130701(-962 -710 -112)

(1) Medium Base 75W max.

T24-1

4130701EN3(-962 -710 -112)

(1) Med. Base LED 3000K,
 9W, 800 Lumen lamp incl.

T24-2 EN*



J

Brushed Nickel Finish (-962)
 Etched, White Inside Glass

FINISH CODES

- (-962) Brushed Nickel
- (-710) Bronze
- (-112) Midnight Black



PRODUCT SHOWN: HETTINGER MEDIUM SIX LIGHT CHANDELIER IN BRUSHED NICKEL FINISH

A. LARGE NINE LIGHT CHANDELIER

D: 30" H: 24.625"
10' Wire pre-laced through 6' Chain

DAMP

3139109-962

(9) Medium Base 60W max.

T24-1

3139109EN3-962

(9) Med. Base LED 3000K,
9W, 800 Lumen lamps incl.

T24-2 EN*

B. MEDIUM SIX LIGHT CHANDELIER

D: 24.5" H: 18.25"
10' Wire pre-laced through 6' Chain

DAMP

3139106-962

(6) Medium Base 75W max.

T24-1

3139106EN3-962

(6) Med. Base LED 3000K,
9W, 800 Lumen lamps incl.

T24-2 EN*



A

Brushed Nickel Finish (-962)
Etched White Glass



B

Brushed Nickel Finish (-962)
Etched White Glass

FINISH CODE

(-962) Brushed Nickel

**C. EXTRA LARGE
THREE LIGHT PENDANT**

D: 19" H: 22.25"
10' Wire pre-laced through 6' Chain
DAMP

6639103-962
(3) Medium Base 75W max.
T24-1

6639103EN3-962
(3) Med. Base LED 3000K,
9W, 800 Lumen lamps incl.
T24-2 EN *

**D. MEDIUM TWO LIGHT SEMI-
FLUSH CONVERTIBLE PENDANT**

D: 13.25" H: 11.25" Semi-Flush H: 10.5"
10' Wire pre-laced through 3' Chain
DAMP +

7739102-962
(2) Medium Base 75W max.
T24-1

7739102EN3-962
(2) Med. Base LED 3000K,
9W, 800 Lumen lamps incl.
T24-2 EN *

**E. ONE LIGHT
MINI-PENDANT**

D: 3.5" H: 7.1875"
12' Wire, (3) 12" Stems, (1) 6" Stem
Sloped Ceiling Mounting Hardware incl.
DAMP

6124601-962
(1) Medium Base 75W max.
T24-1

6124601EN3-962
(1) Med. Base LED 3000K,
9W, 800 Lumen lamp incl.
T24-2 EN *



C

Brushed Nickel Finish (-962)
Etched White Glass



E

Brushed Nickel Finish (-962)
Etched White Glass



D

Bronze Finish (-710)
Etched White Glass

FINISH CODE

(-962) Brushed Nickel

F. FOUR LIGHT WALL / BATH

W: 29" H: 8" E: 6.25"
 Height from center of outlet box
 up: 5.75" down: 2.25"

DAMP +

4439104(-05 -962 -710 -112 -848)

(4) Medium Base 75W max.

T24-1

4439104EN3(-05 -962 -710 -112 -848)

(4) Med. Base LED 3000K,
 9W, 800 Lumen lamp incl.

T24-2 EN*



F

Satin Brass Finish (-848)
 Etched, White Inside Glass

G. THREE LIGHT WALL / BATH

W: 20.5" H: 8" E: 6.25"
 Height from center of outlet box
 up: 5.75" down: 2.25"

DAMP +

4439103(-05 -962 -710 -112 -848)

(3) Medium Base 75W max.

T24-1

4439103EN3(-05 -962 -710 -112 -848)

(3) Med. Base LED 3000K,
 9W, 800 Lumen lamp incl.

T24-2 EN*



G

Brushed Nickel Finish (-962)
 Etched, White Inside Glass

H. TWO LIGHT WALL / BATH

W: 13.5" H: 8" E: 5.75"
 Height from center of outlet box
 up: 5.75" down: 2.25"

DAMP +

4439102(-05 -962 -710 -112 -848)

(2) Medium Base 75W max.

T24-1

4439102EN3(-05 -962 -710 -112 -848)

(2) Med. Base LED 3000K,
 9W, 800 Lumen lamp incl.

T24-2 EN*



H

Midnight Black Finish (-112)
 Etched, White Inside Glass

Bronze Finish (-710)
 Etched, White Inside Glass

I. ONE LIGHT WALL / BATH SCONCE

W: 4.5" H: 8" E: 5"
 Height from center of outlet box
 up: 5.75" down: 2.25"

DAMP +

4139101(-05 -962 -710 -112 -848)

(1) Medium Base 75W max.

T24-1

4139101EN3(-05 -962 -710 -112 -848)

(1) Med. Base LED 3000K,
 9W, 800 Lumen lamp incl.

T24-2 EN*



I

Chrome Finish (-05)
 Etched, White Inside Glass

FINISH CODES

- (-05) Chrome
- (-962) Brushed Nickel
- (-710) Bronze
- (-112) Midnight Black
- (-848) Satin Brass

A. LARGE EIGHT LIGHT CHANDELIER

L: 35.5" W: 35.5" H: 27.75"
 Supplied with 10' of Wire,
 (3) 12" Stems, (1) 6" Stem
 Sloped Ceiling Mounting Hardware incl.

DAMP

3113708-962

(8) Medium Base 75W max.

T24-1

3113708EN3-962

(8) Med. Base LED 3000K,
 9W, 800 Lumen lamps incl.

T24-2 EN *

B. MEDIUM FOUR LIGHT CHANDELIER

L: 24.75" W: 24.75" H: 19.25"
 Supplied with 10' of Wire,
 (3) 12" Stems, (1) 6" Stem
 Sloped Ceiling Mounting Hardware incl.

DAMP

3113704-962

(4) Medium Base 75W max.

T24-1

3113704EN3-962

(4) Med. Base LED 3000K,
 9W, 800 Lumen lamps incl.

T24-2 EN *

C. ONE LIGHT MINI-PENDANT

L: 5.75" W: 5.75" H: 12"
 Supplied with 10' of Wire,
 (3) 12" Stems, (1) 6" Stem
 Sloped Ceiling Mounting Hardware incl.

DAMP

6113701(-962 -778)

(1) Medium Base 75W max.

T24-1

6113701EN3(-962 -778)

(1) Med. Base LED 3000K,
 9W 800 Lumen lamp incl.

T24-2 EN *

D. MEDIUM TWO LIGHT CEILING SEMI-FLUSH MOUNT

L: 13" W: 13" H: 7.5"

DAMP

7713702-962

(2) Medium Base 75W max.

T24-1

7713702EN3-962

(2) Med. Base LED 3000K,
 9W 800 Lumen lamp incl.

T24-2 EN *

E. MEDIUM TWO LIGHT CEILING FLUSH MOUNT

L: 13" W: 13" H: 5.375"

DAMP

7513702-962

(2) Medium Base 60W max.

T24-1

7513702EN3-962

(2) Med. Base LED 3000K,
 9W 800 Lumen lamp incl.

T24-2 EN *



A

Brushed Nickel Finish (-962)
 Etched White Glass



B

Brushed Nickel Finish (-962)
 Etched White Glass



C

Brushed Nickel Finish (-962)
 Etched White Glass



D

Brushed Nickel Finish (-962)
 Etched White Glass



E

Brushed Nickel Finish (-962)
 Etched White Glass

FINISH CODE

(-962) Brushed Nickel

F. FOUR LIGHT WALL / BATH

W: 32.5" H: 9.125" E: 6.625"
 Height from center of outlet box
 up: 6.625" down: 2.5"

DAMP +

4413704-962

(4) Medium Base 75W max.

T24-1

4413704EN3-962

(4) Med. Base LED 3000K,
 9W, 800 Lumen lamps incl.

T24-2 EN*



F

Brushed Nickel Finish (-962)
 Etched White Glass

G. THREE LIGHT WALL / BATH

W: 23.625" H: 9.125" E: 6.625"
 Height from center of outlet box
 up: 6.625" down: 2.5"

DAMP +

4413703-962

(3) Medium Base 75W max.

T24-1

4413703EN3-962

(3) Med. Base LED 3000K,
 9W, 800 Lumen lamps incl.

T24-2 EN*



B

Brushed Nickel Finish (-962)
 Etched White Glass

H. TWO LIGHT WALL / BATH

W: 16.125" H: 9.125" E: 6.625"
 Height from center of outlet box
 up: 6.625" down: 2.5"

DAMP +

4413702-962

(2) Medium Base 75W max.

T24-1

4413702EN3-962

(2) Med. Base LED 3000K,
 9W, 800 Lumen lamps incl.

T24-2 EN*



H

Brushed Nickel Finish (-962)
 Etched White Glass

I. ONE LIGHT WALL / BATH SCONCE

W: 5.75" H: 10.125" E: 6.625"
 Height from center of outlet box
 up: 7.625" down: 2.5"

DAMP +

4413701-962

(1) Medium Base 75W max.

T24-1

4413701EN3-962

(1) Med. Base LED 3000K,
 9W Bulb lamps incl.

T24-2 EN*



I

Brushed Nickel Finish (-962)
 Etched White Glass

FINISH CODE

(-962) Brushed Nickel



PRODUCT SHOWN: FRANPORT LARGE
NINE LIGHT CHANDELIER IN BRONZE FINISH

A. LARGE NINE LIGHT CHANDELIER

D: 30" H: 27.625"
 10' Wire pre-laced through 6' Chain
 DAMP

3128909(-962 -710)
 (9) Medium Base 75W max.
 T24-1

3128909EN3(-962 -710)
 (9) Med. Base LED 3000K,
 9W, 800 Lumen lamps incl.
 T24-2 EN*

B. MEDIUM FIVE LIGHT CHANDELIER

D: 26" H: 22.875"
 10' Wire pre-laced through 6' Chain
 DAMP

3128905(-962 -710)
 (5) Medium Base 75W max.
 T24-1

3128905EN3(-962 -710)
 (5) Med. Base LED 3000K,
 9W, 800 Lumen lamps incl.
 T24-2 EN*

C. SMALL THREE LIGHT CHANDELIER

D: 20" H: 21"
 10' Wire pre-laced through 6' Chain
 DAMP

3128903(-962 -710)
 (3) Medium Base 75W max.
 T24-1

3128903EN3(-962 -710)
 (3) Med. Base LED 3000K,
 9W, 800 Lumen lamps incl.
 T24-2 EN*



A

Bronze Finish (-710)
 Satin Etched Glass



B

Brushed Nickel Finish (-962)
 Satin Etched Glass



C

Bronze Finish (-710)
 Satin Etched Glass

FINISH CODES

(-962) Brushed Nickel
 (-710) Bronze

D. LARGE THREE LIGHT PENDANT

D: 20.75" H: 22.75"
6' Wire pre-laced through 3' Chain

DAMP

6624503-962

(3) Medium Base 75W max.

T24-1

6624503EN3-962

(3) Med. Base LED 3000K,
9W, 800 Lumen lamps incl.

T24-2 EN*

**E. LARGE THREE LIGHT SEMI-FLUSH
CONVERTIBLE PENDANT**

D: 20.75" H: 14.25" Semi-Flush H: 11.75"
6' Wire pre-laced through 3' Chain

DAMP +

7724503-962

(3) Medium Base 75W max.

T24-1

7724503EN3-962

(3) Med. Base LED 3000K,
9W, 800 Lumen lamps incl.

T24-2 EN*



D

Brushed Nickel Finish (-962)
Satin Etched Glass



E

Brushed Nickel Finish (-962)
Satin Etched Glass

FINISH CODE

(-962) Brushed Nickel

F. FOUR LIGHT WALL / BATH

W: 29.375" H: 8.25" E: 6.25"
 Height from center of outlet box
 up: 5.75" down: 2.5"

DAMP +

4428904(-05 -962 -710 -112)

(4) Medium Base 75W max.

T24-1

4428904EN3(-05 -962 -710 -112)

(4) Med. Base LED 3000K,
 9W, 800 Lumen lamp incl.

T24-2 EN*



F

Chrome Finish (-05)
 Etched, White Inside Glass

G. THREE LIGHT WALL / BATH

W: 21" H: 8.25" E: 6.25"
 Height from center of outlet box
 up: 5.75" down: 2.5"

DAMP +

4428903(-05 -962 -710 -112)

(3) Medium Base 75W max.

T24-1

4428903EN3(-05 -962 -710 -112)

(3) Med. Base LED 3000K,
 9W, 800 Lumen lamp incl.

T24-2 EN*



G

Bronze Finish (-710)
 Etched, White Inside Glass

H. TWO LIGHT WALL / BATH

W: 13.25" H: 8.25" E: 6.25"
 Height from center of outlet box
 up: 5.75" down: 2.5"

DAMP +

4428902(-05 -962 -710 -112)

(2) Medium Base 75W max.

T24-1

4428902EN3(-05 -962 -710 -112)

(2) Med. Base LED 3000K,
 9W, 800 Lumen lamp incl.

T24-2 EN*



H

Midnight Black Finish (-112)
 Etched, White Inside Glass

I. ONE LIGHT WALL / BATH SCONCE

W: 5" H: 8" E: 6.875"
 Height from center of outlet box
 up: 4" down: 4"

DAMP +

4128901(-05 -962 -710 -112)

(1) Medium Base 75W max.

T24-1

4128901EN3(-05 -962 -710 -112)

(1) Med. Base LED 3000K,
 9W, 800 Lumen lamp incl.

T24-2 EN*



I

Brushed Nickel Finish (-962)
 Etched, White Inside Glass

FINISH CODES

- (-05) Chrome
- (-962) Brushed Nickel
- (-710) Bronze
- (-112) Midnight Black



PRODUCT SHOWN: ROBIE NINE LIGHT
CHANDELIER IN MIDNIGHT BLACK FINISH

**A. EXTRA LARGE
TWELVE LIGHT CHANDELIER**

D: 40" H: 40.625"
10' of Wire pre-laced through 6' of Chain

DAMP

3121612(-962 -710 -112)

(12) Medium Base 75W max.

T24-1

3121612EN3(-962 -710 -112)

(12) Med. Base LED 3000K,
9W, 800 Lumen lamps incl.

T24-2 EN*

**B. LARGE NINE
LIGHT CHANDELIER**

D: 33" H: 34"
10' of Wire pre-laced through 6' of Chain

DAMP

3121609(-962 -710 -112)

(9) Medium Base 75W max.

T24-1

3121609EN3(-962 -710 -112)

(9) Med. Base LED 3000K,
9W, 800 Lumen lamps incl.

T24-2 EN*

**C. MEDIUM FIVE
LIGHT CHANDELIER**

D: 24.125" H: 23.375"
6' of Wire pre-laced through 3'
of Chain

DAMP

3121605(-962 -710 -112)

(5) Medium Base 75W max.

T24-1

3121605EN3(-962 -710 -112)

(5) Med. Base LED 3000K,
9W, 800 Lumen lamps incl.

T24-2 EN*

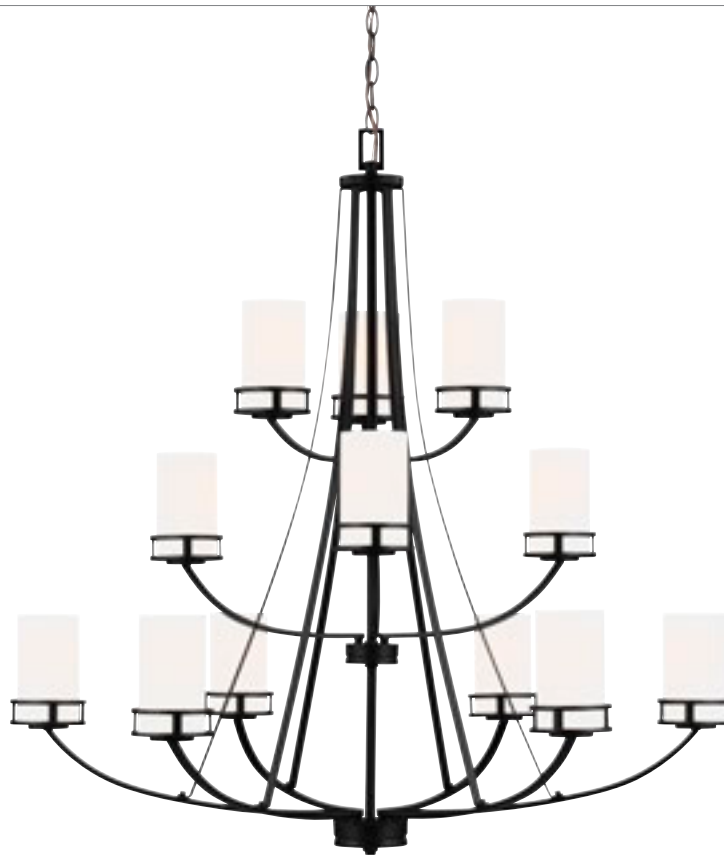

A

Midnight Black Finish (-112)
Etched White Glass

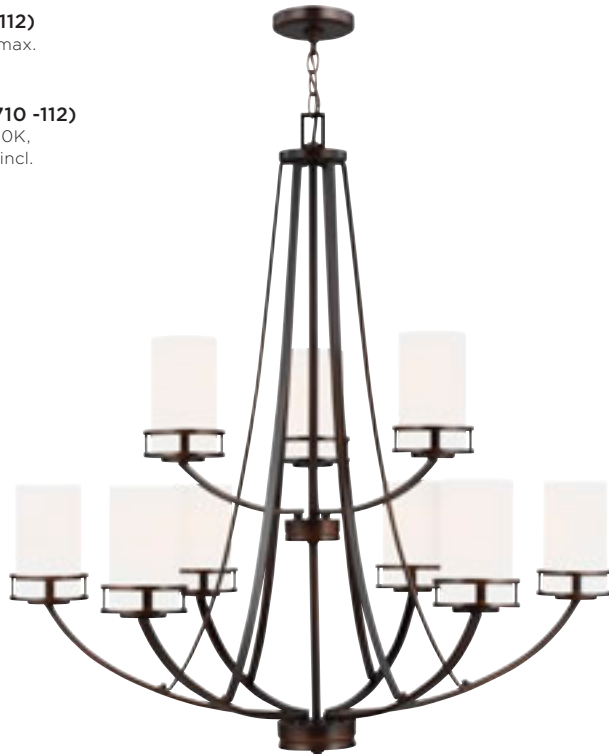

B

Bronze Finish (-710)
Etched White Glass



C

Brushed Nickel Finish (-962)
Etched White Glass

FINISH CODES

(-962) Brushed Nickel
(-710) Bronze
(-112) Midnight Black

D. SMALL THREE LIGHT CHANDELIER

D: 21.375" H: 22.125"
6' of Wire pre-laced through 3' of Chain
DAMP

3121603(-962 -710 -112)
(3) Medium Base 75W max.
T24-1

3121603EN3(-962 -710 -112)
(3) Med. Base LED 3000K,
9W, 800 Lumen lamps incl.
T24-2 EN *



D

Bronze Finish (-710)
Etched White Glass

E. ONE LIGHT MINI-PENDANT

D: 4.375" H: 6.5"
Supplied with 10' of Wire,
(3) 12" Stems, (1) 6" Stem
Sloped Ceiling Mounting Hardware incl.
DAMP

6121601(-962 -710 -112)
(1) Medium Base 75W max.
T24-1

6121601EN3(-962 -710 -112)
(1) Med. Base LED 3000K,
9W, 800 Lumen lamps incl.
T24-2 EN *



E

Midnight Black Finish (-112)
Etched White Glass

F. LARGE THREE LIGHT PENDANT

D: 16" H: 18.5"
10' Wire pre-laced through 6' Chain
DAMP

6528803(-962 -710 -112)
(3) Medium Base 75W max.
T24-1

6528803EN3(-962 -710 -112)
(3) Med. Base LED 3000K,
9W, 800 Lumen lamps incl.
T24-2 EN *



F

Brushed Nickel Finish (-962)
Etched White Glass

G. LARGE THREE LIGHT SEMI-FLUSH MOUNT

D: 16" H: 12.5"
DAMP

7728803(-962 -710 -112)
(3) Medium Base 75W max.
T24-1

7728803EN3(-962 -710 -112)
(3) Med. Base LED 3000K,
9W, 800 Lumen lamps incl.
T24-2 EN *



G

Bronze Finish (-710)
Etched White Glass

FINISH CODES

- (-962) Brushed Nickel
- (-710) Bronze
- (-112) Midnight Black

H. FOUR LIGHT WALL / BATH

W: 34" H: 8.125" E: 6.75"
 Height from center of outlet box
 up: 5.625" down: 2.5"

DAMP +

4421604(-05 -962 -710 -112)

(4) Medium Base 75W max.

T24-1

4421604EN3(-05 -962 -710 -112)

(4) Med. Base LED 3000K,
 9W, 800 Lumen lamps incl.

T24-2 EN*



H

Chrome Finish (-05)
 Etched, White Inside Glass

I. THREE LIGHT WALL / BATH

W: 24" H: 8.125" E: 6.75"
 Height from center of outlet box
 up: 5.625" down: 2.5"

DAMP +

4421603(-05 -962 -710 -112)

(3) Medium Base 75W max.

T24-1

4421603EN3(-05 -962 -710 -112)

(3) Med. Base LED 3000K,
 9W, 800 Lumen lamps incl.

T24-2 EN*



I

Brushed Nickel Finish (-962)
 Etched, White Inside Glass

J. TWO LIGHT WALL / BATH

W: 14.625" H: 8.125" E: 6.75"
 Height from center of outlet box
 up: 5.625" down: 2.5"

DAMP +

4421602(-05 -962 -710 -112)

(2) Medium Base 75W max.

T24-1

4421602EN3(-05 -962 -710 -112)

(2) Med. Base LED 3000K,
 9W, 800 Lumen lamps incl.

T24-2 EN*



J

Bronze Finish (-710)
 Etched, White Inside Glass

K. ONE LIGHT WALL / BATH SCONCE

W: 5" H: 8.125" E: 7.375"
 Height from center of outlet box
 up: 4.625" down: 3.5"

DAMP +

4121601(-05 -962 -710 -112)

(1) Medium Base 75W max.

T24-1

4121601EN3(-05 -962 -710 -112)

(1) Med. Base LED 3000K,
 9W, 800 Lumen lamp incl.

T24-2 EN*



K

Midnight Black Finish (-112)
 Etched, White Inside Glass

FINISH CODES

- (-05) Chrome
- (-962) Brushed Nickel
- (-710) Bronze
- (-112) Midnight Black



PRODUCT SHOWN: HANFORD LARGE NINE LIGHT CHANDELIER IN BRUSHED NICKEL FINISH

A. LARGE NINE LIGHT CHANDELIER

D: 33" H: 37"
 12' Wire pre-laced through 10' Chain
 DAMP

3124509-962
 (9) Medium Base 75W max.
 T24-1

3124509EN3-962
 (9) Med. Base LED 3000K,
 9W, 800 Lumen lamps incl.
 T24-2 EN*



A

Brushed Nickel Finish (-962)
 Satin Etched Glass



B

Brushed Nickel Finish (-962)
 Satin Etched Glass

B. MEDIUM FIVE LIGHT CHANDELIER

D: 27.75" H: 27.75"
 6' Wire pre-laced through 3' Chain
 DAMP

3124505-962
 (5) Medium Base 75W max.
 T24-1

3124505EN3-962
 (5) Med. Base LED 3000K,
 9W, 800 Lumen lamps incl.
 T24-2 EN*

C. SMALL THREE LIGHT CHANDELIER

D: 20" H: 22"
 6' of Wire pre-laced through 3' of Chain
 DAMP

3124503-962
 (3) Medium Base 75W max.
 T24-1

3124503EN3-962
 (3) Med. Base LED 3000K,
 9W, 800 Lumen lamps incl.
 T24-2 EN*

D. MEDIUM THREE LIGHT LANTERN

D: 18.25" H: 32.75"
 6' Wire pre-laced through 3' Chain
 DAMP

5224503-962
 (3) Medium Base 75W max.
 T24-1

5224503EN3-962
 (3) Med. Base LED 3000K,
 9W, 800 Lumen lamps incl.
 T24-2 EN*



C

Brushed Nickel Finish (-962)
 Satin Etched Glass



D

Brushed Nickel Finish (-962)
 Satin Etched Glass

FINISH CODE

(-962) Brushed Nickel

E. EXTRA LARGE THREE LIGHT PENDANT

D: 20.75" H: 22.75"
6' Wire pre-laced through
3' Chain

DAMP

6624503-962

(3) Medium Base 75W max.

T24-1

6624503EN3(-962)

(3) Med. Base LED 3000K,
9W, 800 Lumen lamps incl.

T24-2 EN*



E

Brushed Nickel Finish (-962)
Satin Etched Glass

F. ONE LIGHT MINI-PENDANT

D: 5.25" H: 6.75"
10' Wire, (3) 12" Stems,
(1) 6" Stem
Sloped Ceiling Mounting Hardware incl.

DAMP

6124501(-962 -710)

(1) Medium Base 75W max.

T24-1

6124501EN3(-962 -710)

(1) Med. Base LED 3000K,
9W, 800 Lumen lamp incl.

T24-2 EN*



F

Brushed Nickel Finish (-962)
Satin Etched Glass

G. LARGE THREE LIGHT SEMI-FLUSH CONVERTIBLE PENDANT

D: 20.75" H: 14.25" Semi-Flush H: 11.75"
6' Wire pre-laced through
3' Chain

DAMP +

7724503-962

(3) Medium Base 75W max.

T24-1

7724503EN3-962

(3) Med. Base LED 3000K,
9W, 800 Lumen lamps incl.

T24-2 EN*



G

Brushed Nickel Finish (-962)
Satin Etched Glass

FINISH CODES

(-962) Brushed Nickel
(-710) Bronze

H. FOUR LIGHT WALL / BATH

W: 33.5" H: 11.25" E: 6.5"
 Height from center of outlet box
 up: 6" down: 5.25"

DAMP +

4424504(-962 -710)

(4) Medium Base 75W max.

T24-1

4424504EN3(-962 -710)

(4) Med. Base LED 3000K,
 9W, 800 Lumen lamps incl.

T24-2 EN*



H

Brushed Nickel Finish (-962)
 Satin Etched Glass

I. THREE LIGHT WALL / BATH

W: 24" H: 10.75" E: 6.5"
 Height from center of outlet box
 up: 6" down: 4.75"

DAMP +

4424503(-962 -710)

(3) Medium Base 75W max.

T24-1

4424503EN3(-962 -710)

(3) Med. Base LED 3000K,
 9W, 800 Lumen lamps incl.

T24-2 EN*



I

Bronze Finish (-710)
 Satin Etched Glass

J. TWO LIGHT WALL / BATH

W: 14.5" H: 9.75" E: 6.5"
 Height from center of outlet box
 up: 6" down: 3.75"

DAMP +

4424502(-962 -710)

(2) Medium Base 75W max.

T24-1

4424502EN3(-962 -710)

(2) Med. Base LED 3000K,
 9W, 800 Lumen lamps incl.

T24-2 EN*



J

Brushed Nickel Finish (-962)
 Satin Etched Glass

K. ONE LIGHT WALL / BATH SCONCE

W: 5.25" H: 10.25" E: 6.75"
 Height from center of outlet box
 up: 7.25" down: 3"

DAMP +

4124501(-962 -710)

(1) Medium Base 75W max.

T24-1

4124501EN3(-962 -710)

(1) Med. Base LED 3000K,
 9W, 800 Lumen lamp incl.

T24-2 EN*



K

Bronze Finish (-710)
 Satin Etched Glass

FINISH CODES

(-962) Brushed Nickel
 (-710) Bronze



PRODUCT SHOWN: ELMWOOD PARK MEDIUM FOUR LIGHT
LINEAR CHANDELIER IN BRUSHED NICKEL FINISH

A. LARGE NINE LIGHT CHANDELIER

D: 32" H: 27.625"
12' of Wire pre-laced through 6' of Chain

DAMP

3137309(-962 -710)

(9) Medium Base 75W max.

T24-1

3137309EN3(-962 -710)

(9) Med. Base LED 3000K, 9W, 800 Lumen lamps incl.

T24-2 EN*

B. MEDIUM FIVE LIGHT CHANDELIER

D: 26" H: 24.125"
12' of Wire pre-laced through 6' of Chain

DAMP

3137305(-962 -710)

(5) Medium Base 75W max.

T24-1

3137305EN3(-962 -710)

(5) Med. Base LED 3000K, 9W, 800 Lumen lamps incl.

T24-2 EN*

C. MEDIUM FOUR LIGHT LINEAR CHANDELIER

L: 40" W: 4.375" H: 24.75"
Supplied with 6' of Wire, (3) 12" Stems, (1) 6" Stem

DAMP

6637304(-962 -710)

(4) Medium Base 75W max.

T24-1

6637304EN3(-962 -710)

(4) Med. Base LED 3000K, 9W, 800 Lumen lamps incl.

T24-2 EN*

D. SMALL THREE LIGHT CHANDELIER

D: 20.5" H: 21"
6' of Wire pre-laced through 3' of Chain

DAMP

3137303(-962 -710)

(3) Medium Base 75W max.

T24-1

3137303EN3(-962 -710)

(3) Med. Base LED 3000K, 9W, 800 Lumen lamps incl.

T24-2 EN*



A

Brushed Nickel Finish (-962)
Satin Etched Inner Glass, Clear Outer Glass



B

Bronze Finish (-710)
Satin Etched Inner Glass, Clear Outer Glass



D

Bronze Finish (-710)
Satin Etched Inner Glass, Clear Outer Glass



C

Brushed Nickel Finish (-962)
Satin Etched Inner Glass, Clear Outer Glass

FINISH CODES

(-962) Brushed Nickel
(-710) Bronze

E. MEDIUM THREE LIGHT HANGING SHADE

D: 19" H: 18"
 Supplied with 6' of Wire,
 (3) 12" Stems, (1) 6" Stem,
 Sloped Ceiling Mounting Hardware incl.

DAMP

6537303(-962 -710)

(3) Medium Base 75W max

T24-1

6537303EN3(-962 -710)

(3) Med. Base LED 3000K,
 9W, 800 Lumen lamps incl.

T24-2 EN *

F. LARGE THREE LIGHT SEMI FLUSH MOUNT

D: 19" H: 15.75"

DAMP

7737303(-962 -710)

(3) Medium Base 75W max.

T24-1

7737303EN3(-962 -710)

(3) Med. Base LED 3000K,
 9W, 800 Lumen lamps incl.

T24-2 EN *

G. ONE LIGHT MINI-PENDANT

D: 4.375" H: 6.875"
 Supplied with 6' of Wire,
 (3) 12" Stems, (1) 6" Stem,
 Sloped Ceiling Mounting Hardware incl.

DAMP

6137301(-962 -710)

(1) Medium Base 75W max.

T24-1

6137301EN3(-962 -710)

(1) Med. Base LED
 9W Bulb lamps incl.

T24-2 EN *

H. MEDIUM TWO LIGHT SEMI-FLUSH MOUNT

D: 15" H: 11"

DAMP

7737302(-962 -710)

(2) Medium Base 75W max.

T24-1

7737302EN3(-962 -710)

(2) Med. Base LED 3000K,
 9W, 800 Lumen lamps incl.

T24-2 EN *

I. MEDIUM TWO LIGHT CEILING FLUSH MOUNT

D: 14" H: 6.125"

DAMP

7537302(-962 -710)

(2) Medium Base 60W max.

T24-1

7537302EN3(-962 -710)

(2) Med. Base LED 3000K,
 9W, 800 Lumen lamps incl.

T24-2 EN *

FINISH CODES

(-962) Brushed Nickel
 (-710) Bronze



E

Brushed Nickel Finish (-962)
 Satin Etched Inner Glass,
 Off White Organza Silk Outer Shade



G

Bronze Finish (-710)
 Satin Etched Inner Glass, Clear Outer Glass



H

Bronze Finish (-710)
 Satin Etched Inner Glass,
 Off White Organza Silk Outer Shade



F

Bronze Finish (-710)
 Satin Etched Inner Glass,
 Off White Organza Silk Outer Shade



I

Bronze Finish (-710)
 Satin Etched Inner Glass, Clear Outer Glass

J. FOUR LIGHT WALL / BATH

W: 31.25" H: 8.5" E: 6.25"
 Height from center of outlet box
 up: 6.25" down: 2.25"

DAMP +

4437304(-962 -710)

(4) Medium Base 75W max.
 T24-1

4437304EN3(-962 -710)

(4) Med. Base LED 3000K,
 9W, 800 Lumen lamps incl.
 T24-2 EN *



J

Brushed Nickel Finish (-962)
 Satin Etched Inner Glass, Clear Outer Glass

K. THREE LIGHT WALL / BATH

W: 22.25" H: 8.5" E: 6.25"
 Height from center of outlet box
 up: 6.25" down: 2.25"

DAMP +

4437303(-962 -710)

(3) Medium Base 75W max.
 T24-1

4437303EN3(-962 -710)

(3) Med. Base LED 3000K,
 9W, 800 Lumen lamps incl.
 T24-2 EN *



K

Bronze Finish (-710)
 Satin Etched Inner Glass, Clear Outer Glass

L. TWO LIGHT WALL / BATH

W: 13.25" H: 8.5" E: 6.25"
 Height from center of outlet box
 up: 6.25" down: 2.25"

DAMP +

4437302(-962 -710)

(2) Medium Base 75W max.
 T24-1

4437302EN3(-962 -710)

(2) Med. Base LED 3000K,
 9W, 800 Lumen lamps incl.
 T24-2 EN *



L

Brushed Nickel Finish (-962)
 Satin Etched Inner Glass, Clear Outer Glass

M. ONE LIGHT WALL / BATH SCONCE

W: 4.5" H: 8" E: 6.25"
 Height from center of outlet box
 up: 5" down: 3"

DAMP +

4137301(-962 -710)

(1) Medium Base 75W max.
 T24-1

4137301EN3(-962 -710)

(1) Med. Base LED 3000K,
 9W, 800 Lumen lamps incl.
 T24-2 EN *



M

Bronze Finish (-710)
 Satin Etched Inner Glass, Clear Outer Glass

FINISH CODES

- (-962) Brushed Nickel
- (-710) Bronze



PRODUCT SHOWN: EMMONS SMALL THREE LIGHT CHANDELIER IN BRUSHED NICKEL FINISH

A. LARGE NINE LIGHT CHANDELIER

D: 35" H: 35"
10' Wire pre-laced through 6' Chain

DAMP

3139009-962

(9) Medium Base 75W max.

T24-1

3139009EN3-962

(9) Med. Base LED 3000K, 9W, 800 Lumen lamps incl.

T24-2 EN*

B. MEDIUM FIVE LIGHT CHANDELIER

D: 24" H: 26.75"
10' Wire pre-laced through 6' Chain

DAMP

3139005-962

(5) Medium Base 75W max.

T24-1

3139005EN3-962

(5) Med. Base LED 3000K, 9W, 800 Lumen lamps incl.

T24-2 EN*

C. SMALL THREE LIGHT CHANDELIER

D: 19.5" H: 22.5"
6' Wire pre-laced through 3' Chain

DAMP

3139003-962

(3) Medium Base 75W max.

T24-1

3139003EN3-962

(3) Med. Base LED 3000K, 9W, 800 Lumen lamps incl.

T24-2 EN*



A

Brushed Nickel Finish (-962)
Satin Etched Glass



B

Brushed Nickel Finish (-962)
Satin Etched Glass



C

Bronze Finish (-710)
Satin Etched Glass

FINISH CODE

(-962) Brushed Nickel

D. LARGE THREE LIGHT PENDANT

D: 17.75" H: 22.5"
10' Wire pre-laced through 6' Chain

DAMP

6639003-962

(3) Medium Base 75W max.

T24-1

6639003EN3-962

(3) Med. Base LED 3000K,
9W, 800 Lumen lamps incl.

T24-2 EN *



D

Brushed Nickel Finish (-962)
Satin Etched Glass



E

Brushed Nickel Finish (-962)
Satin Etched Glass

E. ONE LIGHT MINI-PENDANT

D: 6" H: 5.75"
6' Wire, (3) 12" Stems, (1) 6" Stem
Sloped Ceiling Mounting Hardware incl.

DAMP

6139001-962

(1) Medium Base 75W max.

T24-1

6139001EN3-962

(1) Med. Base LED 3000K,
9W, 800 Lumen lamp incl.

T24-2 EN *

F. MEDIUM TWO LIGHT SEMI-FLUSH MOUNT

D: 13" H: 9"

DAMP

7739002(-962 -710)

(2) Medium Base 75W max.

T24-1

7739002EN3(-962 -710)

(2) Med. Base LED 3000K,
9W, 800 Lumen lamps incl.

T24-2 EN *



F

Brushed Nickel Finish (-962)
Satin Etched Glass



Bronze Finish (-710)
Satin Etched Glass

FINISH CODES

(-962) Brushed Nickel
(-710) Bronze

G. FOUR LIGHT WALL / BATH

W: 32" H: 6.25" E: 7.5"
 Height from center of outlet box
 up: 3.75" down: 2.5"

DAMP +

4439004(-962 -710)

(4) Medium Base 75W max.

T24-1

4439004EN3(-962 -710)

(4) Med. Base LED 3000K,
 9W, 800 Lumen lamps incl.

T24-2 EN*



G

Brushed Nickel Finish (-962)
 Satin Etched Glass

H. THREE LIGHT WALL / BATH

W: 23.25" H: 6.25" E: 7.5"
 Height from center of outlet box
 up: 3.75" down: 2.5"

DAMP +

4439003(-962 -710)

(3) Medium Base 75W max.

T24-1

4439003EN3(-962 -710)

(3) Med. Base LED 3000K,
 9W, 800 Lumen lamps incl.

T24-2 EN*



H

Bronze Finish (-710)
 Satin Etched Glass

I. TWO LIGHT WALL / BATH

W: 14.75" H: 6.25" E: 7.5"
 Height from center of outlet box
 up: 3.75" down: 2.5"

DAMP +

4439002(-962 -710)

(2) Medium Base 75W max.

T24-1

4439002EN3(-962 -710)

(2) Med. Base LED 3000K,
 9W, 800 Lumen lamps incl.

T24-2 EN*



I

Brushed Nickel Finish (-962)
 Satin Etched Glass

J. ONE LIGHT WALL / BATH SCONCE

W: 6" H: 6.25" E: 7.5"
 Height from center of outlet box
 up: 3.75" down: 2.5"

DAMP +

4139001(-962 -710)

(1) Medium Base 75W max.

T24-1

4139001EN3(-962 -710)

(1) Med. Base LED 3000K,
 9W, 800 Lumen lamp incl.

T24-2 EN*



J

Bronze Finish (-710)
 Satin Etched Glass

FINISH CODES

(-962) Brushed Nickel
 (-710) Bronze

A. MEDIUM ONE LIGHT PENDANT

D: 15.75" H: 8.5"
 10' of wire pre-laced through 6' of chain
 DAMP

6516501(-05 -962 -710 -112 -848)

(1) Medium Base 75W max.
 T24-1

6516501EN3(-05 -962 -710 -112 -848)

(1) Med. Base LED 3000K,
 9W, 800 Lumen lamp incl.
 T24-2 EN*



A

Chrome Finish (-05)
 Satin Etched Glass



Bronze Finish (-710)
 Satin Etched Glass

B. MEDIUM THREE LIGHT PENDANT

D: 18.625" H: 20.625"
 10' Wire pre-laced through 6' Chain
 DAMP

6616503(-962 -710 -112 -848)

(3) Medium Base 75W max.
 T24-1

6616503EN3(-962 -710 -112 -848)

(3) Med. Base LED 3000K,
 9W, 800 Lumen lamps incl.
 T24-2 EN*



B

Midnight Black Finish (-112)
 Satin Etched Glass



Brushed Nickel (-962)
 Satin Etched Glass



Satin Brass Finish (-848)
 Satin Etched Glass

FINISH CODES

- (-05) Chrome
- (-962) Brushed Nickel
- (-710) Bronze
- (-112) Midnight Black
- (-848) Satin Brass

**C. MEDIUM THREE LIGHT
SEMI-FLUSH / PENDANT**

D: 18.625" H: 16.375" Semi-Flush H: 14.875"
6' Wire pre-laced through 3' Chain

DAMP +

7716503(-962 -710 -112 -848)

(3) Medium Base 75W max.

T24-1

7716503EN3(-962 -710 -112 -848)

(3) Med. Base LED 3000K,
9W, 800 Lumen lamps incl.

T24-2 EN*



C

Shown as Semi-Flush
Midnight Black Finish (-112)
Satin Etched Glass



D

Shown as Semi-Flush
Satin Brass Finish (-848)
Satin Etched Glass

**D. SMALL TWO LIGHT
SEMI-FLUSH / PENDANT**

D: 13.875" H: 12.375" Semi-Flush 11.375"
6' Wire pre-laced through 3' Chain

DAMP +

7716502(-962 -710 -112 -05 -848)

(2) Medium Base 75W max.

T24-1

7716502EN3(-962 -710 -112 -05 -848)

(2) Med. Base LED 3000K,
9W, 800 Lumen lamps incl.

T24-2 EN*



Chrome Finish (-05)
Satin Etched Glass



Satin Brass Finish (-848)
Satin Etched Glass



Brushed Nickel Finish (-962)
Satin Etched Glass



Midnight Black Finish (-112)
Satin Etched Glass

FINISH CODES

- (-962) Brushed Nickel
- (-710) Bronze
- (-112) Midnight Black
- (-05) Chrome
- (-848) Satin Brass



PRODUCT SHOWN: ROME SMALL THREE
LIGHT LANTERN IN CHROME FINISH

528 **GENERATION LIGHTING**

RESOURCES

ELECTRONIC TRANSFORMERS

Electronic transformers range in size from single output 60w (Class II), single output 150w zero-load, and single output 150w (Class I). Our transformers run quiet, are instant-on, feature fire-rated housings and dim easily with electronic low-voltage (ELV) dimmers. Generation Lighting Electronic Transformers specify whether they have a minimum load requirement — starting at 15w — or whether they are zero-load capable. Zero-load transformers have been designed for the low wattage draws of LED technology. For proper operation of an electronic transformer, the wattage load must fall within the specified range. Generation Lighting Electronic Transformers are moisture and shock resistant, featuring soft start circuitry for increased lamp life. Electronic transformers, as with many electronic components, may cause radio frequency interference (RFI). Our Electronic Transformers have built-in filters to help eliminate RFI. Should RFI be noticeable, rotate the unit to change the direction of the electronic field or replace with a magnetic transformer, which will not cause RFI.

MAGNETIC TRANSFORMERS

Generation Lighting laminated magnetic transformers are core and coil, isolated type transformers. We offer several sizes of laminated magnetic transformers ranging from 75 to 300w at 12v, and 60 to 200w at 24v in either AC or DC. Each transformer features thermal protection on the primary (120v) side. Our laminated magnetic transformers have resettable thermal circuit breakers on the low voltage side. Other features include a faraday shield, potted and encased core and coil for added safety and ease of installation. A boost tap is integrated to single-tap magnetic transformers to compensate for voltage drop. For optimum operation we recommend the load on all laminated magnetic transformers be between 50 and 100% of the rated wattage when used with xenon and halogen light sources. Magnetic transformers are zero load with LED lamp source. Not meeting minimum recommend loads can overdrive luminaires and greatly reduce lamp life. Be sure to keep insulation away from transformers. Magnetic transformers should be mounted vertically. If the transformer must be mounted horizontally, the ambient temperature must be below 120°F and the maximum load should be reduced to 80% of output.

OPERATING TEMPERATURES

Generation Lighting systems require adequate ventilation to dissipate heat generated during their operation. Care must be taken to avoid installing the system in confined areas where excessive heat may result in the transformer circuit breaker tripping or causing damage to the system and/or the area being illuminated. Surface temperatures on transformers, wiring and luminaires must not exceed 90°C (194°F).

DIMMING

When dimming a low-voltage system, it is recommended that the dimming occur on the primary side of the transformer, reducing the power coming into the transformer. The dimmer must be matched to the type of transformer that's powering the system.

- For electronic transformers use an electronic low voltage (ELV) dimmer.
- For magnetic transformers use a standard, incandescent line voltage dimmer or a magnetic low voltage (MLV) dimmer.

REMOTE MOUNTING

When a transformer needs to be mounted in a remote location, a properly sized jumper Wire (the cable between the transformer and the start of the lighting run, or between two illuminated sections) must be used. The jumper Wire can be Generation Lighting Cable run in additional protection (9435 track and 9439 cover or listed conduit), Romex or Type AC. Be sure to check with your local electrical inspector. The jumper Wire and lighting run must be connected in an approved wiring compartment, such as 9459 (-xx) or 9481 (-xx).

POWERING SYSTEMS

We recommend all systems used with Generation Lighting Systems be powered on the line voltage (120v or primary) side of the connection for optimum performance and safety. For applications which require operating to be done on the low voltage (secondary) side of the connection, there are two factors which need to be considered:

- It is very important that the switch used is rated for the amperage created; and
- Meet minimum load on electronic transformer To calculate amperage, use the following formula: Amperage = Wattage / Voltage

VOLTAGE DROP

Voltage drop is the difference between voltage of luminaires close to the transformer and luminaires at the end of an illuminated section.

- All lamp sources function optimally with no more than 10% voltage drop. Voltage outside of this range will affect lamp life and overall performance.
- To compensate for voltage drop, please calculate as stated below and use appropriate Wire.

CALCULATING VOLTAGE DROP:

Step 1:

Amps (Watts/Voltage) x Run/Length x 2 (for AC circuit) x Resistance per Foot(1) = Voltage Drop (in Volts)

Step 2:

- For 12v systems add voltage drop to 12 to determine tap to use.
- For 24v systems add voltage drop to 24 to determine tap to use.

RESISTANCE PER FOOT CHART

Wire Size	Resistance
4	0.000249
6	0.000395
8	0.000640
10*	0.001080
12	0.001620
14	0.002525
16	0.004016
18	0.006385

*Size of 10/2 AWG Generation Lighting Cable

Electronic AC Transformers

Part Number	Name	AC/DC	Type	Voltage	Connection (Hardware, Plug-in)
96622S-12	75W 12v Zero-Load Transformer	AC	Electronic	120v/12v	Hard-Wire
96624S-12	150w 12v Zero-Load Transformer	AC	Electronic	120v/12v	Hard-Wire
96623S-12	75W 24v Zero-Load Transformer	AC	Electronic	120v/24v	Hard-Wire

Magnetic AC Transformers

Part Number	Name	AC/DC	Type	Connection
94458-12	75W, 12v Magnetic Transformer	AC	Magnetic	Hard-Wire
94460-12	150w, 12v Magnetic Transformer	AC	Magnetic	Hard-Wire
94462-12	300w, 12v Magnetic Transformer	AC	Magnetic	Hard-Wire
94461-12	250w, 24v Magnetic Transformer	AC	Magnetic	Hard-Wire

Electronic DC Transformers

Part Number	Name	AC/DC	Type	Connection
98745S-12	60W 24v DC Transformer	DC	Electronic	Hard-Wire
98746S-12	105w 24v DC Transformer	DC	Electronic	Hard-Wire
98747S-12	150w 24v DC Transformer	DC	Electronic	Hard-Wire

Magnetic DC Transformers

Part Number	Name	AC/DC	Type	Connection
98743S-12	200w 24v DC Magnetic Transformer, Wet or Dry Location	DC	Magnetic	Hard-Wire











	Wattage	Primary Voltage (in)	Secondary Voltage (out)	Minimum Load (electronic only)	Dimensions	Listing
	75W	120v	12v	Zero Load	L: 7.805" W: 1.36" H: 0.949"	cETL dry
	150w	120v	12v	Zero Load	L: 8.385" W: 2.53" H: 1.219"	cETL dry
	75W	120v	24v	Zero Load	L: 7.805" W: 1.36" H: 0.949"	cETL dry

	Wattage	Primary Voltage (in)	Secondary Voltage (out)	Minimum Load (electronic only)	Dimensions	Listing
	75W	120v	12v	N/A	L: 8.75" W: 4.25" H: 3.75"	cUL Dry
	150w	120v	12v	N/A	L: 10.5" W: 4.313" H: 4.313"	cUL Dry
	300w	120v	12v	N/A	L: 10.563" W: 4.375" H: 3.875"	cUL Dry
	250w	120v	24v	N/A	L: 10.75" W: 4.5" H: 4.25"	cUL Dry

	Wattage	Primary Voltage (in)	Secondary Voltage (out)	Minimum Load (electronic only)	Dimensions	Listing
	60W	120v	24v	Zero Load	L: 9.5" W: 4.125" H: 2.125"	cETL DAMP
	105w	120v	24v	Zero Load	L: 9.5" W: 4.125" H: 2.125"	cETL DAMP
	150w	120v	24v	Zero Load	L: 9.5" W: 4.125" H: 2.125"	cETL DAMP

	Wattage	Primary Voltage (in)	Secondary Voltage (out)	Minimum Load (electronic only)	Dimensions	Listing
	200w	120v	24v	N/A	L: 8.875" W: 4.375" H: 4"	cETL WET

LAMP REFERENCE CHART RESOURCES

	Item Number	Wattage	Voltage	Light Output (Lumens)	Efficacy (LM/W)	Lamp Type	Base Type	Light Source	Color Temperature
	97500S	6.5	120V	650	100	Vintage ST19	Medium	LED	2300K
	S39188	6.5	120V	180	N/A	1-PAR20	Medium	LED	N/A
	97531S	3.5	120V	160	45.7	T6	Candelabra	LED	2200K
	97532S	3.5	120V	160	45.7	T6	Candelabra	LED	2700K
	97541S	3.5	120V	300	66.7	T14	Medium	LED	2200K
	97542S	3.5	120V	300	66.7	T14	Medium	LED	2700K
	97512S	9	120V	800	80	A19	Medium	LED	2700K
	LTB10C35027CB	3.5	120V	350	100	B10	Candelabra	LED	2700K
	9728	5	12V AC	23	6	T3 ¹ / ₄	Wedge	Incandescent	2300K
	9731	3	12V AC	15	6	T3 ¹ / ₄	Wedge	Xenon	2400K
	9732	5	12V AC	33	8	T3 ¹ / ₄	Wedge	Xenon	2550K
	9774	18	12V AC	210	13	T ⁵	Wedge	Xenon	2800K
	9777	12	12V AC	120	10	T ⁵	Wedge	Incandescent	2750K
	96116S-32	.708	12V AC	59	83	T ³	Festoon	LED	2700K
	96116S-33	.708	12V AC	59	83	T ³	Festoon	LED	2700K
	96118S-32	.708	12V AC	60	85	T ³	Festoon	LED	3000K
	96118S-33	.708	12V AC	60	85	T ³	Festoon	LED	3000K
	97118-32	5	12V AC	33	8	T ³	Festoon	Xenon	2550K
	97118-33	5	12V AC	33	8	T ³	Festoon	Xenon	2550K
	97119-32	10	12V AC	83	10	T ³	Festoon	Xenon	2650K
	97119-33	10	12V AC	83	10	T ³	Festoon	Xenon	2650K

	Beam Spread	CRI	Rated Life (Hours)	Comparable Equivalent	Warranty	Dimmable	Certification	Dimensions	Energy Star	Location Rating
	360°	80	15,000	60w Incandescent	3-Year Ltd.	Yes*	RoHS	D: 2.375" L: 5.375"	—	
	40°	--	25,000	50w Incandescent	3-Year Ltd.	No	RoHS	D: 2.5" L: 3.25"	—	
	360°	90	15,000	40w Incandescent	3-Year Ltd.	Yes*	RoHS	D: .75" L: 3.25"	—	encl.
	360°	90	15,000	40w Incandescent	3-Year Ltd.	Yes*	RoHS	D: .75" L: 3.25"	—	encl.
	360°	90	15,000	60w Incandescent	3-Year Ltd.	Yes*	RoHS	D: 1.75" L: 4.2"	—	encl.
	360°	90	15,000	60w Incandescent	3-Year Ltd.	Yes*	RoHS	D: 1.75" L: 4.2"	—	encl.
	300°	90	25,000	60w Incandescent	5-Year Ltd.	Yes*	RoHS	D: 2.36" L: 4.37"	CEC	
	300°	90	25,000	40w Incandescent	3-Year Ltd.	Yes*	RoHS	D: 1.25" L: 4.25"	CEC	encl.
	—	90	9,000	—	1-Year Ltd.	Yes*	RoHS	D: .406" L: .906"	—	
	—	90	19,000	—	1-Year Ltd.	Yes*	RoHS	D: .406" L: .906"	—	
	—	90	8,000	—	1-Year Ltd.	Yes*	RoHS	D: .406" L: .906"	—	
	—	90	10,000	—	1-Year Ltd.	Yes*	RoHS	D: .594" L: 1.406"	—	
	—	90	2,000	—	1-Year Ltd.	Yes*	RoHS	D: .594" L: 1.406"	—	
	—	90	50,000 to 70%	—	3-Year Ltd.	Yes*	RoHS	D: .466" L: 1.649"	—	
	—	90	50,000 to 70%	—	3-Year Ltd.	Yes*	RoHS	D: .466" L: 1.649"	—	
	—	90	50,000 to 70%	—	3-Year Ltd.	Yes*	RoHS	D: .466" L: 1.649"	—	
	—	90	50,000 to 70%	—	3-Year Ltd.	Yes*	RoHS	D: .466" L: 1.649"	—	
	—	90	16,000	—	1-Year Ltd.	Yes*	RoHS	D: .375" L: 1.687"	—	—
	—	90	16,000	—	1-Year Ltd.	Yes*	RoHS	D: .375" L: 1.687"	—	—
	—	90	12,000	—	1-Year Ltd.	Yes*	RoHS	D: .375" L: 1.687"	—	—
	—	90	12,000	—	1-Year Ltd.	Yes*	RoHS	D: .375" L: 1.687"	—	—

* When dimming LED light sources, derate your dimmer to 25% of its rated capacity. For example, a 600 watt dimmer should be derated to 150 watt capacity. Consult your dimmer manufacturer for more information and restrictions.



PRODUCT SHOWN: JONAH MEDIUM CHANDELIER
IN SATIN NICKEL/CHROME FINISH

TO ORDER ADDITIONAL CHAIN OR STEMS:

1. Locate the row for your collection and fixture.
2. Write down the style number in the Chain or Stem column.
3. Replace the "xxx" with the desired finish code from Finishes Available column.

Family	Chain	Stems	Sloped Ceiling Mounting Hardware	Finishes Available
Alturas	9100-xxx	9199-xxx	9122-xxx	Brushed Nickel (-962), Satin Brass (-848), Midnight Black (-112)
Ansley	—	STEMKIT-12-xxx	—	Aged Iron (AI)
Bakersville	9100-xxx	—	—	Antique Bronze (-71), Black (-12)
Belton	—	9199-xxx	9122-xxx	Brushed Nickel (-962), Bronze (-710), Midnight Black (-112)
Brentwood	9103-12	—	—	Black (-12)
Cadence	CHAIN SQ DAB	—	—	Dark Antique Brass / Matte Black (DAB/MB)
Canfield	9100-xxx	9199-xxx	9122-xxx	Brushed Nickel (-962), Bronze (-710), Midnight Black (-112)
Cape May	9100-xxx	—	—	Burled Iron (-780), Black (-12)
Chateau	CHAIN xxx	—	—	Mocha Bronze (MBZ)
Cotswold Lane	CHAIN xxx	—	—	Black (BK), Grecian Bronze (GBZ)
Dawes	—	9199-xxx	9122-xxx	Brushed Nickel (-962), Bronze (-710)
Driscoll	9100-xxx	—	—	Brushed Nickel (-962), Satin Brass (-848)
Dunning	9103-846	9199-846	9122-846	Stardust (-846)
Ellis Harper	—	9199-962	9122-962	Brushed Nickel (-962)
Elmwood Park	9100-xxx	9199-xxx	9122-xxx	Brushed Nickel (-962), Bronze (-710)
Emmons (3139012-xxx)	9107-xxx	—	—	Brushed Nickel (-962), Bronze (-710)
Emmons (All others)	9100-xxx	9199-xxx	9122-xxx	Brushed Nickel (-962)
Ethan	—	STEMKIT-12-AF	—	(Antique Forged Iron/Brushed Steel (AF/BS))
Franport (3128909-xxx)	9116-xxx	—	—	Brushed Nickel (-962), Bronze (-710)
Franport (All others)	9100-xxx	—	—	Brushed Nickel (-962), Bronze (-710)
Fredricksburg	—	9199-xxx	9122-xxx	Weathered Copper (-44), Satin Aluminum (-04), Black (-12)
Geary	9100-xxx	—	—	Chrome (-05), Bronze (-710), Midnight Black (-112), Brushed Nickel (-962), Satin Brass (-848)
Hanford (3124515-xxx)	9116-xxx	—	—	Brushed Nickel (-962)
Hanford (All others)	9100-xxx	9199-xxx	9122-xxx	Brushed Nickel (-962), Bronze (-710)

*Accessories come in accent finish.

Family	Chain	Stems	Sloped Ceiling Mounting Hardware	Finishes Available
Herrington	9103-12	—	—	Black (-12)
Hettinger	9100-xxx	9199-xxx	9122-xxx	Brushed Nickel (-962)
Hunnington	9100-xxx	—	—	Black (-12), Weathered Pewter (-57)
Jonah	—	STEMKIT-58-xxx	—	Satin Nickel/Chrome (SN/CH)
Kea	—	9199-xxx	9122-xxx	Brushed Nickel (-962), Bronze (-710)
Kemal (3130709-xxx)	9116-xxx	—	—	Brushed Nickel (-962), Midnight Black (-112)
Kemal (All Others)	9100-xxx	9199-xxx	9122-xxx	Brushed Nickel (-962), Midnight Black (-112)
Kent	9103-xxx	—	—	Black (-12), Oxford Bronze (-746)
Kerrville	9100-xxx	9199-xxx	9122-xxx	Chrome (-05), Brushed Nickel (-962), Bronze (-710)
Labette	9100-xxx	—	—	Black (-12)
Lancaster	9100-xxx	—	—	Antique Bronze (-71), Antique Brushed Nickel (-965), Black (-12), Polished Brass (-02)
Loras	CHAIN-xxx	—	—	Chrome (CH), Dark Weathered Iron (DWI)
Marielle	CHAIN-xxx	—	—	Antique Gild (ADB)
Martinsville	CHAIN xx	—	—	Black (BK), Corinthian Bronze (CB)
Millbrooke	CHAIN BK	—	—	Antique Bronze (ANBZ)
Mitte	—	9199-112	—	Midnight Black (-112)
Moffet Street	—	9199-xxx	9122-xxx	Chrome (-05)*, Brushed Nickel (-962), Satin Brass (-848), Bronze (-710)
Nance	9100-xxx	9199-xxx	9122-xxx	Brushed Nickel (-962), Bronze (-710)
Oslo (66160-xxx)	—	9196-xxx	—	Chrome (-05), Brushed Nickel, (-962), Midnight Black (-112), Bronze (-710)
Oslo (31162-xxx)	9116-xxx	—	—	Chrome (-05), Brushed Nickel, (-962), Midnight Black (-112), Bronze (-710)
Oslo (All others)	9100-xxx	9199-xxx	9122-xxx	Chrome (-05), Brushed Nickel, (-962), Midnight Black (-112), Bronze (-710)
Perryton	—	9199-xxx	9122-xxx	Chrome (-05), Satin Brass (-848), Bronze (-710), Midnight Black (-112)
Pratt Street Metal	—	9199-xxx	9122-xxx	Brushed Nickel (-962), Autumn Bronze (-715)
Pratt Street Prismatic	—	9199-xxx	9122-xxx	Brushed Nickel (-962), Autumn Bronze (-715)
Ravenwood Manor	9103-846	9199-846	—	Stardust (-846)
Redding Station	CHAIN-xxx	—	—	Restoration Bronze (RSZ), Tarnished Silver (TRD), Textured Black (TXB)
Robie (3121612-xxx)	9116-xxx	—	—	Brushed Nickel (-962), Bronze (-710), Midnight Black (-112)

*Accessories come in accent finish.

Family	Chain	Stems	Sloped Ceiling Mounting Hardware	Finishes Available
Robie (All others)	9100-xxx	9199-xxx	9122-xxx	Brushed Nickel (-962), Bronze (-710), Midnight Black (-112)
Romee	9100-xxx	—	—	Chrome (-05), Brushed Nickel (-962), Bronze (-710)
Sevier	9100-xxx	—	—	Black (-12), Antique Bronze (-71)
Seville	9100-xxx	9199-xxx	9122-xxx	Brushed Nickel (-962), Bronze (-710)
Socorro	9100-xxx	9199-xxx	9122-xxx	Stardust (-846)
Stone Street	—	9199-xxx	9122-xxx	Brushed Nickel (-962)
Towner	—	9199-xxx	9122-xxx	Brushed Nickel (-962), Satin Brass (-848)
Tybee	9100-xxx	—	—	Black (-12), Antique Bronze (-71)
Urban Renewal	—	STEMKIT-12-xxx	—	Dark Antique Brass (DAB), Oil Rubbed Bronze (ORB), Rustic Iron (RI)
Vado	—	9199-xxx	—	Black (-12), Antique Bronze (-71)
Valentina	CHAIN xxx	—	—	Oxidized Bronze (OBZ)
Wilburn	9100-xxx	—	—	Antique Bronze (-71), Black (-12)
Windom	9100-xxx	9199-xxx	9122-xxx	Brushed Nickel (-962), Satin Brass (-848), Bronze (-710), Midnight Black (-112)

*Accessories come in accent finish.

DECORATIVE WIRE EXTENDER

L: 0.812" W: 0.562" H: 0.5"
Wattage: 600w max.

9032(-24 -12)

Snap together splicer/Wire extender for 18/2 SPT 11/2 and ground Wire. Corrosion resistant contacts simply pierce the conductors for the electrical connection. Fits into a link of Chain. Must be used with approved Chain only.



9032-24
Grey Finish



9032-12
Black Finish

INDEX

11018	458	31171(-112 -710 -962)	472	3130709EN3(-962 -112)	496	3JVR44RZWD	361
11019	457	31171EN7(-112 -710 -962)	472	3137303(-962 -710)	519	3JVR52AGP	360
11028QC	456	31172(-112 -710 -962)	472	3137303EN3(-962 -710)	519	3JVR52AGPD	359
11033AT-15	456, 457, 458	31172EN7(-112 -710 -962)	472	3137305(-962 -710)	519	3JVR52BS	360
1109	459	3120203(-962 -710)	475	3137305EN3(-962 -710)	519	3JVR52BSD	359
1115	453	3120203EN3(-962 -710)	475	3137309(-962 -710)	519	3JVR52MBK	360
1121-14	459	3120205(-962 -710)	475	3137309EN3(-962 -710)	519	3JVR52MBKD	359
1126-14	455	3120205EN3(-962 -710)	475	3139003-962	523	3JVR52RZW	360
1128	455	3120209(-962 -710)	475	3139003EN3-962	523	3JVR52RZWD	359
1133AT-15	455	3120209EN3(-962 -710)	475	3139005-962	523	3JVR58AGP	357, 391
1151AT-14	455, 456, 458	3121603(-962 -710 -112)	512	3139005EN3-962	523	3JVR58AGPD	356, 390
1152AT-15	453, 454	3121603EN3(-962 -710 -112)	512	3139009-962	523	3JVR58BS	357
1153AT-15	453, 454	3121605(-962 -710 -112)	511	3139009EN3-962	523	3JVR58BSD	356
1154AT-14	455, 456, 458	3121605EN3(-962 -710 -112)	511	3139106-962	501	3JVR58MBK	357, 391
1155AT-15	455	3121609(-962 -710 -112)	511	3139106EN3-962	501	3JVR58MBKD	356, 390
1156AT-14	453, 454	3121612(-962 -710 -112)	511	3139109-962	501	3JVR58RZW	357, 391
1158AT-14	457	3121612EN3(-962 -710 -112)	511	3139109EN3-962	501	3JVR58RZWD	356, 390
1162AT-14	453, 454	3124503-962	515	3140403(-848 -962)	92	3LD48BS	389
1166AT-15	453, 454	3124503EN3-962	515	3140403EN3(-848 -962)	92	3LD48BSD	388
1179	454	3124505-962	515	3140405EN3(-848 -962)	92	3LD48BZ	389
14210S-15	449	3124505EN3-962	515	3141303-848	95	3LD48BZD	388
14550S-15	448	3124509-962	515	3141303EN3-848	95	3LD48MBK	389
14620S-15	447	3124509EN3-962	515	3141305(-848 -962)	95	3LD48MBKD	388
14795	448	3124603(-848 -962 -112)	99, 463	3141305EN3(-848 -962)	95	3LD48RZW	389
14825RD-15	446	3124603EN3(-848 -962 -112)	99, 463	3141307(-848 -962)	95	3LD48RZWD	388
14827RD-15	446	3124605(-848 -962 -112)	99, 463	3141307EN3(-848 -962)	95	3OBSHR52BSD	373
14916RD-15	444	3124605EN3(-848 -962 -112)	99, 463	3214505(-962 -710 -112)	489	3OBSHR52MBKD	373
149212RD-15	446	3124609(-848 -962 -112)	99, 463	3214505EN7(-962 -710 -112)	489	3OBSHR52RZWD	373
14929RD-15	446	3124609EN3(-848 -962 -112)	99, 463	3214509(-962 -710 -112)	488	3OBSHR52SBD	373
14936RD-15	445	3124673(-112 -848 -962)	101, 465	3214509EN7(-962 -710 -112)	488	3OBSR52BSD	372
3102803(-962 -848 -710 -112)	481	3124673EN7(-112 -848 -962)	101, 465	3224906-846	113	3OBSR52MBKD	372
3102803EN3(-962 -848 -710 -112)	481	3124675(-112 -848 -962)	101, 465	3224906EN-846	113	3OBSR52RZWD	372
3102805(-962 -848 -710 -112)	481	3124675EN7(-112 -778 -848 -962)	101	3320205(-962 -710)	476	3OBSR52SBD	372
3102805EN3(-962 -848 -710 -112)	481	3124675EN7(-112 -848 -962)	465	3320205EN(-962 -710)	476	3SY52BSD	374
3102809(-962 -848 -710 -112)	481	3124679(-112 -848 -962)	100, 464	3ERAR44AGPD	366	3SY52MBKD	374
3102809EN3(-962 -848 -710 -112)	481	3124679EN7(-112 -848 -962)	100, 464	3ERAR44BSD	366	3SY52OZD	374
3110205-846	106	3124904-846	113	3ERAR44MBKD	366	3SY52RZWD	374
3110208-846	129	3124904EN-846	113	3ERAR44RZWD	366	3TTHR44BSD	369
3110209-846	106	3124906-846	113	3ERAR52AGP	364	3TTHR44MBKD	369
3113704-962	504	3124906EN-846	113	3ERAR52BSD	364	3TTHR44RZWD	369
3113704EN3-962	504	3128803(-962 -710 -112)	493	3ERAR52MBKD	364	3TTHR44SBD	369
3113708-962	504	3128803EN3(-962 -710 -112)	493	3ERAR52RZWD	364	3TTHR52BSD	368
3113708EN3-962	504	3128805(-962 -710 -112)	493	3ERHR44AGPD	367	3TTHR52MBKD	368
3114503(-962 -710 -112)	489	3128805EN3(-962 -710 -112)	493	3ERHR44BSD	367	3TTHR52RZWD	368
3114503EN7(-962 -710 -112)	489	3128809(-962 -710 -112)	492	3ERHR44MBKD	367	3TTHR52SBD	368
3114505(-962 -710 -112)	489	3128809EN3(-962 -710 -112)	492	3ERHR44RZWD	367	4102801(-05 -962 -848 -710 -112)	215, 483
3114505EN7(-962 -710 -112)	489	3128903(-962 -710)	507	3ERHR52AGPD	365	4102801EN3(-05 -962 -848 -710 -112)	215, 483
3115209(-05 -962 -710)	484	3128903EN3(-962 -710)	507	3ERHR52BSD	365	41036-999	207
3115209EN3(-05 -962 -710)	484	3128905(-962 -710)	507	3ERHR52MBKD	365	41036EN3-999	207
31160(-05 -962 -112)	469	3128905EN3(-962 -710)	507	3ERHR52RZWD	365	4111601(-05 -962 -710)	243
31160EN3(-05 -962 -112)	469	3128909(-962 -710)	507	3JVR44AGP	363	4111601EN3(-05 -962 -710)	243
31161(-05 -962 -112)	469	3128909EN3(-962 -710)	507	3JVR44AGPD	361	4113701-962	233, 505
31161EN3(-05 -962 -112)	469	3130703(-962 -112)	497	3JVR44BS	363	4113701EN3-962	233, 505
31162(-05 -962 -112)	469	3130703EN3(-962 -112)	497	3JVR44BSD	361	4114501(-05 -962 -710 -112)	231, 491
31162EN3(-05 -962 -112)	469	3130705(-962 -112)	497	3JVR44MBK	363	4114501EN7(-05 -962 -710 -112)	231, 491
31170(-112 -710 -962)	472	3130705EN3(-962 -112)	497	3JVR44MBKD	361	4115201(-05 -962 -710)	230, 487
31170EN7(-112 -710 -962)	472	3130709(-962 -112)	496	3JVR44RZW	363	4115201EN3(-05 -962 -710)	230, 487

41160(-05 -962 -112)	471	4141501EN7-112	218	4424504(-962 -710)	244, 517	4440404EN3(-05 -848 -962)	227
41160(-05 -962 -710 -112)	222	4148-15	206	4424504EN3(-962 -710)	244, 517	4441302(-848 -962)	217
41160EN3(-05 -962 -112)	471	414893S-15	206	4424602(-05 -848 -962 -778 -112)	237, 467	4441302EN3(-848 -962)	217
41160EN3(-05 -962 -710 -112)	222	4148EN3-15	206	4424602EN3(-05 -848 -962 -778 -112)	237, 467	4441303(-848 -962)	217
41161(-05 -962 -112)	471	424504EN3(-962 -710)	517	4424603(-05 -848 -962 -778 -112)	237, 467	4441303EN3(-848 -962)	217
41161(-05 -962 -710 -112)	222	4322991S-962	249	4424603EN3(-05 -848 -962 -778 -112)	237, 467	4441304(-848 -962)	217
41161EN3(-05 -962 -112)	471	4402802(-05 -962 -848 -710 -112)	215, 483	4424604(-05 -848 -962 -778 -112)	237, 467	4441304EN3(-848 -962)	217
41161EN3(-05 -962 -710 -112)	222	4402802EN3(-05 -962 -848 -710 -112)	215, 483	4424604EN3(-05 -848 -962 -778 -112)	237, 467	4441502-112	218
41162(-05 -962 -112)	471	4402803(-05 -962 -848 -710 -112)	215, 483	4428802(-05 -962 -710 -112)	495	4441502EN7-112	218
41162(-05 -962 -710 -112)	222	4402803EN3(-05 -962 -848 -710 -112)	215, 483	4428802(-05 -962 -710)	225	4441503-112	218
41162EN3(-05 -962 -112)	471	4402804(-05 -962 -848 -710 -112)	215, 483	4428802EN3(-05 -962 -710 -112)	495	4441503EN7-112	218
41162EN3(-05 -962 -710 -112)	222	4402804EN3(-05 -962 -848 -710 -112)	215, 483	4428802EN3(-05 -962 -710)	225	4441504-112	218
41163(-05 -962 -112)	471	4411602(-05 -962 -710)	243	4428803(-05 -962 -710 -112)	495	4535793S-04	248
41163(-05 -962 -710 -112)	222	4411602EN3(-05 -962 -710)	243	4428803(-05 -962 -710)	225	4635793S-04	248
41163EN3(-05 -962 -112)	471	4411603(-05 -962 -710)	243	4428803EN3(-05 -962 -710 -112)	495	4737(-05 -98)	251
41163EN3(-05 -962 -710 -112)	222	4411603EN3(-05 -962 -710)	243	4428803EN3(-05 -962 -710)	225	4738(-05 -98)	251
41170(-05 -112 -710 -962)	223, 473	4411604(-05 -962 -710)	243	4428804(-05 -962 -710 -112)	495	4739(-05 -98)	250
41170EN7(-05 -112 -710 -962)	223, 473	4411604EN3(-05 -962 -710)	243	4428804(-05 -962 -710)	225	4740(-05 -98)	250
41171(-05 -112 -710 -962)	223, 473	4413702-962	233, 505	4428804EN3(-05 -962 -710 -112)	495	49119(-962 -710)	207
41171EN7(-05 -112 -710 -962)	223, 473	4413702EN3-962	233, 505	4428804EN3(-05 -962 -710)	225	49119EN3(-962 -710)	207
41172(-05 -112 -710 -962)	223, 473	4413703-962	505	4428902(-05 -962 -710 -112)	241, 509	49274S-15	410, 414
41172EN7(-05 -112 -710 -962)	223, 473	4413703(-05 -962 -778)	233	4428902EN3(-05 -962 -710 -112)	241, 509	49275S-15	410, 414
41173(-05 -112 -710 -962)	223, 473	4413703EN3-962	233, 505	4428903(-05 -962 -710 -112)	241, 509	49276S-15	410, 414
41173EN7(-05 -112 -710 -962)	223, 473	4413704-962	233, 505	4428903EN3(-05 -962 -710 -112)	241, 509	49277S-15	410, 414
4120201(-05 -962 -710)	229, 479	4413704EN3-962	233, 505	4428904(-05 -962 -710 -112)	241, 509	49278S-15	410, 414
4120201EN3(-05 -962 -710)	229, 479	4414502(-05 -962 -710 -112)	231, 491	4428904EN3(-05 -962 -710 -112)	509	4933593S-962	207
4121601(-05 -962 -710 -112)	238, 513	4414502EN7(-05 -962 -710 -112)	231, 491	4428904EN3(-05 -962 -710 -112)	241	49374S-15	410, 414
4121601EN3(-05 -962 -710 -112)	238, 513	4414503(-05 -962 -710 -112)	231, 491	4430702(-962 -710 -112)	232, 499	49375S-15	410, 414
4122991S-962	249	4414503EN7(-05 -962 -710 -112)	231, 491	4430702EN3(-962 -710 -112)	232, 499	49376S-15	410, 414
4123-15	206	4414504(-05 -962 -710 -112)	231, 491	4430703(-962 -710 -112)	232, 499	49377S-15	410, 414
4123EN3-15	206	4414504EN7(-05 -962 -710 -112)	231, 491	4430703EN3(-962 -710 -112)	232, 499	49378S-15	410, 414
4124501(-962 -710)	244, 517	441504EN7-112	218	4430704(-962 -710 -112)	232, 499	495193S-15	410, 414
4124501EN3(-962 -710)	244, 517	4415202(-05 -962 -710)	230, 487	4430704EN3(-962 -710 -112)	232, 499	495293S-15	410, 414
4124601(-05 -848 -962 -778 -112)	237, 467	4415202EN3(-05 -962 -710)	230, 487	4435793S-04	248	495393S-15	410, 414
4124601EN3(-05 -848 -962 -778 -112)	237, 467	4415203(-05 -962 -710)	230, 487	4437302(-962 -710)	224, 521	495493S-15	410, 414
4128801(-05 -962 -710 -112)	495	4415203EN3(-05 -962 -710)	230, 487	4437302EN3(-962 -710)	224, 521	495593S-15	410, 414
4128801(-05 -962 -710)	225	4415204(-05 -962 -710)	230, 487	4437303(-962 -710)	224, 521	495603S-15	415
4128801EN3(-05 -962 -710 -112)	495	4415204EN3(-05 -962 -710)	230, 487	4437303EN3(-962 -710)	224, 521	495606S-15	415
4128801EN3(-05 -962 -710)	225	4420202(-05 -962 -710)	229, 479	4437304(-962 -710)	224, 521	495612S-15	415
4128901(-05 -962 -710 -112)	241, 509	4420202EN3(-05 -962 -710)	229, 479	4437304EN3(-962 -710)	224, 521	495624S-15	415
4128901EN3(-05 -962 -710 -112)	241, 509	4420203(-05 -962 -710)	229, 479	4439002(-962 -710)	245, 525	495672S-15	415
4130701(-962 -710 -112)	232, 499	4420203EN3(-05 -962 -710)	229, 479	4439002EN3(-962 -710)	245, 525	495688S-15	415
4130701EN3(-962 -710 -112)	232, 499	4420204(-05 -962 -710)	228, 478	4439003(-962 -710)	245, 525	496624S-15	415
4137301(-962 -710)	224, 521	4420204EN3(-05 -962 -710)	228, 478	4439003EN3(-962 -710)	245, 525	4975BLE-15	412, 414
4137301EN3(-962 -710)	224, 521	4420205(-05 -962 -710)	228, 478	4439004(-962 -710)	245, 525	4976BLE-15	412, 414
4138-15	206	4420205EN3(-05 -962 -710)	228, 478	4439004EN3(-962 -710)	245, 525	4977BLE-15	412, 414
4138EN3-15	206	4421602(-05 -962 -710 -112)	238, 513	4439102(-05 -962 -710 -112 -848)	235, 503	5115004(-848 -05 -710 -112)	135
4139001(-962 -710)	245, 525	4421602EN3(-05 -962 -710 -112)	238, 513	4439102EN3(-05 -962 -710 -112 -848)	235, 503	5115004EN(-848 -05 -710 -112)	135
4139001EN3(-962 -710)	245, 525	4421603(-05 -962 -710 -112)	238, 513	4439103(-05 -962 -710 -112 -848)	235, 503	5115008(-848 -05 -710 -112)	134
4139101(-05 -962 -710 -112 -848)	235, 503	4421603EN3(-05 -962 -710 -112)	238, 513	4439103EN3(-05 -962 -710 -112 -848)	235, 503	5115008EN(-848 -05 -710 -112)	134
4139101EN3(-05 -962 -710 -112 -848)	503	4421604(-05 -962 -710 -112)	238, 513	4439104(-05 -962 -710 -112 -848)	235, 503	5126003(-962 -710)	143
4139101EN3(-05 -962 -710 -112 -848)	235	4421604EN3(-05 -962 -710 -112)	238, 513	4439104EN3(-05 -962 -710 -112 -848)	235, 503	5126003EN(-962 -710)	143
4140401(-05 -848 -962)	227	4422991S-962	249	4440402(-05 -848 -962)	227	5134503(-848 -962 -872 -710)	137
4140401EN3(-05 -848 -962)	227	4424502(-962 -710)	244, 517	4440402EN3(-05 -848 -962)	227	5134503EN(-848 -962 -872 -710)	137
4141301(-848 -962)	205, 217	4424502EN3(-962 -710)	244, 517	4440403(-05 -848 -962)	227	5134504(-848 -962 -872 -710)	137
4141301EN3(-848 -962)	205, 217	4424503(-962 -710)	244, 517	4440403EN3(-05 -848 -962)	227	5134504EN(-848 -962 -872 -710)	137
4141501-112	218	4424503EN3(-962 -710)	244, 517	4440404(-05 -848 -962)	227	5134508(-848 -962 -872 -710)	136

INDEX

5134508EN(-848 -962 -872 -710)	136	5CSM60AGPD-V1	380	5LWDR52AGPD	371	6139001-962	524
5134903(-05 -962 -710)	142	5CSM60BS	381	5LWDR52BSD	371	6139001EN3-962	524
5134903EN(-05 -962 -710)	142	5CSM60BSD-V1	380	5LWDR52BSLGD	371	6140401(-848 -962)	156
5134906(-05 -962 -710)	142	5CSM60MBK	381	5LWDR52MBKD	371	6140401EN(-848 -962)	156
5134906EN(-05 -962 -710)	142	5CSM60MBKD-V1	380	5LWDR52RZWD	371	6141301(-848 -962)	169
5134908(-05 -962 -710)	142	5CSM60RB	381	5LWDSM60AGPD	370	6141301EN3(-848 -962)	169
5134908EN(-05 -962 -710)	142	5CSM60RBD-V1	380	5LWDSM60BSD	370	62027(-57 -12)	326
5140603-12	141	5CSM60RZWD	381	5LWDSM60BSLGD	370	6208901(-12 -71)	271
5140603EN-12	141	5CSM60RZWD-V1	380	5LWDSM60MBKD	370	6208901EN7(-12 -71)	271
5141501-112	139	5CU52BK	395	5LWDSM60RZWD	370	62240(-780 -12)	282
5141501EN7-112	139	5CU52RB	395	60029(-746 -12)	295	62240EN3(-780 -12)	282
5215004(-848 -05 -710 -112)	135	5CU52WH	395	60029EN7(-746 -12)	295	6227801-112	490
5215004EN(-848 -05 -710 -112)	135	5DIC44AGPD-V1	379	60031(-746 -12)	295	6227801EN7-112	490
5224503-962	515	5DIC44BKD-V1	379	60031EN7(-746 -12)	295	6238701(-71 -12)	291
5224503EN3-962	515	5DIC44BSD-V1	379	6008(-02 -12)	303	6238701EN7(-71 -12)	291
5234508(-848 -962 -872 -710)	136	5DIC44PND-V1	379	6008EN7(-02 -12)	303	6238751(-71 -12)	288
5234508EN(-848 -962 -872 -710)	136	5DIC44RBD-V1	379	60131-12	297	6238751EN3(-71 -12)	288
5240603-12	141	5DIC44WHD-V1	379	60131EN7-12	297	6247701(-04 -44 -12)	171, 334
5240603EN-12	141	5DIC52AGPD-V1	378	6025-12	307	6247701EN3(-04 -44 -12)	171, 334
5241504-112	139	5DIC52BKD-V1	378	6025EN7-12	307	6290901(-71 -12)	269
5241504EN7-112	139	5DIC52BSD-V1	378	6039(-02 -965 -71 -12)	301	6290901EN3(-71 -12)	269
5315008(-848 -05 -710 -112)	134	5DIC52PND-V1	378	6039EN(-02 -965 -71 -12)	301	65060(-962 -715)	172
5315008EN(-848 -05 -710 -112)	134	5DIC52RBD-V1	378	60531(-746 -12)	293	65060EN3(-962 -715)	172
5326(-15 -962 -710)	192	5DIC52WHD-V1	378	60531EN3(-746 -12)	293	65061(-962 -715)	172
5326EN3(-15 -962 -710)	192	5DIO52AGPD	377	60938(-71 -12)	287	65061EN3(-962 -715)	172
5328(-15 -962 -710)	192	5DIO52BKD	377	60938EN7(-71 -12)	287	65062(-962 -715)	172
5328EN3(-15 -962 -710)	192	5DIO52RBD	377	60941(-71 -12)	286	65062EN3(-962 -715)	172
5340604-12	141	5DISM52AGPD	375	60941EN3(-71 -12)	286	65085(-848 -962 -715)	173
5340604EN-12	141	5DISM52BSD	375	6102801(-962 -848 -710 -112)	482	65085EN3(-848 -962 -715)	173
5341504-112	139	5DISM52MBKD	375	6102801EN3(-962 -848 -710 -112)	482	65086(-848 -962 -715)	173
5341504EN7-112	139	5DISM52RZWD	375	6113701(-962 -778)	504	65086EN3(-848 -962 -715)	173
5366-15	192	5DIW52BKD	394	6113701EN3(-962 -778)	504	65087(-848 -962 -715)	173
5366EN3-15	192	5DIW52PBSD	394	6114501(-962 -710 -112)	490	65087EN3(-848 -962 -715)	173
5367PC-15	192	5DIW52RBD	394	6114501EN7(-962 -710 -112)	490	6514401(-848 -962 -710)	175
5367PCEN3-15	192	5DIW52WHD	394	6115201(-05 -962 -710)	486	6514401EN3(-848 -962 -710)	175
5720593S-15	194	5LD52BS	387	6115201EN3(-05 -962 -710)	486	6514402(-848 -962)	174
5727093S-15	197	5LD52BSD	385	61160(-05 -962 -112)	470	6514402EN3(-848 -962)	174
591320S-15	196	5LD52BSF	386	61160EN3(-05 -962 -112)	470	6514501-962	490
591321S-15	196	5LD52BZ	387	61170(-112 -710 -962)	472	6514501EN7-962	490
59132LE-15	195	5LD52BZD	385	61170EN7(-112 -710 -962)	472	6515201(-05 -962 -710)	486
591360S-15	196	5LD52BZF	386	6120201(-962 -710)	477	6515201EN3(-05 -962 -710)	486
591361S-15	196	5LD52MBK	387	6120201EN3(-962 -710)	477	65160(-05 -962 -112)	470
59136LE-15	195	5LD52MBKD	385	6121601(-962 -710 -112)	512	65160EN3(-05 -962 -112)	470
5920593S-15	194	5LD52MBKF	386	6121601EN3(-962 -710 -112)	512	6516501(-05 -962 -710 -112 -848)	526
5927093S-15	197	5LD52RZW	387	6124501(-962 -710)	516	6516501EN3(-05 -962 -710 -112 -848)	526
59270LE-15	195	5LD52RZWD	385	6124501EN3(-962 -710)	516	6517401(-962 -710 -846)	170
59271LE-15	195	5LD52RZWF	386	6124601-962	502	6517401EN3(-962 -710 -846)	170
5COM52AGP	383	5LDDC52BSD	384	6124601(-848 -962 -112)	466	6528803(-962 -710 -112)	494, 498, 512
5COM52AGPD-V1	382	5LDDC52BZD	384	6124601EN3-962	502	6528803EN3(-962 -710 -112)	494, 498, 512
5COM52BS	383	5LDDC52MBKD	384	6124601EN3(-848 -962 -112)	466	6536901(-710 -962)	157
5COM52BSD-V1	382	5LDDC52RZWD	384	6124901-846	165	6536901EN7(-710 -962)	157
5COM52MBK	383	5LDO44BZ	393	6128801(-962 -710 -112)	494	6537303(-962 -710)	520
5COM52MBKD-V1	382	5LDO44MBK	393	6128801EN3(-962 -710 -112)	494	6537303EN3(-962 -710)	520
5COM52RB	383	5LDO44RZW	393	6130701(-962 -710 -112)	498	6613304-846	131
5COM52RBD-V1	382	5LDO52BZD	392	6130701EN3(-962 -710 -112)	498	6613304EN3-846	131
5COM52RZW	383	5LDO52MBKD	392	6137301(-962 -710)	520	6614501-962	490
5COM52RZWD-V1	382	5LDO52RZWD	392	6137301EN3(-962 -710)	520	6614504(-962 -710 -112)	117, 488

6614504EN7(-962 -710 -112)	117, 488	7524902-846EN-846	191	78027EN7(-57 -12)	326	8238601EN7(-71 -12)	291
6615008(-848 -05 -710 -112)	124	7537302(-962 -710)	520	78131-12	297	8238651(-71 -12)	289
6615008EN(-848 -05 -710 -112)	124	7537302EN3(-962 -710)	520	78131EN7-12	297	8238651EN3(-71 -12)	289
6615203(-05 -962 -710)	486	7541502-112	190	78136-12	287, 307, 315	8238701-71	291
6615203EN3(-05 -962 -710)	486	7541502EN7-112	190	78136EN7-12	315	8238701EN7(-71 -12)	291
66160(-05 -962 -112)	118, 470	75434(-15 -05 -962 -848 -710 -112)	188	7821402EN7(-71 -12)	343	8238751(-71 -12)	289
66160EN3(-05 -962 -112)	118, 470	75434EN3(-15 -05 -962 -848 -710 -112)	188	7847902-12	275	8238751EN3(-71 -12)	289
6616503(-962 -710 -112 -848)	526	75435(-15 -05 -962 -848 -710 -112)	188	7847902EN3-12	275	8239(-02 -965 -71 -12)	301
6616503(-962 -710)	476	7543502-962	193	7890902(-71 -12)	269	8239EN(-02 -965 -71 -12)	301
6616503EN3(-962 -710 -112 -848)	526	7543502EN3-962	193	7890902EN3(-71 -12)	269	8247901(-71 -12)	275
6616503EN3(-962 -710)	476	7543503-962	193	79039(-57 -12)	327	8247901EN3(-71 -12)	275
6624503-962	508, 516	7543503EN3-962	193	7903997S(-57 -12)	327	8250701-71	321
6624503EN3-962	508	75435EN3(-15 -05 -962 -848 -710 -112)	188	79039EN3(-57 -12)	327	8250701EN3(-71)	321
6624503EN3(-962)	516	75436(-15 -05 -962 -848 -710 -112)	188	79131-12	296	8252-68	345
6624603(-848 -962 -112)	466	75436EN3(-15 -05 -962 -848 -710 -112)	188	79131EN3-12	296	8252701(-12)	273
6624603EN3(-848 -962 -112)	466	75444EN3-710	188	79136-12	286, 305, 314	8252701EN3(-12)	273
6628003(-962 -710)	148	7567(-15 -32)	343	79136EN3-12	286, 305, 314	82529(-746 -12)	293
6628003EN3(-962 -710)	148	7567EN3(-15 -32)	343	7950893S(-753 -71)	187	82529EN3(-746 -12)	293
6634506(-848 -962 -872 -710)	123	7569(-15 -32)	343	8037(-02 -965 -71 -12)	300	8252EN3-68	345
6634506EN(-848 -962 -872 -710)	123	7569093S(-112 -848 -962)	185	8037EN7(-02 -965 -71 -12)	300	8254-68	345
6634507(-848 -962 -872 -710)	122	7569EN3(-15 -32)	343	8038(-02 -965 -71 -12)	300	8254EN3-68	345
6634507EN(-848 -962 -872 -710)	122	7643593S-962	193	8038EN7(02 -965 -71 -12)	300	8255-12	344
6637304(-962 -710)	121, 519	7650893S(-753 -71)	187	8039(-02 -965 -71 -12)	300	8255EN7-12	344
6637304EN3(-962 -710)	121, 519	7713702-962	504	8039EN(-02 -965 -71 -12)	300	8257(-965 -71 -12)	299
6639003-962	524	7713702EN3-962	504	8040(-02 -965 -71 -12)	300	82570-71	298
6639003EN3-962	524	7714502(-962 -710 -112)	490	8040EN(-02 -965 -71 -12)	300	82570EN3-71	298
6639103-962	502	7714502EN7(-962 -710 -112)	490	8067(-02 -965 -71 -12)	300	8257EN7(-965 -71 -12)	299
6639103EN3-962	502	7715202(-05 -962 -710)	486	8067EN7(-02 -965 -71 -12)	300	8259-46	280
6641504-112	127	7715202EN3(-05 -962 -710)	486	8101(-71 -12)	351	8259EN-46	280
6641504EN7-112	127	77160(-05 -962 -112)	470	8102(-15 -12)	351	8262(-46 -44)	279
69025-12	305	77160EN3(-05 -962 -112)	470	8112-12	351	8262EN(-46 -44)	279
69025EN3-12	305	7716502(-962 -710 -112 -05 -848)	527	8114-12	351	8269(-98 -44 -12)	335
69029(-57 -12)	327	7716502(-962 -710)	477	8120-12	351	8269EN3(-98 -44 -12)	335
6902997S(-57 -12)	327	7716502EN3(-962 -710 -112 -05 -848)	527	82027(-57 -12)	326	8275-32	344
69029EN3(-57 -12)	327	7716502EN3(-962 -710)	477	82027EN7(-57 -12)	326	8275EN7-32	344
69131-12	296	7716503(-962 -710 -112 -848)	527	82029(-746 -12)	295	8290901(-71 -12)	269
69131EN3-12	296	7716503EN3(-962 -710 -112 -848)	527	82029EN7(-746 -12)	295	8290901EN3(-71 -12)	269
7*POST-BK	350	7724503-962	508, 516	82065-12	344	82938(-71 -12)	287
7*POST-BRAL	350	7724503EN3-962	508, 516	82065EN3-12	344	82938EN7(-71 -12)	287
7*POST-CB	350	7724602(-848 -962 -112)	466	8209(-02 -12)	303	82941(-71 -12)	286
7*POST-ES	350	7724602EN3(-848 -962 -112)	466	8209EN7(-02 -12)	303	82941EN3(-71 -12)	286
7*POST-GBZ	350	7724903-846	191	82131-12	297	83046-714	341
7*POST-HTBZ	350	7724903EN-846	191	82131EN7-12	297	83046-714/T	341
7*POST-ORB	350	7728002(-962 -710)	149	821402(-71 -12)	343	83046EN3-714	341
7*POST-SBR	350	7728002EN3(-962 -710)	149	82200-12	315	8304701-714	341
7*POST-WAL	350	7728803(-962 -710 -112)	494, 498, 512	82200EN-12	315	8304701-714/T	341
736301EN3(-71 -12)	276	7728803EN3(-962 -710 -112)	494, 498, 512	82202-12	315	8304701EN3-714	341
7443593S-962	193	7737302(-962 -710)	520	82202EN7-12	315	8304801-714	341
7449403(-15 -962 -848)	179	7737302EN3(-962 -710)	520	82240-780	282	8304801-714/T	341
7449405(-15 -962 -848)	178	7737303(-962 -710)	520	82240EN3-780	282	8304801EN3-714	341
7449603(-05 -962 -848 -112)	181	7737303EN3(-962 -710)	520	8229(-965 -71 -12)	301	83057(-15 -12)	339
7449605(-05 -962 -848 -112)	180	7739002(-962 -710)	524	8229EN(-965 -71 -12)	301	83057EN3(-15 -12)	339
7513702-962	504	7739002EN3(-962 -710)	524	8231-12	307	8335(-15 -12)	338
7513702EN3-962	504	7739102-962	502	8231EN-12	307	8335EN3(-15 -12)	338
7514503(-962 -710)	490	7739102EN3-962	502	8236301(-71 -12)	276	8338701(-71 -12)	290
7514503EN(-962 -710)	490	7750893S(-753 -71)	187	8236301EN3(-71 -12)	276	8338701EN7(-71, 12)	290
7524902-846	191	78027(-57 -12)	326	8238601(-71 -12)	291	8338751(-71 -12)	288

INDEX

833875IEN3(-71 -12)	288	8507EN7(-02 -12)	302	859300IEN3(-15 -965 -71 -12)	325	8753EN3(-15 -34)	340
84029EN7(-746 -12)	294	850890I(-12 -71)	271	8593EN7(-15 -965 -71 -12)	325	8765(-15 -12)	342
84030(-746 -12)	294	850890IEN7(-12 -71)	271	860890I(-12 -71)	271	8765EN7(-15 -32)	342
84030EN7(-746 -12)	294	8509(-02 -12)	302	860890IEN7(-12 -71)	271	8788(-15 -155 -10 -12)	324
84031(-746 -12)	294	8509EN7(02 -12)	302	861830I(-04 -71 -12)	263	879090I(-71 -12)	267
84031EN7(-746 -12)	294	8510(-02 -12)	302	861830IEN3(-04 -71 -12)	263	879090ID-12	267
84032(-746 -12)	294	8510EN7(-02 -12)	302	861930I(-71 -12)	277	879090IDEN3(-71 -12)	267
84032EN7(-746 -12)	294	851830I(-04 -71 -12)	263	861930IEN3(-71 -12)	277	879090IEN3(-71 -12)	267
84157D-71	299	851830IEN3(-04 -71 -12)	263	862070I(-71-12 -04)	263	88025(-57 -12)	326
84157DEN3-71	299	851930I(-71 -12)	277	862070IEN3(-71 -12 -04)	263	88025EN7(-57 -12)	326
84158D(-71 -12)	299	851930IEN3(-71 -12)	277	863630I(-71 -12)	276	88027(-57 -12)	326
84158DEN3(-71 -12)	299	85200-12	315	863630IEN3(-71 -12)	276	88027EN7(-57 -12)	326
843850I-12	333	85200EN7-12	315	863850I-12	333	880890I(-12 -71)	271
843850IEN3-12	333	852070I(-04 -71 -12)	263	863850IEN3-12	333	880890IEN7(-12 -71)	271
843870I(-71 -12)	290	852070IEN3(-04 -71 -12)	263	863860I(-71 -12)	265	8813I-12	297
843870IEN7(-71, -12)	290	853630I(-71 -12)	276	863860IEN3(-71 -12)	265	8813IEN7-12	297
843875I(-71 -12)	288	853630IEN3(-71 -12)	276	863870I(-71 -12)	291	88132-12	297
843875IEN3(-71 -12)	288	853850I(-04 -12)	333	863870IEN7(-71 -12)	291	88132EN7-12	297
84529(-746 -12)	292	853850IEN3(-04 -12)	333	863875I(-71 -12)	289	88200-12	315
84529EN3(-746 -12)	292	853860I(-71 -12)	265	863875IEN3(-71 -12)	289	88200EN7-12	315
84530(-746 -12)	292	853860IEN3(-71 -12)	265	8642(-15 -12)	349	88201-12	315
84530EN3(-746 -12)	292	853870I(-71 -12)	291	864770I(-04 -44 -12)	334	88201EN-12	315
84531(-746 -12)	292	853870IEN7(-71 -12)	291	864770I(-04 -44)/T	334	88203-12	315
84531EN3(-746 -12)	292	853875I(-71 -12)	289	864770IEN3(-04 -44 -12)	334	88203EN7-12	315
84532(-746 -12)	292	853875IEN3(-71 -12)	289	865070I-71	321	8822-12	306
84532EN3(-746 -12)	292	854770I(-04 -44 -12)	334	865070IEN3-71	321	8822EN7-12	306
8456(-965 -71 -12)	299	854770I(-04 -44)/T	334	865270I(-71 -12)	273	8824-12	306
84560-71	298	854770IEN3(-04 -44 -12)	334	865270IEN3(-71 -12)	273	88240(-780 -12)	283
84560EN3-71	298	854790I(-71 -12)	274	869090I(-71 -12)	268	88240D-780	283
8456EN7-965-71-12	299	854790IDEN3(-71 -12)	274	869090ID(-71 -12)	268	88240DEN3-780	283
8457(-965 -71 -12)	299	854790IEN3(-71 -12)	274	869090IDEN3(-71 -12)	268	88240EN3(-780 -12)	283
84570-71	298	8550-12	340	869090IEN3(-71 -12)	268	8824I(-780)	283
84570EN3-71	298	855000I-12	340	870890I(-12 -71)	271	8824IEN3(-780 -12)	283
8457EN7-965-71-12	299	855000IEN3-12	340	870890IEN7(-12 -71)	271	88242(-780 -12)	282
8458(-965 -71 -12)	299	855070I-71	321	871830I(-04 -71 -12)	263	88242EN3(-780 -12)	282
84580-71	298	855070IEN3-71	321	871830IEN3(-04 -71 -12)	263	88243(-780 -12)	282
84580EN3-71	298	8550EN7-12	340	871930I(-71 -12)	277	88243EN3(-780 -12)	282
8458EN7-965-71-12	299	855270I(-71 -12)	273	871930IEN3(-71 -12)	277	88244(-780 -12)	283
8459-46	280	855270IEN3(-71 -12)	273	8720(-15 -32)	342	88244EN3(-780 -12)	283
8459EN-46	280	856070I(-15 -71 -12)	348	872070I(-04 -71)	263	8824EN7-12	306
8460-46	280	856070IPM(-15 -71 -12)	348	872070IEN3(-04 -71)	263	8825-12	306
8460EN-46	280	856070IPMEN3(-15 -71 -12)	348	8720EN7(-15 -32)	342	8825EN7-12	306
8461-46	280	8560702(-15 -71 -12)	349	873630I(-71 -12)	276	883870I(-71 -12)	291
8461EN-46	280	8560702PM(-15 -71 -12)	349	8738703(-71 -12)	290	883870IEN7(-71 -12)	291
8462(-44 -46)	279	8560702PMEN3(-15 -71 -12)	349	8738703EN(-71 -12)	290	883875I(-71 -12)	289
8462D-44	278	8588(-15 -155 -10 -12)	324	873875I(-71 -12)	288	883875IEN3(-71 -12)	289
8462DEN3-44	278	8588EN7)-15 -155 -10 -12)	324	873875IEN3(-71 -12)	288	884790I(-71 -12)	274
8462EN7(-44 -46)	279	859090I(-71 -12)	268	874790I(-71 -12)	274	884790IDEN3(-71 -12)	274
8463(-44 -46)	279	859090ID(-71 -12)	268	874790IDEN3(-71 -12)	274	884790IEN3(-71 -12)	274
8463D-44	278	859090IDEN3(-71 -12)	268	874790IEN3(-71 -12)	274	8869(-98 -44 -12)	335
8463DEN3-44	278	859090IEN3(-71 -12)	268	8750(-15 -12)	340	8869EN3(-98 -44 -12)	335
8463EN(-44 -46)	279	8592(-15 -965 -71 -12)	325	875070I-71	321	8870(-98 -44 -12)	335
84670-71	298	859200I(-15 -965 -71 -12)	325	875070IEN3-71	321	8870EN3(-98 -44 -12)	335
84670EN3-71	298	859200IEN3(-15 -965 -71 -12)	325	8750EN7(-15 -12)	340	8871(-98 -44 -12)	335
8468(-965 -71 -12)	299	8592EN7(-15 -965 -71 -12)	325	875270I(-71 -12)	273	8871EN3(-98 -44 -12)	335
8468EN(-965 -71 -12)	299	8593(-15 -965 -71 -12)	325	875270IEN3(-71 -12)	273	88880-51	330
8507(-02 -12)	302	859300I(-15 -965 -71 -12)	325	8753(-15 -34)	340	88880EN3-51	330

88881-51	330	89822-12	304	94458-1	435	984024S(-12 -15)	420
88881EN3-51	330	89822EN3-12	304	94458-12	439, 532	984072S(-12 -15)	420
88882-51	330	89824-12	304	94460-12	435, 439, 532	984099S(-12 -15)	421
88882EN3-51	330	89824EN3-12	304	94461-12	532	984100S (-15 -962 -12)	420
8890901(-71 -12)	267	89825-12	304	94462-12	435, 439, 532	984100S(-15 -962 -12)	418
8890901D(-71 -12)	267	89825EN3-12	304	94481S(-15 -849 -171)	259	984101S(-12 -15)	421, 438
8890901DEN3(-71 -12)	267	8988EN3(-15 -155 -10 -12)	324	94483S(-849 -171)	259	984102S(-12 -15)	421
8890901EN3(-71 -12)	267	89936(-71 -12)	285	94485S(-15 -849 -171)	259	984124S(-12 -15)	420
88936(-71 -12)	285	89936EN3(-71 -12)	285	9450	427, 435	984172S(-12 -15)	420
88936EN7(-71 -12)	285	89937(-71 -12)	284	9459(-15 -12)	435	984201S(-12 -15)	421, 438
88937(-71 -12)	284	89937EN3(-71 -12)	284	9469(-15 -12)	435	984218S-15	421, 438
88937EN7(-71 -12)	284	89940(-71 -12)	285	9470(-15 -12)	435	984230S-15	421, 438
88940(-71 -12)	285	89940EN3(-71 -12)	285	9471(-15 -12)	435	9862	427, 435
88940EN7(-71 -12)	285	89941(-71 -12)	284	9481-15	435	98670-15	427
88941(-71 -12)	284	89941EN3(-71 -12)	284	9488-12	435	98672-97	427
88941EN7(-71 -12)	284	900004-15	424, 426	95220S-15	415	98700S-986	430, 434
89025-12	305	900005-15	424, 426	95221S-15	415	98701S-986	430, 434
89025EN3-12	305	900006-15	424, 426	95222S-15	415	98702S-986	430, 434
89029(-57 -12)	327	900007-15	424, 426	95223S-15	415	98703S-986	430, 434
8902997S(-57 -12)	327	9027-15	415	95230S-15	415	98743S-12	427
89029EN3(-57 -12)	327	9032-12	539	95231S-15	415	98743S-12	437, 532
89031(-57 -12)	327	9032-24	539	95236S-15	415	98745S-12	427, 437, 532
8903197S-12	327	905000-15	426	95237S-15	415	98746S-12	427, 437, 532
89031EN3(-57 -12)	327	905001-15	426	9600(-71 -12)	347	98747S-12	427, 437, 532
89062-46	278	905002-15	426	96091S(-15 -71 -12)	347	C	
89062EN3-46	278	905003-15	426	96116S-32	535	CK250	396
8909PEN3-12	340	905004-15	426	96116S-33	535	CK300	396
89101-12	314	905005-15	426	96116S(-32 -33)	431, 434	CT100	396
89101EN3-12	314	905006-15	426	96118S-32	434, 535	CT150	396
89102-12	314	905007-15	426	96118S-33	535	D	
89102EN3-12	314	905040-15	426	96118S(-32 -33)	431	DJC1005(BS SB MBK)	91
89103-12	314	905045-32	427	9647	347	DJC1016(BS SB MBK)	91
89103EN3-12	314	90610-68	347	96622S-12	435, 439, 532	DJC1024(SB MBK)	93
89104-12	314	90611-68	347	96623S-12	532	DJC1035(SB MBK)	93
89104EN3-12	314	90612-68	347	96624S-12	435, 439, 532	DJC1048(BS SB MBK)	87
89129(-57 -12)	327	90613-68	347	97118-32	535	DJC1058(BS SB MBK)	87
89129EN3(-57 -12)	327	90614-68	347	97118-33	535	DJC1086(BS SB MBK)	89
89131-12	296	90615-68	347	97118(-32 -33)	432, 434	DJC1099(BS SB MBK)	88
89131EN3-12	296	90616-68	347	97119-32	535	DJC1104(SB MBK)	97
89132-12	296	90617-68	347	97119-33	535	DJC1114(SB MBK)	97
89132EN3-12	296	90618-68	347	97119(-32 -33)	432, 434	DJC1126(SB MBK)	97
89202-12	314	90619-68	347	9728	433, 535	DJF1002SB	184
89202EN3-12	314	90621-68	347	9731	433, 535	DJF1011(MWT N V Y MBK)	189
89231-12	296	93401S(-15 -849 -171)	258	9732	433, 535	DJP1002SB	147
89231EN3-12	296	93403S(-15 -849 -171)	258	97500S	535	DJP1011SB	147
89273-46	278	93405S(-15 -849 -171)	258	97512S	535	DJP1021(MWT N V Y MBK)	154
89273EN3-46	278	93481S(-15 -849 -171)	258	97531S	535	DJP1031(MWT N V Y MBK)	154
8938701(-71 -12)	290	93483S(-15 -849 -171)	258	97532S	535	DJP1041(MWT N V Y MBK)	154
8938701EN7(-71, -12)	290	93485S(-15 -849 -171)	258	97541S	535	DJP1052SB	146
8938751(-71 -12)	288	9380(-15 -12)	435	97542S	535	DJP1063SB	146
8938751EN3(-71 -12)	288	9428(-15 -12)	433, 434	9774	535	DJP1074SB	146
89805(-15 -12)	338	9435(-15 -12)	435	9777	535	DJP1091(BS SB MBK)	152
89805EN3(-15 -12)	338	9438(-15 -12)	435	9830(-15 -12)	431, 432, 434	DJP1101(BS SB MBK)	153
89806(-15 -12)	338	94401S(-15 -849 -171)	259	984003S(-12 -15)	420	DJP1111(SBMWT SBMBK)	155
89806EN3(-15 -12)	338	94403S(-849 -171)	259	984006S(-12 -15)	420	DJT1011S (SB1 MBK1)	75
89807(-15 -12)	339	94405S(-15 -849 -171)	259	984012S(-12 -15)	420	DJT1041(SB1 MBK1)	73
89807EN3(-15 -12)	339	9443-12	435	984018S(-12 -15)	420	DJT1051(GW1 GNV1 GBK1)	79

INDEX

DJT1061(GW1 GNV1 GBK1)	83	DR24BS	401	DR72BBS	401	FM313(CH BS ORB)	186
DJT1071(GW1 GNV1 GBK1)	81	DR24BZ	401	DR72BK	401	FM313EN3/(CH BS ORB)	186
DJT1081(SB1 MBK1)	77	DR24HAB	401	DR72BNZ	401	L	
DJV1001(CH BS SB MBK)	210	DR24MBK	401	DR72BS	401	LTB10C35027CB	535
DJV1002(CH BS SB MBK)	210	DR24OZ	401	DR72BZ	401	M	
DJV1003(CH BS SB MBK)	210	DR24PN	401	DR72HAB	401	MC224BS-V1	403
DJV1004(CH BS SB MBK)	210	DR24RB	401	DR72MBK	401	MC224RB-V1	403
DJV1011(BS SB MBK)	213	DR24RZW	401	DR72OZ	401	MC224RZW-V1	403
DJV1012(BS SB MBK)	213	DR24SB	401	DR72PN	401	MC242	403
DJV1013(BS SB MBK)	213	DR24SN	401	DR72RB	401	MC247BS	403
DJV1014(BS SB MBK)	213	DR24WH	401	DR72RZW	401	MC247RB	403
DJV1021(CH BS SB MBK)	212	DR36AGP	401	DR72SB	401	MC247RZW	403
DJV1022(CH BS SB MBK)	212	DR36BBS	401	DR72SN	401	MC260BS	403
DJV1023(CH BS SB MBK)	212	DR36BK	401	DR72WH	401	MC260MBK	403
DJV1024(CH BS SB MBK)	212	DR36BNZ	401	DRC12MBK	401	MC260PN	403
DJV1031(CH BS SB MBK)	211	DR36BS	401	DRC12RZW	401	MC260RZW	403
DJV1032(CH BS SB MBK)	211	DR36BZ	401	DRC18MBK	401	MC261AGP	403
DJV1033(CH BS SB MBK)	211	DR36HAB	401	DRC18RZW	401	MC261BS	403
DJV1034(CH BS SB MBK)	211	DR36MBK	401	DRC24MBK	401	MC261OZ	403
DJW1001(BS SB MBK)	200	DR36OZ	401	DRC24RZW	401	MC261RZW	403
DJW1011(SB MBK)	200	DR36PN	401	DRC36MBK	401	MC264AGP	403
DJW1022(BS SB MBK)	201	DR36RB	401	DRC36RZW	401	MC264BK	403
DJW1051(BS SB MBK)	201	DR36RZW	401	DRC48MBK	401	MC264RZW	403
DR12AGP	401	DR36SB	401	DRC48RZW	401	MC265AGP	403
DR12BBS	401	DR36SN	401	DRC60MBK	401	MC265BK	403
DR12BK	401	DR36WH	401	DRC60RZW	401	MC265BS	403
DR12BNZ	401	DR48AGP	401	DRC72MBK	401	MC265RZW	403
DR12BS	401	DR48BBS	401	DRC72RZW	401	MC266BK	403
DR12BZ	401	DR48BK	401	E		MC266OZ	403
DR12HAB	401	DR48BNZ	401	ESSWC-10	398	MC266RB	403
DR12MBK	401	DR48BS	401	ESSWC-11	398	MC266RZW	403
DR12OZ	401	DR48BZ	401	ESSWC-3-WH	398	MC360AGP	402
DR12PN	401	DR48HAB	401	ESSWC-4-WH	398	MC360BK	402
DR12RB	401	DR48MBK	401	ESSWC-5-WH	398	MC360BS	402
DR12RZW	401	DR48OZ	401	ESSWC-6-WH	398	MC360RB	402
DR12SB	401	DR48PN	401	ESWC-1	398	MC360RZW	402
DR12SN	401	DR48RB	401	F		MC362AGP	402
DR12WH	401	DR48RZW	401	F1902/6MBZ	111	MC362BS	402
DR18AGP	401	DR48SB	401	F1938/8+4MBZ	111	MC362MBK	402
DR18BBS	401	DR48SN	401	F2110/8+4+4MBZ	110	MC362RZW	402
DR18BK	401	DR48WH	401	F2303/8MBZ	111	MC93AGP	400
DR18BNZ	401	DR60AGP	401	F2478/6OBZ	109	MC93BBS	400
DR18BS	401	DR60BBS	401	F2629/8+4AF/BS	112	MC93BK	400
DR18BZ	401	DR60BK	401	F2630/8AF/BS	130	MC93BS	400
DR18HAB	401	DR60BNZ	401	F2985/6SN/CH	107	MC93BZ	400
DR18MBK	401	DR60BS	401	F2986/8SN/CH	119	MC93CH	400
DR18OZ	401	DR60BZ	401	F2987/9SN/CH	107	MC93KOA	400
DR18PN	401	DR60HAB	401	F3169/5DWI	105	MC93MBK	400
DR18RB	401	DR60MBK	401	F3280/8ADB	108	MC93OZ	400
DR18RZW	401	DR60OZ	401	F3281/12ADB	108	MC93PN	400
DR18SB	401	DR60PN	401	F3290/12AI	103	MC93RB	400
DR18SN	401	DR60RB	401	F3291/8AI	103	MC93RZW	400
DR18WH	401	DR60RZW	401	F3292/8AI	128	MC93SN	400
DR24AGP	401	DR60SB	401	F3340/5AI/ADB	104	MC93WGR	400
DR24BBS	401	DR60SN	401	F3341/8AI/ADB	104	MC93WH	400
DR24BK	401	DR60WH	401	FM312(CH BS ORB)	186	MC95AGP	400
DR24BNZ	401	DR72AGP	401	FM312EN3/(CH BS ORB)	186	MC95BBS	400

MC95BK	400	OL5421BK	312	P1240DAB	163	POSTBASE-PBS	353
MC95BNZ	400	OL5422BK	312	P1242AF	163	POSTBASE-PDB	353
MC95BS	400	OL5423BK	312	P1253 (BK BS DBZ)	176	POSTBASE-PTBZ	353
MC95BZ	400	OL5424BK	312	P1261ORB	162	POSTBASE-SBL	353
MC95CH	400	OL5427BK(BK GBZ)	313	P1282DAB/MB	167	S	
MC95GRY	400	OL5428BK	313	P1283DAB/MB	167	S39188	535
MC95KOA	400	OL5431BK	313	P1334SN/CH	161	SF292AF/BS	190
MC95OZ	400	OL5432BK	313	P1354(ORB SN)	166	V	
MC95PN	400	OL5433BK	313	P1355(ORB SN)	166	VS23301SN/CH	239
MC95RB	400	OL5900(CB BK)	281	P1357(ORB SN)	166	VS23302SN/CH	239
MC95RZW	400	OL5900EN7(CB BK)	281	P1394DFW/DWZ	158	VS23303SN/CH	239
MC95SN	400	OL5901(CB, BK)	281	P1395DFW/DWZ	158	VS2461BBS	247
MC95TI	400	OL5901EN/(CB BK)	281	P1449 (CH DWI)	159	VS2463BBS	247
MC95WH	400	OL5902(CB BK)	281	P1459 (CH DWI)	159	VS2471MBK	221
MCRC1	396	OL5902EN/(CB BK)	281	P1484(CH SN ORB)	160	VS2472MBK	221
MCRCIT	396	OL5904(CB, BK)	281	PIER MT-ASTB	352	VS2473MBK	221
MCRC3	396	OL5904EN/(CB BK)	281	PIER MT-BK	352	W	
MCRC3W	396	OL5907(CB BK)	281	PIER MT-BRAL	352	WB1451(BS ORB)	204
MCSMRC	398	OL5907EN/(CB BK)	281	PIER MT-CB	352	WB1560AF/BS	204
MPC03ORB(ORB PN SN)	177	OL5911(CB BK)	281	PIER MT-ES	352	WB1703(DAB PN)	219
MPC07ORBORB	177	OL5911EN/(CB BK)	281	PIER MT-GBZ	352	WB1704(DAB PN)	219
MR1107AF	252	OL7400ASTB	329	PIER MT-HTBZ	352	WB1828SGM	331
MR119ORB	253	OL7402ASTB	329	PIER MT-ORB	352	WB1846ANBZ	205
MR1152	252	OL7600ES	319	PIER MT-SBR	352	WB1850(CH DWI)	203
MR1154	252	OL7601ES	319	PIER MT-WAL	352	WB1920ADB	204
MR1300(BBS MBK PN)	253	OL7602ES	319	PIERMOUNT-ANBZ	352	WB1940AI	205
MR1301(BBS MBK PN)	253	OL7604ES	319	PIERMOUNT-CO	352		
MR1303(BBS MBK PN)	253	OL7613ES	319	PIERMOUNT-DWZ	352		
O		OL7621ES	318	PIERMOUNT-HTCP	352		
OL12900TXB	323	OL7622ES	318	PIERMOUNT-NCP	352		
OL12901TXB	323	OL7623ES	318	PIERMOUNT-PBS	352		
OL12902TXB	323	OL7627ES	318	PIERMOUNT-PDB	352		
OL14372CO	331	OL7633ES	318	PIERMOUNT-PTBZ	352		
OL15200ANBZ	316	OL8600(RSZ TRD TXB)	337	PIERMOUNT-SBL	352		
OL15201ANBZ	316	OL8600RSZ-L1	337	PIERMOUNT-TXB	352		
OL15202ANBZ	316	OL8600RSZ/T	337	PIERMOUNT-WCT	352		
OL15203ANBZ	316	OL8600TRD-L1	337	POST-ANBZ	350		
OL15204ANBZ	316	OL8600TRD/T	337	POST-CO	350		
OL15207ANBZ	317	OL8600TXB-L1	337	POST-DWZ	350		
OL15209ANBZ	317	OL8600TXB/T	337	POST-HTCP	350		
OL2200BB	322	OL8601(RSZ TRD TXB)	337	POST-NCP	350		
OL2202BB	322	OL8601RSZ-L1	337	POST-PBS	350		
OL2601ORB	328	OL8601RSZ/T	337	POST-PDB	350		
OL2602ORB	328	OL8601TRD-L1	337	POST-PTBZ	350		
OL5400(BK GBZ)	309	OL8601TRD/T	337	POST-SBL	350		
OL5401(BK GBZ)	309	OL8601TXB-L1	337	POST-TXB	350		
OL5402(BK GBZ)	309	OL8601TXD/T	337	POST-WCT	350		
OL5403(BK GBZ)	309	OL8701ORB	331	POSTBASE ASTB	353		
OL5404(BK GBZ)	309	OL9004(RSZ TRD TXB)	337	POSTBASE BK	353		
OL5405(BK GBZ)	309	OL9004RSZ-L1	337	POSTBASE ES	353		
OL5407(BK GBZ)	311	OL9004RSZ/T	337	POSTBASE GBZ	353		
OL5408(BK GBZ)	311	OL9004TRD-L1	337	POSTBASE HTBZ	353		
OL5411(BK GBZ)	310	OL9004TRD/T	337	POSTBASE ORB	353		
OL5412(BK GBZ)	310	OL9004TXB-L1	337	POSTBASE-ANBZ	353		
OL5413(BK GBZ)	311	OL9004TXB/T	337	POSTBASE-CO	353		
OL5414(BK GBZ)	310	P		POSTBASE-DWZ	353		
OL5420BK	312	PI234RI	162	POSTBASE-NCP	353		

FAMILY INDEX

TABLE		FLUSH & SEMI-FLUSH MOUNT		LED STEP AND HALL LIGHTING		JOVIE 58 LED	356
BINX	76	BOWAN	194	LED STEP/HALL LIGHTING	256	JOVIE 58	357
BUCKLEY	78	CLIP CEILING	193			JOVIE 52 LED	358
FERNWOOD	82	CORTES	184	OUTDOOR		JOVIE 52	369
MORESBY	80	DROP LENS	196	ADDRESS LIGHTS	346	JOVIE 44 LED	361
PENDER	72	ETHAN	190	ALBAN	262	JOVIE 44	362
PORTEAU	74	HYDE	189	ALUMINUM POSTS	350	JOVIE OUTDOOR 58 LED	390
		KOLMAR	197	BAKERSVILLE	284	JOVIE OUTDOOR 58	391
CHANDELIERS		LINEAR FLUSH MOUNT	195	BAYSIDE	338	LINDEN DC 52 LED	384
ALTURAS	98	MAHONE	187	BRENTWOOD	304	LINDEN 52 LED	385
ANSLEY	102	MITTE	190	CALDER	320	LINDEN 52 LED 3	386
BURKE	90	NASH	188	CAPE MAY	282	LINDEN 52	387
CAPALINO	86	RHETT	185	CEILING FLUSH MOUNTS	343	LINDEN 48 LED	388
CELESTE	104	SOCORRO	191	CHATHAM	278	LINDEN 48	389
CHATEAU	110	SUNSET DRIVE	186	CHILDRESS	276	LINDEN OUTDOOR 52 LED	392
DRISCOLL	92	TOMKIN	192	CLASSICO	302	LINDEN OUTDOOR 44	393
EGMONT	88	WEBSTER	192	COTSWOLD LANE	308	LOWDEN 52 LED	371
ETHAN	112			CRITTENDEN	332	LOWDEN SMART 60 LED	370
HADDEN	96	WALL SCONCES		CROWELL	274	ORBIS 52 LED	372
JONAH	107	ANSLEY	205	DAKOTA	318	ORBIS 52 HUGGER LED	373
LORAS	105	BURKE	200	DARBY	331	SYRUS 52 LED	374
MARIELLE	108	CAPALINO	201	DIE-CAST ALUMINUM PIER MOUNTS	352	TITUS 54 HUGGER LED	368
PORTEAU	93	EDLA	206	DIE-CAST ALUMINUM POST BASES	353	TITUS 44 HUGGER LED	369
RAVENWOOD MANOR	106	EGMONT	201	EDDINGTON	277		
SOCORRO	113	ETHAN	204	EXTRUDED ALUMINUM POSTS	350	LIGHTING SYSTEMS	
TOWNER	94	LORAS	202	FLOOD LIGHTS	348	JANE LED TAPE	424
VALENTINA	109	MARIELLE	204	FREDRICKSBURG	334	HIGH OUTPUT LED MODULES	430
		MARLENA	205	HERRINGTON	296	LED DISK LIGHTS	416
LINEAR		METROPOLIS	207	HUNNINGTON	326	LED FESTOON	431
ANSLEY	128	MILA	204	JAMESTOWNE	298	SELF-CONTAINED FLUORESCENT	412
BELTON	116	NEARU	207	KENT	292	VIVID 120V LED	410
DUNNING	131	NEVA	207	LANCASTER	300	WEDGE BASE	433
ELMWOOD PARK	120	PORTEAU	200	LENEX	331	XENON FESTOON	432
ETHAN	130	RAVEL	207	LIGHTHOUSE	322		
JONAH	119	STEPPED GLASS	206	MARKET SQUARE	328	RECESSED	
MITTE	126	TOWNER	205	MARTINSVILLE	381	4" HOUSING 1115	453
MOFFET STREET	122			MEDFORD LAKES	330	4" HOUSING 1179	452
OSLO	118	VANITY & MIRRORS		MILLBROOKE	316	6" HOUSING 11018	457
PERRYTON	124	ABBOTT	246	MULLBERRY HILL	324	6" HOUSING 11019	456
RAVENWOOD MANOR	129	ADELAIDE	220	NEW CASTLE	324	6" HOUSING 11028QC	455
		ALTURAS	236	PAINTABLE OUTDOOR		6" HOUSING 1109	458
LANTERNS		BAYFIELD	242	WALL SCONCES	341	6" HOUSING 1128	454
DAWES	143	BELCARRA	213	POST LANTERNS	344	6" HOUSING 1128QC	454
LABETTE	140	BELTON	231	RANDHURST	331	TRAVERSE AUBREY WALL WASH	445
MITTE	138	BRAUNFELS	248	REDDING STATION	336	TRAVERSE DIRECT	449
MOFFET STREET	136	CANFIELD	225	RENVILLE	264	TRAVERSE FLEX	447
PERRYTON	134	CENTER STAGE	250	ROSCOE	323	TRAVERSE LOTUS	446
ROMEE	142	CROFTON	211	SEBRING	335	TRAVERSE LYTE	448
		DRISCOLL	226	SEVIER	288	TRAVERSE MIRAGE	444
HANGING SHADE		ELLIS HARPER	233	TOMEK	272	WAFER LYTE	450
CORTES	147	ELMWOOD PARK	224	TRAFALGAR	280		
NANCE	148	EMMONS	245	TYBEE	270	BUILDER SERIES	
THURLO	146	ETHAN	252	WALL LANTERNS	242	ALTURAS	464
		FRANPORT	240	WALL SCONCES	340	BELTON	490
PENDANTS		HANFORD	244	WHITAKER	329	CANFIELD	494
BELLECARRA	152	HETTINGER	234	WILBURN	266	ELLIS HARPER	506
BELLE	176	INFINITY	252	WYNFIELD	314	ELMWOOD PARK	520
CADENCE	167	JACKIE	253			EMMONS	524
DIVISION STREET	170	KEMAL	232	CEILING FANS		FRANPORT	508
DRISCOLL	156	KERRVILLE	230	CEILING FAN ACCESSORIES	336	GEARY	528
FREDRICKSBURG	171	KIT	253	COLONY 60 LED	380	HANFORD	516
HOBSON	166	MITTE	218	COLONY 60	381	HETTINGER	502
HYDE	154	OSLO	222	COLONY 52 LED	382	KEMAL	498
JONAH	161	PROSPECT PARK	239	COLONY 52	383	KERRVILLE	486
KEA	157	ROBIE	238	CRUISE OUTDOOR 52	395	OSLO	470
LORAS	159	SAYWARD	210	DISCUS CLASSIC 52 LED	378	ROBIE	512
MARINO	160	SEVILLE	228	DISCUS CLASSIC 44 LED	379	SEVILLE	476
MATRIMONIO	158	TOFFINO	212	DISCUS ORNATE 52 LED	376	WINDOM	482
MULTI-PORT CANOPIES	177	TOWNER	216	DISCUS OUTDOOR 52 LED	394		
PEMBERTON	155	URBAN RENEWAL	219	DISCUS SMART 52 LED	375		
PRATT STREET METAL	173	VANDEVENTER	249	ERA 52 LED	364		
PRATT STREET PRISMATIC	172	WINDOM	214	ERA 52 HUGGER LED	365		
SOCORRO	164			ERA 44 LED	366		
STONE STREET	174			ERA 44 HUGGER LED	367		
TOWNER	168						
URBAN RENEWAL	162						

VISUAL COMFORT & Co.

7400 Linder Avenue
Skokie, IL 60077

Phone: 800.969.3347

Fax: 866.490.7765

visualcomfort.com | @visualcomfort