

WAC LIGHTING®

CONTRACTOR SOLUTIONS

2026

TABLE OF CONTENTS

TAPE LIGHT	Page 2
BUTTON & PUCK	Page 22
TRACK	Page 30
RECESSED	Page 52
DECORATIVE	Page 76
OUTDOOR	Page 100
FANS	Page 134



TAPE LIGHT SYSTEM

TAPE LIGHT

Designed for precision and flexibility, tape lighting from WAC Lighting delivers continuous illumination for architectural details and hard to light spaces. Its low profile form allows it to conform to contours and tight conditions while maintaining consistent, high quality light for accent, task, and highlight applications.

Engineered for reliability and ease of integration, these solutions support a wide range of residential and light commercial needs.

CHANNELS

Our aluminum channels provide a refined architectural framework for integrating linear lighting into built environments. Suitable for recessed, surface, suspended, or wall mounted installations, they create clean, controlled lines of light that align with modern construction and finishes.

When paired with our LED systems, channels support continuous illumination solutions that balance performance, durability and visual precision.

INVISILED®

THE INVISIBLE TOOL OF MODERN LIGHTING DESIGN

ADDITIONAL ITEMS AVAILABLE ON OUR WEBSITE

DUET See more on page 6



- 100, 200, 300, 400, 600, 1000 lm/ft
- Color Temp: 1800K-4000K, 2700K-5000K
- From bedrooms and bathrooms to kitchens, living rooms and task-oriented spaces, DUET adapts to every setting

LITE+ See more on page 8



- 150 lm/ft
- Color Temp: 2200K, 2700K, 3000K, 3500K, 4500K
- Rated for storage areas, including closets and other spaces for long-term usage

DIM-TO-WARM



- 200, 300 lm/ft
- Color Temp: 1800K-3000K, 1800K-3500K
- Created for any mood—warm light for entertaining, cool white for tasks

CCT



- 100, 200, 300, 400, 600, 1000 lm/ft
- Color Temp: 2700K/3000K/3500K/4000K/5000K
- Best-in-class qualities make it perfect for applications like bright coves or task lighting in dry or damp locations

PRO+ See more on page 9



- 200 lm/ft
- Color Temp: 2200K, 2700K, 3000K, 3500K, 4500K
- An ideal dimmable system for task and accent lighting applications

PRO 2+ See more on page 10



- 300 lm/ft
- Color Temp: 2200K, 2700K, 3000K, 3500K, 4500K
- Perfectly suited for under-cabinet, cove and toe-kick applications across residential, hospitality and commercial environments

RGBWW



- White light: 156-308 lm/ft, RGB: 124 lm/ft
- Color Temp: 2700K/3000K/3500K/4000K/5000K
- Select from full visible color spectrum for a custom lighting effect

TUNABLE WHITE



- 234-328 lm/ft
- Color Temp: Adjustable 1800K-5000K
- Delivers precise color consistency and brightness throughout its length, ideal for cove lighting

PRO 3 See more on page 11



- Up to 475 lm/ft
- Color Temp: 2700K, 3000K, 3500K, 4500K
- Engineered for task and accent lighting, this tape folds to create custom patterns

GEMINI See more on page 14



- Up to 300 lm/ft
- Color Temp: 2700K/3000K/3500K/4000K
- Creates a seamless, continuous line of light for a clean architectural finish

OUTDOOR



OUTDOOR



OUTDOOR PRO+



OUTDOOR RGBWW



INVISIBLE DUET

TWO-WIRE SYSTEM FOR POWER AND CONTROL TAPE LIGHT



- Input:** 24VDC
- Max Lumens:** 1000 lm / ft
- Dimming:** TRIAC/ELV/0-10V
- CRI:** 90
- Rated Life:** 50,000 hours
- CCT Select Power Supply for manual CCT adjustment (choose between Option A: 1800K–4000K or Option B: 2700K–5000K)
- Uniform brightness with advanced Chip-on-Board LEDs
- Strong adhesive bonding with the 3M adhesive VHB
- May be cut and easily reconnected every 4 inches
- Closet Rated options (DU1, DU2, DU3)

CCT selectable output on the physical power supply switch

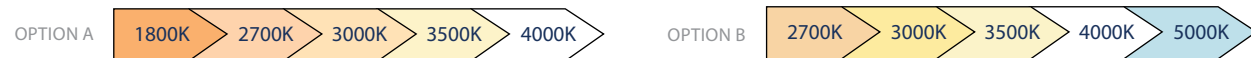

Model	Max Run	Power	Length (in feet)	Color Temp	Finish
T24-DU1	100+lm/ft	60'	1.2W/ft	01 05 10 20 60	White
T24-DU2	200+lm/ft	40'	2.3W/ft	01 05 10 20 40	
T24-DU3	300+lm/ft	30'	3.5W/ft	01 05 10 20 30	
T24-DU4	400+lm/ft	20'	4.7W/ft	01 05 10 20 N/A	
T24-DU6	600+lm/ft	15'	5.4W/ft	01 05 10 15 N/A	White
T24-DU10	1000+lm/ft	10'	8.3W/ft	01 05 10 N/A N/A	

Example: T24-DU4-20-A

CCT SELECT POWER SUPPLY

Model	Input	Output	Dimension	Description
PS-24DC-U60R-CS-DU PS-24DC-U96R-CS-DU	120-277VAC	24VDC, 60W 24VDC, 96W	7 ¹¹ / ₁₆ " x 3 ⁷ / ₈ " x 1 ³ / ₈ "	TRIAC/ELV/0-10V >0.9 pf Overload and short circuit protection PS-24DC-U60R-CS-DU and PS-24DC-U96R-CS-DU includes 6ft lead wire with connector Dual-switch design lets users select load type (1800K-4000K or 2700K-5000K) and choose from preset CCTs: 1800K-4000K mode: 1800K, 2700K, 3000K, 3500K, 4000K 2700K-5000K mode: 2700K, 3000K, 3500K, 4000K, 5000K
PS-24DC-U288R-CSDU	120-277VAC	24VDC, 3 X 96W	12 ¹⁵ / ₁₆ " x 4 ³ / ₄ " x 1 ³ / ₄ "	Non-dimmable Integral switch on/off Overload and short circuit protection Includes 6ft lead wire with connector Dual-switch design lets users select load type CCTs: 1800K-4000K mode: 1800K, 2700K, 3000K, 3500K, 4000K 2700K-5000K mode: 2700K, 3000K, 3500K, 4000K, 5000K
PS-24DC-60P-DU	120VAC	24VDC, 60W	2 ³ / ₄ " x 2 ¹ / ₂ " x 1 ³ / ₈ "	Non-dimmable Integral switch on/off Overload and short circuit protection Includes 6ft lead wire with connector Dual-switch design lets users select load type CCTs: 1800K-4000K mode: 1800K, 2700K, 3000K, 3500K, 4000K 2700K-5000K mode: 2700K, 3000K, 3500K, 4000K, 5000K
PS-24DC-96P-DU	120VAC	24VDC, 96W	4" x 2 ¹ / ₄ " x 1 ³ / ₈ "	Non-dimmable Integral switch on/off Overload and short circuit protection Includes 6ft lead wire with connector Dual-switch design lets users select load type CCTs: 1800K-4000K mode: 1800K, 2700K, 3000K, 3500K, 4000K 2700K-5000K mode: 2700K, 3000K, 3500K, 4000K, 5000K

TOUCH PANEL AND MOTION SENSOR

Model	Input	Description
CT-6A-R2	24VAC/DC (96W MAX)	Includes a Touch Panel, Occupancy Sensor and a Controller. Connect on secondary side of power supply

ACCESSORIES

Model	Finish	Description
T24-DU-PM-CL	Clear	Power to Tape Connector Connects power cable to tape (10 pieces per pack)
T24-DU-MM-CL	Clear	Tape to Tape Connector Connects tape sections (10 pieces per pack)
T24-DU-L-CL	Clear	Tape to Tape L Connector Connects tape sections (2 pieces per pack)
T24-DU-Y-WT T24-DU-Y-BK	White Black	Flex Y Connector Connects tape sections
T24-DU-X-WT T24-DU-X-BK	White Black	Flex X Connector Connects tape sections
T24-DU-IC-002 T24-DU-IC-006 T24-DU-IC-012 T24-DU-IC-036 T24-DU-IC-072	WT White BK Black	Joiner Cable Connects tape sections, 2 male ends In wall rated wire
T24-DU-EX2-072 T24-DU-EX2-144 T24-DU-EX2-240 T24-DU-EX2-480	WT White BK Black	Extension Cable Extends distance between a hard wire power supply or a wiring box to a tape section In wall rated wire
T24-DU-CL	Clear	Plastic Mounting Clip For installation on non-flat surfaces Include 10 pcs plastic mounting clips and 10 screw
LED-T-B	White	Low voltage Wiring Box Neatly house connections for up to 2 wires

COMPATIBLE WITH WAC HOME

WAC Home is a connected lighting ecosystem that brings intuitive, whole-home control to recessed lights, tape light, pucks, light sheets, and decorative fixtures. With smart tuning, wireless control, and high-quality LED performance, the system effortlessly adapts to your routines, your mood, and your home.

Visit wacighting.com/wac-home to learn more.

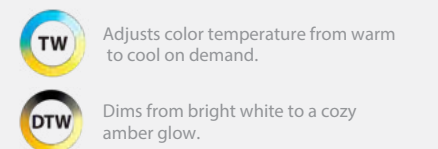

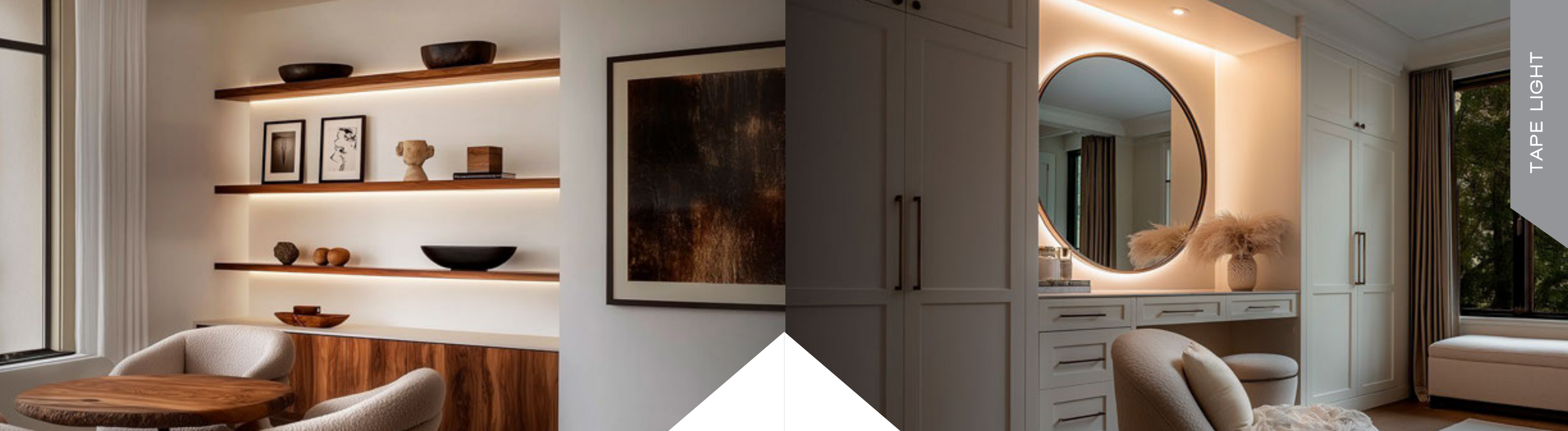

INVISIBLE LITE+

DAMP RATED 150 LM/FT TAPE LIGHT



Power: 2.2W / ft
 Lumens: 150 lm / ft
 CRI: 90+
 Rated Life: 50,000 hours

- Specially rated for installation in storage areas of a clothes closet
- 2200K has yellow COB, 2700K-4500K has white COB as shown in images above
- UV stabilized coating protects LEDs and circuitry for long term use in damp locations
- May be field cut every 2" at the end of a run
- Includes an end cap
- Max run length of 40' with 96W power supply
- 2 conductors wire between tape and power supply

Tape Selections	Model	Color Temp	Length	Quantity	Finish
	LED-TA24	22 2200K	2IN 2"	1	White
		27 2700K	2IN-10 2"	10	
		30 3000K	1 1'	1	
		35 3500K	5 5'	1	
		45 4500K	1-40 1'	40	
Example: LED-TA2427-5					

"L" Connector	Model	Color Temp	Length	Finish
	LED-TA24	22 2200K	L	White
		27 2700K		
		30 3000K		
		35 3500K		
		45 4500K		
Example: LED-TA2427-L				

See pages 12-13 for required power supplies, optional controls, and additional mounting and wiring accessories.

INVISIBLE PRO+

DAMP RATED 200 LM/FT TAPE LIGHT



Power: 2.9W / ft
 Lumens: 200 lm / ft
 CRI: 90+
 Rated Life: 50,000 hours

- Specially rated for installation in the storage area of a clothes closet
- 2200K has yellow COB, 2700K-4500K has white COB as shown in images above
- UV stabilized protective coating protects LEDs and circuitry for long term use in damp locations
- May be field cut every 2" at the end of a run
- Includes an end cap
- Maximum run length of 33' with 96W power supply
- 2 conductors wire between tape and power supply

Tape Selections	Model	Color Temp	Length	Quantity	Finish
	LED-TB24	22 2200K	2IN 2"	1	White
		27 2700K	2IN-10 2"	10	
		30 3000K	1 1'	1	
		35 3500K	5 5'	1	
		45 4500K	1-40 1'	40	
Example: LED-TB2427-5					

"L" Connector	Model	Color Temp	Length	Finish
	LED-TB24	22 2200K	L	White
		27 2700K		
		30 3000K		
		35 3500K		
		45 4500K		
Example: LED-TB2427-L				

See pages 12-13 for required power supplies, optional controls, and additional mounting and wiring accessories.

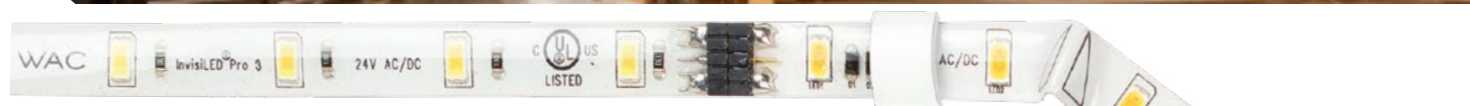

INVISILED PRO 2+

DAMP RATED 300 LM/FT TAPE LIGHT



Power: 4.1W / ft
Lumens: 300 lm / ft
CRI: 90+
Rated Life: 50,000 hours

- Specially rated for installation in the storage area of a clothes closet
- 2200K has yellow COB, 2700K-4500K has white COB as shown in images above
- UV stabilized protective coating protects LEDs and circuitry for long term use in damp locations
- May be field cut every 2" at the end of a run
- Includes an end cap
- Max run length of 25' with 96W power supply
- 2 conductors wire between tape and power supply

Tape Selections	Model	Color Temp	Length	Quantity	Finish
	22	2200K	2IN	2"	1
	27	2700K	2IN-10	2"	10
	30	3000K	1	1'	1
	35	3500K	1-40	1'	40
	45	4500K	5	5'	1

Example: LED-TC2427-5

"L" Connector	Model	Color Temp	Length	Finish
	22	2200K	L	White
	27	2700K		
	30	3000K		
	35	3500K		
	45	4500K		

Example: LED-TC2427-L

See pages 12-13 for required power supplies, optional controls, and additional mounting and wiring accessories.

INVISILED PRO 3

DAMP RATED 450 LM/FT TAPE LIGHT



Power: 5W / ft
Max Lumens: 475 lm / ft
CRI: Up to 95
Rated Life: 70,000 hours

- Ideal in straight or curved ceiling covers for general illumination
- Laterally bendable design
- UV stabilized coating protects LEDs and circuitry for long term use in damp locations
- May be field-cut every 6" at the end of a run
- Includes an end cap and a male to male connector with each tape section
- Max run length of 20' with 96W power supply
- 2 conductors wire between tape and power supply

Tape Selections	Model	Color Temp	CRI	Length	Quantity	Finish
	27	2700K	95	6IN	6"	1
	30	3000K	95	1	1'	1
	35	3500K	90	5	5'	1
	45	4500K	90	1-40	1'	40

Example: LED-TE2445-6IN-WT

See pages 12-13 for required power supplies, optional controls, and additional mounting and wiring accessories.

Laterally bendable over marked signs

Curve clip LED-T-CL1 shown

Field-cutable every 6" at the end of a run



INDOOR TAPE ACCESSORIES

	Model	Dimension	Finish	Description
	LED-TC-WEXT-144	12'	Black	In Wall Rated Extension Cable Extends distance between a hard wired power supply or a wiring box to a tape section.
	LED-TC-WEXT-144-WT	12'	White	
	LED-TC-WEXT-240	20'	Black	
	LED-TC-WEXT-240-WT	20'	White	
	LED-TC-WIC-144	12'	Black	In Wall Rated Joiner Cable Connects tape sections. 2 female ends. 1 male to male connector included.
	LED-TC-WIC-144-WT	12'	White	
	LED-TC-WIC-240	20'	Black	
	LED-TC-WIC-240-WT	20'	White	
	LED-TC-P-2	2'	Black	Lead Wire Alternative lengths for plug-in power supplies.
	LED-TC-P-2-WT	2'	White	
	LED-TC-P-12	12'	Black	
	LED-TC-P-12-WT	12'	White	
	LED-TC-EXT-144	12'	Black	Extension Cable Extends distance between a hard wired power supply or a wiring box to a tape section.
LED-TC-EXT-144-WT	12'	White		
	LED-TC-B-2	L: 12" W: w" H: d"	Black	Low Voltage Wiring Box With Feed Neatly houses connections for up to two wires with 12" female feed.
	LED-TC-B-2-WT		White	
	LED-T-B	L: 12" W: w" H: d"	White	Low Voltage Wiring Box Neatly houses connections for up to two wires.
	TB-S	L: 64" W: 1s" H: 14"	White	Wiring Box With Switch Use when spanning a large gap in a system layout without leaving exposed wiring. Optional switch included.
	LED-TC-IC2	2"	Black	Joiner Cable Connects tape sections.
	LED-TC-IC2-WT	2"	White	
	LED-TC-IC6	6"	Black	
	LED-TC-IC6-WT	6"	White	
	LED-TC-IC12	12"	Black	
	LED-TC-IC12-WT	12"	White	
	LED-TC-IC36	36"	Black	
	LED-TC-IC36-WT	36"	White	
	LED-TC-IC72	72"	Black	
LED-TC-IC72-WT	72"	White		
	LED-TC-MM		Black	Connector Male to male connector (pack of 50). Change directionality of tape runs and reuse cut ends of tape.
	LED-TC-Y		Black	3-Way "Y" Connector Connects tape sections.
	LED-TC-Y-WT		White	
	LED-TC-X		Black	4-Way "X" Connector Connects tape sections.
	LED-TC-X-WT		White	
	LED-TC-L		Black	"L" Connector Connects tape sections.
	LED-TC-L-WT		White	
	LED-TC-EC		Black	End Cap 1 cut and 1 male end cap.
	LED-TC-EC-WT		White	
	CT-6A-R2			Control Kit Includes a Touch Panel, Occupancy Sensor and a Controller AC/DC input at 12V(60W Max) or 24V(96W Max) Connect on secondary side of driver/transformer.
	IR-96-24VACDC-BK IR-96-24VACDC-WT	1a" x w" x a"	Black White	Infrared (IR) Sensor Switch IR (Infrared) sensor switch works by turning the lights on when it becomes unobstructed. Can be surface mounted with bracket provided or double sided adhesive. Input/Output: 24V AC/DC 96W

Compatible with Lite+, Pro+, Pro 2+, Pro 3

COMPATIBLE CLASS 2 POWER SUPPLY (REQUIRED)

FOR LITE+, PRO+, PRO 2+ AND PRO 3

	Model	Input	Output	Dimming	Description	
	EN-2460-RB2-T EN-24100-RB2-T	Remote	120VAC	24VAC / 60W 24VAC / 96W	100%-5% ELV	Includes a 6' lead wire. UL Class 2 output.
	PS-24DC-U60R-T PS-24DC-U96R-T	Remote	120-277VAC	24VDC / 60W 24VDC / 96W	100%-5% ELV, TRIAC	Includes a 6' lead wire. UL Class 2 output.
	PS-24DC-U3X96R-T	Remote	120-277VAC	24VDC / 3 x 96W	100%-5% ELV, TRIAC, 0-10V	Includes 3 x 6' lead wires, 3 output channels, UL Class 2 output.
	EN-24100-277-RB2-T	Remote	277VAC	24VDC / 96W	100%-5% 0-10V	Includes a 6' lead wire. UL Class 2 output.
	EN-2460-P-AR-T EN-24100-P-AR-T	Plug-in	120VAC	24VAC / 60W 24VAC / 96W	Non Dimmable	Includes a 6' lead wire. UL Class 2 output.
	EN-D24100-120-R	Wall Dimmer & Driver	120VAC	24VDC / 96W	Integral	No minimum load Single Pole preset dimmer with on/off push switch Three face plates included: Glossy Dark Brown, Glossy Light Almond, and Glossy White (trim plates not included)
	EN-D24060-120-R EN-D24096-120-R	Wall Dimmer & Driver	120VAC	24VDC / 60W 24VDC / 96W	Integral	Preset dimmer with on/off switch 3-way switches No minimum load



GEMINI



Input: 24VDC
Lumens: Up to 300 lm/ft
Rated Life: 50,000 hours

- Cutable every 2 inches for precise customization in the field
- Re-connectable using secure screw terminal accessories for quick, reliable installation
- Delivers uniform, consistent illumination along the entire run
- Creates a seamless, continuous line of light for a clean architectural finish

	Lumens	Max Run	Wattage	Length	Description	Color Temp	CRI	Finish
T24-GE1	100+ lm/ft	40ft (60W), 40 ft (96W)	1.2W/ft	15	15 ft spool (includes 2 pcs Tape to Tape Connector)	27 2700K		
T24-GE2	200+ lm/ft	24ft (60W), 30ft (96W)	2.2W/ft	24	24 ft spool (includes 4 pcs Tape to Tape Connector)	30 3000K 35 3500K	90	WT White
T24-GE3	300+ lm/ft	15ft (60W), 24ft (96W)	3.9W/ft	100	100 ft spool (includes 10 pcs Tape to Tape Connector)	40 4000K		

Example: T24-GE3-15-27WT



GEMINI KIT

Everything you need for a seamless single-CCT linear lighting installation. Designed for quick setup and reliable performance, these curated kits ensure compatibility, efficiency, and lasting quality for any project.

THE KIT INCLUDES:

- One 15-foot roll of Gemini Tape 300 (24VDC)
- 96W remote power supply (24VDC)
- 12-foot white extension cable
- Ten power-to-tape connectors
- Three tape-to-tape connectors

Gemini Kit	Lumens	Max Run	Wattage	Length	Color Temp	CRI	Finish
T24-GE3-15-27KIT					2700K		
T24-GE3-15-30KIT	300+ lm/ft	15ft (60W), 24ft (96W)	3.9W/ft	15 ft spool	3000K	90	White
T24-GE3-15-35KIT					3500K		

Example: T24-GE3-15-30KIT

POWER SUPPLY

Type	Model	Dimension	Input	Output	Dimming
Portable Power Supply Include 6' lead wire Integral on-off switch	PS-24DC-60P-GE	4" x 2 ³ / ₁₆ " x 1 ¹ / ₂ "	120V	24VDC 60W	Non Dimmable
Remote Power Supply ELV Dimming 100%-10% Include 6' lead wire	EN-BT60-24* EN-BT96-24*	6 ¹ / ₂ " x 2 ¹ / ₁₆ " x 1 ¹ / ₄ " 6 ¹ / ₂ " x 2 ¹ / ₁₆ " x 1 ¹ / ₄ "	120V	24VDC 60W 24VDC 96W	ELV
Remote Power Supply TRIAC, ELV Dimming 100%-1% Universal Input, ≤ 0.9 pf	PS-24DC-U60R-BT PS-24DC-U96R-BT	8 ¹ / ₁₆ " x 2 ¹ / ₁₆ " x 1 ¹ / ₄ " 8 ¹ / ₁₆ " x 2 ¹ / ₁₆ " x 1 ¹ / ₄ "	120V-277V	24VDC 60W 24VDC 96W	ELV/TRIAC
Remote Power Supply 3 x 96W outputs (288W total) Include 3 x 6' lead wires	PS-24DC-U3X96R-BT	12" x 4 ⁵ / ₁₆ " x 2"	120V-277V	24VDC 3 x 96W	ELV/TRIAC/0-10V
Wall Dimmer & Driver Preset dimmer with on/off switch 3-way switches. No minimum load.	EN-D24060-120-R EN-D24096-120-R	1 ¹ / ₁₆ " x 2 ¹ / ₁₆ " x 2 ³ / ₄ "	120VAC	24VDC / 60W 24VDC / 96W	Integral

*Not compatible with Touch Panel and Motion Sensor (CT-6A-R2) or IR sensor (IR-96-24VACDC).

ACCESSORIES

Type	Model	Finish
Tape to Tape Connector Connects tape sections (10 pieces per pack)	T24-BS-MM	CL Clear
Power to Tape Connector Connects power cable to tape (10 pieces per pack)	T24-BS-PM	CL Clear
L Connector Connects tape sections (2 pieces per pack)	T24-BS-L	CL Clear
Flex Y Connector Connects tape sections and power feed Includes LED-T-B (1pc)	T24-BS-Y	BK Black WT White
Flex X Connector Connects tape sections and power feed Includes LED-T-B (1pc)	T24-BS-X	BK Black WT White
Low Voltage Wiring Box Neatly house connections for up to 2 wires	LED-T-B	WT White

Example: T24-BS-MM-CL

Type	Model	Finish
Joiner Cable Extend distance between tape sections	T24-BS-IC-002 T24-BS-IC-006 T24-BS-IC-012 T24-BS-IC-036 T24-BS-IC-072	2 in 6 in 1 ft 3 ft 6 ft BK Black WT White
Extension Cable Extends distance between tape sections and power supply. Includes LED-T-B (1 pc) & screw driver.	T24-BS-EX2-072 T24-BS-EX2-144 T24-BS-EX2-240 T24-BS-EX2-480	6 ft 12 ft 20 ft 40 ft BK Black WT White

Example: T24-BS-EX2-240-WT

Model	Finish	Input	Dimension	Description
IR-96-24VACDC-BK IR-96-24VACDC-WT	Black White	24V AC/DC 96W	1 ³ / ₈ " x ³ / ₈ " x ³ / ₈ "	IR (Infrared) sensor switch works by turning the lights on when it becomes unobstructed. Can be surface mounted with bracket provided or double sided adhesive.

INDOOR ALUMINUM CHANNELS



Shallow Aluminum Channel	LED-T-CH5-BK LED-T-CH5-WT LED-T-CH5-AL	5'
Additional End Caps	LED-T-CH5-EC-BK LED-T-CH5-EC-WT LED-T-CH5-EC-AL	2 pcs

Includes a diffuser, 2 end caps, and 5 screws.



Aluminum Channel	LED-T-CH	5'
Additional End Caps	LED-T-CH-EC	2 pcs

Diffuses light from InvisiLED tape.
Includes a diffuser, 2 end caps, and 5 screws.



45° Angled Aluminum Channel	LED-T-CH2	5'
Additional End Caps	LED-T-CH2-EC	2 pcs

Includes a diffuser, 2 end caps, and 5 screws.



Deep Aluminum Channel	LED-T-CH1	5'
Additional End Caps	LED-T-CH1-EC	2 pcs

Eliminates visible hot spots.
Includes a diffuser, 2 end caps, and 5 screws.

INDOOR MOUNTING ACCESSORIES



Aluminum Retrofit Channel	LED-T-RC	3 feet
---------------------------	----------	--------

Can be bent to create fixed curves or used as a glare shield.



Clear Channel	LED-TO24-CH5	5 feet
---------------	--------------	--------

Compatible with InvisiLED Lite+, Pro+, Pro2+ and Pro3 only.



Fixed Angle Channel Clip	LED-T-CL3-PT
--------------------------	--------------

Includes 2 pieces, 4 screws. Use to mount Aluminum Channel.



Clip	LED-T-CL
------	----------

For surfaces that are difficult to adhere.
Includes: 10 pcs plastic clips and 10 pcs screws. Compatible with InvisiLED Lite+, Pro+, Pro2+ and Pro3 only.



Curve Clip	LED-T-CL1
------------	-----------

Clips to hold indoor InvisiLED tapes sections. Includes: 10 pcs plastic clips and 10 pcs screws. Compatible with InvisiLED Lite+, Pro+, Pro2+ and Pro3 only.



Clip	T24-BS-CL1
------	------------

Includes: 10 pcs plastic clips and 10 pcs screws for installation on non-flat surfaces
Compatible with Gemini Tape only.



Adjustable Channel Clip	LED-T-CL2-PT
-------------------------	--------------

Includes 2 pieces, 4 screws. Used to mount Aluminum Channel.
Adjust 50° from center either way.

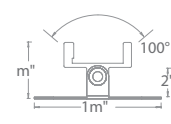

LEDME DUO

A PREMIUM UNDER-CABINET LIGHT STRIP BUILT FOR TOTAL FLEXIBILITY



Dimming: 100% – 10% smooth and continuous ELV and TRIAC
Rated Life: 54,000 hours



- Extruded aluminum construction for optimal thermal management
- Indirect diffused light source reduces glare and creates uniform illumination
- Captive screws for easy installation
- Multiple knock outs for ease of wiring
- Thin 1" profile
- 120VAC—no driver needed
- Non-metallic sheathed cable connectors included
- One "I" connector included with each luminaire

ALL-IN-ONE CCT SELECTABLE



Model	Length	Color Temp	CRI	Power	Max Lumens	Finish
BA-ACLED8-27/30	8"	2700K 3000K	90	6W	330	AL Brushed Aluminum BZ Bronze WT Anti-Microbial White
BA-ACLED12-27/30	12"			8W	475	
BA-ACLED18-27/30	18"			10W	545	
BA-ACLED24-27/30	24"			15W	930	
BA-ACLED30-27/30	30"			17.5W	1095	
BA-ACLED36-27/30	36"			19.5W	1305	
BA-ACLED42-27/30	42"	22.5W	1445			

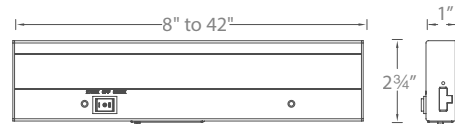

Example: BA-ACLED12-27/30AL

Anti-microbial powder coat proven to restrain a wide range of bacteria, coliform, mold, fungus, algae and yeast.

- May be hard-wired with 120V power or used with a plug-in power cord
- Subsequent fixtures may be powered with an "I" Connector or Interconnect Cable carrying 120V
- May be individually switched and/or wired to a wall box switch/dimmer

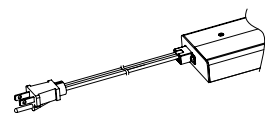

Power Cord

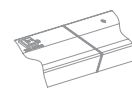

"I" Connector

Using a 98% efficient reflector, light from the LED sources is diffused to create evenly distributed illumination.

Interconnect Cable

Model	Length	Finish	Model	Max Fixture Run	Model	Length	Max Fixture Run	Finish
BA-PC6	6'	BK Black WT White	BA-I-WT	6	BA-IC12	12"	4	BK Black
					BA-IC24	24"	4	WT White
					BA-IC36	36"	3	WT White

Supplies power in any application.

Interconnection for seamless end-to-end transitions. Each light bar includes one.

Links two light bars using a single power connection.

BARLIGHT

UNDER CABINET ILLUMINATION



Input: 120V
Dimming: 100%-10% ELV, 100%-5% TRIAC
Rated Life: 50,000 hours

- A rocker switch allows easy adjustment between 0% 50%, or 100% brightness levels
- Constructed from aluminum with a white polycarbonate diffuser for clean, even illumination

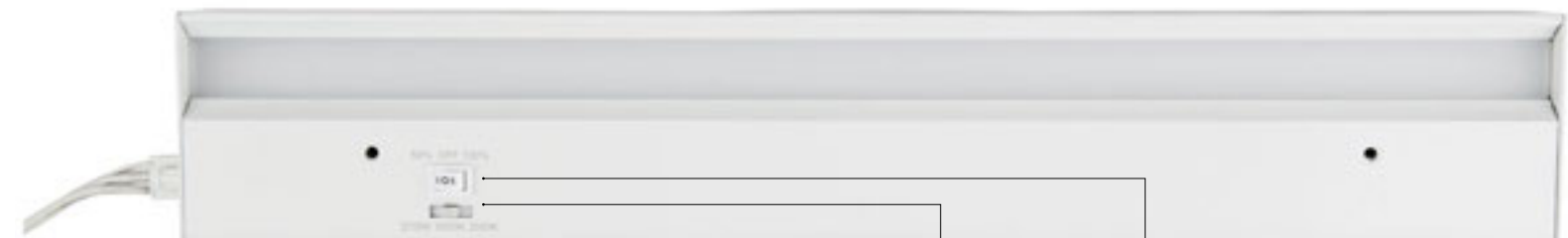

ALL-IN-ONE CCT SELECTABLE



Rocker Switch adjusts between 50%, OFF, or 100%



All-in-one CCT Selectable. Adjusts between 2700K, 3000K or 3500K

Model	Length	Wattage	Max Lumens at 3000K	Color Temp	CRI	Finish
BA-AC	08	8"	7W	355	CS 3000K 3500K	90 WT White
	18	18"	11W	600		
	24	24"	15W	910		
	30	30"	18W	1075		

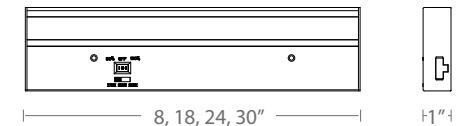

Example: BA-AC18-CS-WT

Model	Description	Length	Finish
BA-I	"I" Connector BA-I		WT White
BA-IC12	Interconnect Cable BA-IC	12"	WT White
BA-IC24		24"	
BA-IC36		36"	
BA-PC6	Power Cord	72"	WT White



UNDER CABINET STRIP PLUG & PLAY



Input: 24VDC
Dimming: 100-10% ELV, 100-10% TRIAC
Rated Life: 50,000 hours

- Connect multiple sections for a seamless, continuous run of light
- Easily mount using clips, endcaps, and joiner accessories for a secure installation
- Create a complete working system with just one length and one power supply
- Constructed from durable aluminum with a polycarbonate diffuser for even light distribution

Accessories Included



Model	Length	Wattage	Color Temp	Finish
LU	08 8"	3W 140	27 2700K 30 3000K	90 AL Aluminum BK Black
	20 20"	6W 360		
	40 40"	12W 700		

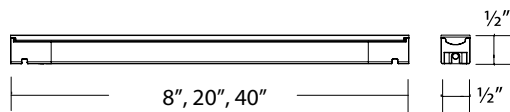

Example: LU-20-30-BK

POWER SUPPLY

Type	Model	Dimension	Input	Output
Portable Power Supply Includes 6' lead wire Integral on-off switch	LU-2460D-P-BK	4" x 2 ³ / ₁₆ " x 1 ¹ / ₂ "	120V	24VDC 60W
Portable Power Supply Includes 6' lead wire	LU-2420D-P-BK LU-2420D-P-WT	2 ³ / ₄ " x 1 ⁵ / ₈ " x 1 ¹ / ₈ "	100V-240V	24VDC 20W
Portable Power Supply Includes 6' lead wire TRIAC, ELV Dimming Universal Input	LU-24DC060-UNV-RB2 LU-24DC096-UNV-RB2	8 ³ / ₁₆ " x 2 ¹ / ₁₆ " x 2 ¹ / ₄ " 8 ³ / ₁₆ " x 2 ¹ / ₁₆ " x 2 ¹ / ₄ "	100V-277V	24VDC 60W 24VDC 96W
Wall Dimmer & Driver Preset dimmer with on/off switch 3-way switches. No minimum load. Live End cable accessory is required and sold separately.	EN-D24060-120-R EN-D24096-120-R	1 ¹ / ₁₆ " x 2 ¹ / ₁₆ " x 2 ³ / ₄ "	120VAC	24VDC / 60W 24VDC / 96W

ACCESSORIES

Type	Model	Length	Finish
Joiner Cable Extend distance between sections	LU-IC02 LU-IC06 LU-IC12 LU-IC36 LU-IC72	2" 6" 12" 3' 6'	Gray
I-Connector Connect two strip lights side-by-side	LU-I		Gray
Live End Connect strip light to low voltage power supply	LU-LE06 LU-LE72	6" 72"	Gray
Multiple Terminal Block Enclosure to allow up to 6 output connections	MTB-01 MTB-01-WT		Black White
End Caps Cover the end of each run	LU-EC		Gray
Fixed Base Mount strip light flush to surface	LU-FB		Gray
Angled Base Mount strip light at an angle	LU-AB		Gray



BUTTON & PUCK

Compact and targeted by design, WAC Lighting's button and puck fixtures provide focused illumination for cabinetry, shelving, displays, and architectural details. Their unobtrusive presence allows light to remain the focus rather than the fixture itself.

Simple to install and easy to integrate, these fixtures deliver dependable accent and task lighting across residential and light commercial applications.

DUET BUTTON LIGHTS

TWO-WIRE SYSTEM FOR POWER AND CONTROL



Power: 24V, 3.5W
Dimming: TRIAC/ELV/0-10V
Rated Life: 50,000 hours
Cutout: 2 1/8" for round recessed applications



HR2R-DU-A-BK



HR2S-DU-A-WT

CCT selectable output on the physical power supply switch



	Model	Color Temp	CRI	Max Lumens	Finish
	HR2R-DU Round	A 1800-4000K	90	230	BK Black BN Brushed Nickel CB Copper Bronze DB Dark Bronze WT White
	HR2S-DU Square	A 1800-4000K	90	185	BK Black BN Brushed Nickel CB Copper Bronze DB Dark Bronze WT White

Example: HR2R-DU-A-WT Includes 6 foot lead wire

CCT Select Power Supply	Model	Input	Output	Dimension	Description
	PS-24DC-U60R-CS-DU PS-24DC-U96R-CS-DU	120-277VAC	24VDC, 60W 24VDC, 96W	7 11/16" x 3 7/8" x 1 3/8"	TRIAC/ELV/0-10V >0.9 pf Overload and short circuit protection PS-24DC-U60R-CS-DU & PS-24DC-U96R-CS-DU includes 6ft lead wire with connector
	PS-24DC-U288R-CSDU	120-277VAC	24VDC, 3 X 96W	12 15/16" x 4 3/4" x 1 3/4"	Dual-switch design lets users select load type (1800K-4000K), choose from preset
	PS-24DC-60P-DU	120VAC	24VDC, 60W	2 3/4" x 2 13/16" x 1 3/8"	Non-dimmable Integral switch on/off Overload and short circuit protection
	PS-24DC-96P-DU	120VAC	24VDC, 96W	4" x 2 1/4" x 1 3/8"	Includes 6ft lead wire with connector Dual-switch design lets users select load type

Touch Panel & Motion Sensor	Model	Input	Description
	CT-6A-R2	24VAC/DC (96W MAX)	Includes a Touch Panel, Occupancy Sensor and a Controller. Connect on secondary side of power supply

COMPATIBLE WITH WAC HOME

WAC Home is a connected lighting ecosystem that brings intuitive, whole-home control to recessed lights, tape light, pucks, light sheets, and decorative fixtures. With smart tuning, wireless control, and high-quality LED performance, the system effortlessly adapts to your routines, your mood, and your home.

Visit wacighting.com/wac-home to learn more.



Adjusts color temperature from warm to cool on demand.



Dims from bright white to a cozy amber glow.



BUTTON LIGHTS

24V LED



Power: 24V, 4.8W
Dimming: 100% - 10%
Rated Life: 70,000 hours
Cutout: 2 1/8" for round recessed applications



HR-LED87-BN



HR-LED87S-WT

Recessed or Surface Mount with 24V transformer	Model	Color Temp	CRI	Max Lumens	Finish
	HR-LED87	27 2700K	85	180	BK Black
	Round	30 3000K			BN Brushed Nickel
	HR-LED87S	27 2700K	85	155	BK Black
	Square	30 3000K			BN Brushed Nickel
					CB Copper Bronze
					DB Dark Bronze
					WT White

Example: HR-LED87S-WT Includes 6 foot lead wire.

CLASS 2 ELECTRONIC TRANSFORMERS (Required)

- Plug-in power supply with on/off toggle switch and 6' detachable cord
- 1W minimum load
- Minimizes wiring back to transformer

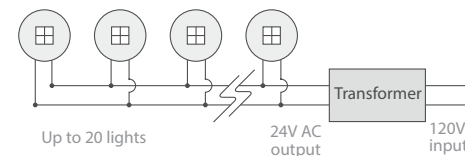

Model	Output	Input	Dimmable	Max Fixture Run	Dimensions
EN-2460-RB2	24VAC, 60W	120VAC	100%-5% ELV	12 x LED87	6 1/2" x 1 5/8" x 1 3/4"
EN-24100-RB2	24VAC, 96W	120VAC	100%-5% ELV	20 x LED87	6 1/2" x 1 5/8" x 1 3/4"
EN-24100-277-RB2-T	24VDC, 96W	120V-277VAC	100%-1% 0-10V	20 x LED87	12 5/8" x 3 3/4" x 2"
EN-24DC060-UNV-RB2	24VDC, 60W	120V-277VAC	TRIAC, ELV	12 x LED87	8 13/16" x 2 1/2" x 2 1/4"
EN-24DC096-UNV-RB2	24VDC, 96W	120V-277VAC	TRIAC, ELV	20 x LED87	12 5/8" x 3 3/4" x 2"
EN-2460-P-AR	24VAC, 60W	120VAC	Non Dimmable	12 x LED87	2 3/4" x 1 5/8" x 1 3/4"
MTB-01	Multiple Terminal Box 12.5A max accommodates up to 6 output connections for 14 AWG wires. Terminal block is used to easily wire together multiple output connections for a neat under cabinet installation without the use of open splices. 3 1/4" L x 1 3/4" W x 7/8" H				
MTB-01-WT	Black				
	White				
EN-D24060-120-R	24VDC / 60W	120VAC	Integral	12 x LED87	1 11/16" x 2 1/16" x 2 3/4"
EN-D24096-120-R	24VDC / 96W	120VAC	Integral	20 x LED87	1 11/16" x 2 1/16" x 2 3/4"

Plug-in power supply with on/off switch and 6' detachable cord

Preset dimmer with on/off switch 3-way switches No minimum load

Retrofit Housing	Model	Finish
	HR-LED-COV	BK Black
		BN Brushed Nickel
		CB Copper Bronze
		DB Dark Bronze
		WT White

Example: HR-LED-COV-BK

FROSTED LENS ACCESSORY

LENS-13-FR Softens light and reduces glare for square or round

LED90

EDGE-LIT BUTTON LIGHT



Power: 24V, 5W
Dimming: 100% - 5%
Rated Life: 100,000 hours
Cutout: 3 1/4" for recessed applications



Dark Bronze



White



Black



Brushed Nickel

- Can be surface or recessed mounted
- Super thin profile at 2"
- Edge-lit LEDs reduce glare and ensure even light distribution
- Anti-microbial white powder coat
- ELV dimming

Surface Mounted	Recessed	Model	Color Temp	CRI	Max Lumens	Finish
		HR-LED90	27 2700K	90	200	BK Black
			30 3000K			BN Brushed Nickel
						DB Dark Bronze
						WT White

Example: HR-LED90-30-BN Includes 6 foot lead wire

CLASS 2 ENCLOSED ELECTRONIC TRANSFORMERS (Required)

Model	Output	Input	Dimmable	Max Fixture Run	Dimensions
EN-2460-RB2	24VAC, 60W	120VAC	100%-5% ELV	7 x LED90	6 1/2" x 1 5/8" x 1 3/4"
EN-24100-RB2	24VAC, 96W	120VAC	100%-5% ELV	10 x LED90	6 1/2" x 1 5/8" x 1 3/4"
EN-24100-277-RB2-T	24VDC, 96W	120V-277VAC	100%-1% 0-10V	10 x LED90	12 5/8" x 3 3/4" x 2"
EN-24DC060-UNV-RB2	24VDC, 60W	120V-277VAC	TRIAC, ELV	7 x LED90	8 13/16" x 2 1/2" x 2 1/4"
EN-24DC096-UNV-RB2	24VDC, 96W	120V-277VAC	TRIAC, ELV	10 x LED90	12 5/8" x 3 3/4" x 2"
EN-2460-P-AR	24VAC, 60W	120VAC	Non Dimmable	7 x LED90	2 3/4" x 1 5/8" x 1 3/4"
MTB-01	Multiple Terminal Box 12.5A max accommodates up to 6 output connections for 14 AWG wires. Terminal block is used to easily wire together multiple output connections for a neat under cabinet installation without the use of open splices. 3 1/4" L x 1 3/4" W x 7/8" H				
MTB-01-WT	Black				
	White				
EN-D24060-120-R	24VDC / 60W	120VAC	Integral	7 x LED90	1 11/16" x 2 1/16" x 2 3/4"
EN-D24096-120-R	24VDC / 96W	120VAC	Integral	10 x LED90	1 11/16" x 2 1/16" x 2 3/4"

Plug-in power supply with on/off switch and 6' detachable cord

Preset dimmer with on/off switch 3-way switches No minimum load





- Secondary wiring for Class 2 transformers does not require conduit sheathed cable or clamp wiring techniques
- Intrinsically safe, Class 2 transformers permit no greater than a 5 amp current to be drawn
- Non-metallic sheathed cable may be used for secondary wiring in walls and ceilings
- Power consumption may vary depending on the efficiency of the power supply being used

MINI PUCK LIGHT







Input: 24VAC or 24VDC
Dimming: 100%-10% ELV, 100%-5% TRIAC
Rated Life: 50,000 hours

- Installs as either a surface mount or recessed mount for versatile applications
- Compatible with a portable wall plug or hardwired 24V driver/transformer
- Constructed from die-cast aluminum with a polycarbonate diffuser for durability and even illumination
- Each fixture includes 6 feet of lead wire for convenient installation

	Model	Wattage	Lumens	Color Temp	CRI	Finish
	HR-LED10 1 single light	2W per light	95lm per light	30 3000K	90	BK Black WT White
	HR-LED10/6 Pack of 6 lights	2W per light	95lm per light	30 3000K	90	BK Black WT White
	HR-LED10/10 Pack of 10 lights	2W per light	95lm per light	30 3000K	90	BK Black WT White
	HR-LED10/6K Puck Light Kit: • Six wired lights • One multiple terminal block • 24V Portable Power Supply	2W per light	95lm per light	30 3000K	90	BK Black WT White

Example: HR-LED10-30-BK

24VDC Class 2 Power Supply	Model	Dimensions	Input	Output	Dimming	Finish
	Portable Power Supply EN-2420D-P-BK EN-2420D-P-WT	2¾" x 1½" x 1½"	100V-240V	24VDC 24W	Non-Dimmable	Black White
	Remote Power Supply EN-24DC060-UNV-RB2 EN-24DC096-UNV-RB2	8½" x 2½" x 2¼"	100V-277V	24VDC 60W 24VDC 96W	TRIAC, ELV	Black
	Wall Dimmer & Driver EN-D24060-120-R EN-D24096-120-R	1½" x 2½" x 2¾"	120VAC	24VDC / 60W 24VDC / 96W	Integral	White

24VAC Class 2 Power Supply	Model	Dimensions	Input	Output	Dimming	Finish
	Portable Power Supply EN-2460-P-AR	2¾" x 1½" x 1¾"	120V	24VAC 60W	Non-Dimmable	Black
	Remote Power Supply EN-2460-RB2 EN-24100-RB2	6½" x 1½" x 1¼"	120V	24VAC 60W 24VAC 100W	ELV	Black

Multiple Terminal Block	Model	Description	Finish
	MTB-01 MTB-01-WT	Multiple Terminal Block (Enclosure for up to 6 output connections)	Black White

PUCK LIGHT



Input: 120V
Dimming: 100%-10% ELV
Rated Life: 50,000 hours



ALL-IN-ONE CCT SELECTABLE



- Installs as either a surface mount or recessed mount for versatile applications
- Operates without the need for an external driver
- Engineered from die-cast aluminum with a PC diffuser for refined light distribution

	Model	Wattage	Max Lumens	Color Temp	CRI	Finish
	HR-AC70 1 single wired light	4W	290	2700K CS 3000K 3500K	90	BK Black BN Brushed Nickel WT White
	HR-AC71 1 single wired light and cord	4W	290	2700K CS 3000K 3500K	90	BK Black BN Brushed Nickel WT White
	HR-AC72 1 double wired light	4W	290	2700K CS 3000K 3500K	90	BK Black BN Brushed Nickel WT White
	HR-AC73 Puck light kit: 2 double wired lights, 1 single wired light, and cord	4W x 3	290 x 3	2700K CS 3000K 3500K	90	BK Black BN Brushed Nickel WT White

Example: HR-AC72-CS-BN

Accessories	Model	Description	Length	CRI	Finish
	HR-PC6	Power Cord	6'	90	BK Black WT White
	HR-HWB	Hardware Box		90	BK Black WT White
	HR-IC	Linking Cable	12 12" 24 24" 36 36"	90	BK Black WT White



120V TRACK SYSTEM

Flexible and adjustable, track lighting from WAC Lighting supports spaces that require adaptability and precise control. Fixtures can be positioned and aimed as layouts evolve, making track an effective solution for changing lighting needs.

Commonly used in kitchens, living areas, retail, and multi-use environments, track lighting offers straightforward installation with consistent performance and clean visual organization.

OCULARC 7011



- Integrated 5CCT Switch: 2700K, 3000K, 3500K, 4000K, 5000K
- Integral driver and high output COB LED
- 350° horizontal and 90° vertical aiming
- Three interchangeable beam options included
 - » 60° beam film pre-installed
 - » 30° film supplied
 - » 17° spot beam, remove all films

Power: 11W
Input: 120V
Comparable to: 65W MR16
Dimming: 100% - 10% ELV, TRIAC
Rated Life: 50,000 hours

CCT Selection Switch Onboard

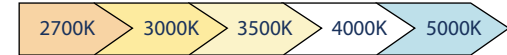

OCULARC TRACK PACK 7011/3



- Track pack includes:
- 4ft H-Track
 - Floating Canopy
 - Three 7011-CS Ocularc Track Heads



System	Model	Color Temp	CRI	Beam	Max Lumens	Max CBCP	Finish	
H L J	HTrack LTrack J/J2 Track	7011 CS	90	2700K	17°	1025	3935	BK Black
				3000K	30°	955	1520	BN Brushed Nickel
				3500K	60°	920	670	DB Dark Bronze*
				4000K				WT White
				5000K				

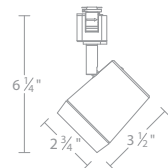

Example: H-7011-CS-DB

*Only available in H Track

System	Model	Color Temp	CRI	Beam	Max Lumens	Max CBCP	Finish	
H	HTrack	7011/3 CS	90	2700K	17°	1025 x3	3935 x3	BK Black
				3000K	30°	955 x3	1520 x3	WT White
				3500K	60°	920 x3	670 x3	
				4000K				
				5000K				

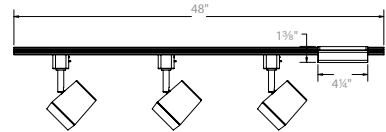

Example: H-7011/3-CS-WT

REPLACEMENT OPTICS

- FILM-16-N Narrow Flood Optic
- FILM-16-F Flood Optic

INTERCHANGEABLE BEAM OPTIONS:

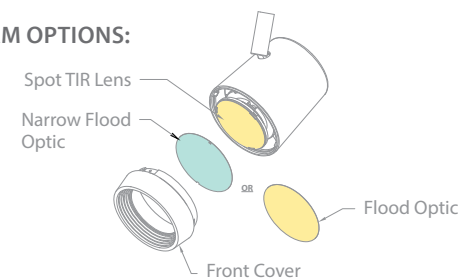

OCULARC DIM-TO-WARM 7011



- Dim-to-warm color temperature range: 3000K-1800K
- Two beam angle optics included (see diagram):
 - » 55° optic pre-installed, easily removable
 - » 30° optic interchangeable component
- Integral driver and high output COB LED
- Outperforms halogen 50W MR16
- 350° horizontal and 90° vertical aiming

Power: 11.5W
Input: 120V
Comparable to: 50W MR16
Dimming: 100% - 10% ELV, TRIAC
Rated Life: 54,000 hours

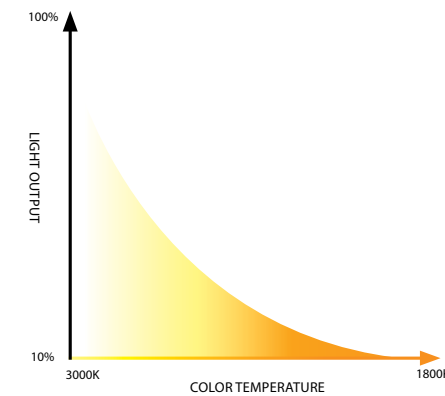

System	Model	Color Temp	CRI	Beam	Max Lumens	Max CBCP	Finish	
H L J	HTrack LTrack J/J2 Track	7011 WD	95	3000K-1800K	30°	605	1133	BK Black
				55°	580	484	BN Brushed Nickel	
							DB Dark Bronze	
							WT White	

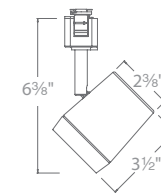

Example: H-7011-WD-WT

REPLACEMENT OPTICS

- FILM-16-N 30° Narrow Flood
- FILM-16-F 55° Flood

INTERCHANGEABLE BEAM OPTIONS:

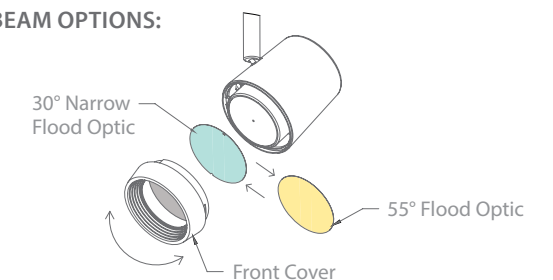

OCULARC 7012



- Integrated 5CCT Switch: 2700K, 3000K, 3500K, 4000K, 5000K
- Integral driver and high output COB LED
- 350° horizontal and 90° vertical aiming
- Three interchangeable beam options included:
 - » 60° beam film pre-installed
 - » 30° film supplied
 - » 17° spot beam, remove all films

Power: 11W
Input: 120V
Comparable to: 65W MR16
Dimming: 100% - 10% ELV, TRIAC
Rated Life: 50,000 hours

OCULARC 7013



- Integrated 5CCT Switch: 2700K, 3000K, 3500K, 4000K, 5000K
- Integral driver and high output COB LED
- 350° horizontal and 90° vertical aiming
- Three interchangeable beam options included:
 - » 60° beam film pre-installed
 - » 30° film supplied
 - » 17° spot beam, remove all films

Power: 11W
Input: 120V
Comparable to: 65W MR16
Dimming: 100% - 10% ELV, TRIAC
Rated Life: 50,000 hours

CCT Selection Switch Onboard



CCT Selection Switch Onboard



	System	Model	Color Temp	CRI	Beam	Max Lumens	Max CBCP	Finish	
	H	H Track	2700K		17°	1025	3935	BK Black WT White	
	L	L Track	3000K		30°	955	1520		
	J	J/J2 Track	3500K	90	60°	920	670		
			4000K						
			5000K						
	Example: H-7012-CS-BK								

	System	Model	Color Temp	CRI	Beam	Max Lumens	Max CBCP	Finish	
	H	H Track	2700K		17°	1000	3200	BK Black WT White	
	L	L Track	3000K		30°	920	1365		
	J	J/J2 Track	3500K	90	60°	890	640		
			4000K						
			5000K						
	Example: H-7013-CS-WT								

REPLACEMENT OPTICS

- FILM-15-N** Narrow Flood Optic
- FILM-15-F** Flood Optic

INTERCHANGEABLE BEAM OPTIONS:

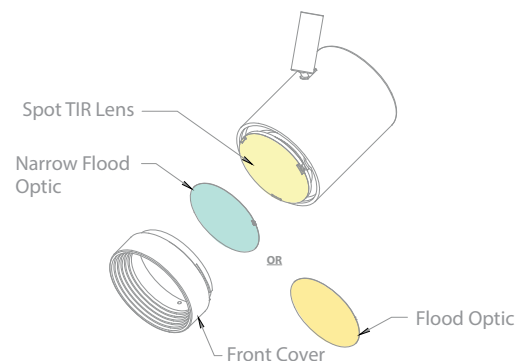

REPLACEMENT OPTICS

- FILM-14-N** Narrow Flood Optic
- FILM-14-F** Flood Optic

INTERCHANGEABLE BEAM OPTIONS:

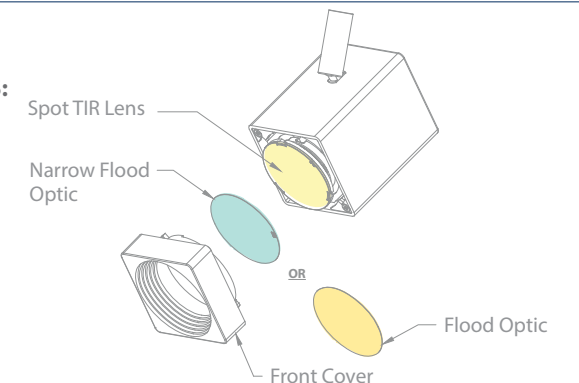

OCULARC 7030



- Integrated 5CCT Switch: 2700K, 3000K, 3500K, 4000K, 5000K
- Integral driver and high output COB LED
- 350° horizontal and 90° vertical aiming
- Accommodates one lens accessory and one glare control accessory
- Three interchangeable beam options included:
 - » 55° beam film pre-installed
 - » 40° film supplied
 - » 20° spot beam, remove all films

Power: 29W
Input: 120V
Comparable to: 100W PAR38
Dimming: 100% - 10% ELV, TRIAC
Rated Life: 50,000 hours

OCULARC 3020W



- Install 3 to 5 feet from wall and 3 to 5 feet on center for optimal effect
- Integrated 5CCT Switch: 2700K, 3000K, 3500K, 4000K, 5000K
- Die-cast aluminum construction
- Powder-coated finishes
- Asymmetrical beam distribution for even wall illumination
- Economical performance luminaire with integral LED and driver

Power: 22W
Input: 120V
Comparable to: 20W HID
Dimming: 100%-10% ELV, TRIAC
Rated Life: 50,000 hours

CCT Selection Switch Onboard



CCT Selection Switch Onboard



System	Model	Color Temp	CRI	Beam	Max Lumens	Max CBCP	Finish
--------	-------	------------	-----	------	------------	----------	--------

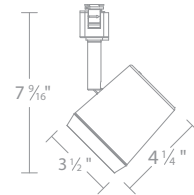

H	H Track						
L	L Track	7030	CS	90	2255	9300	BK Black
J	J/J2 Track				2095	2830	BN Brushed Nickel
					2065	1870	DB Dark Bronze*
							WT White

Example: H-7030-CS-BN

*Only available in H Track

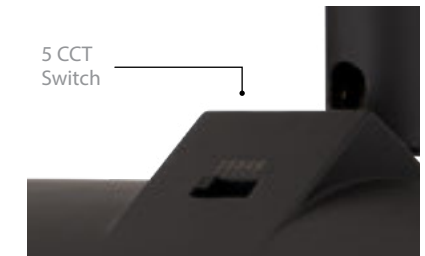

REPLACEMENT OPTICS

- FILM-20-N Narrow Flood Optic
- FILM-20-F Flood Optic

LENS ACCESSORIES

- LENS-20-AMB Amber
- LENS-20-BLU Blue
- LENS-20-GRN Green
- LENS-20-RED Red
- LENS-20-FR Frosted
- LENS-20-SPR Spread
- LENS-20-BEL Beam Elongating

GLARE CONTROL ACCESSORIES

- LENS-20P-CRL-BK
- LENS-20P-CRL-BN
- LENS-20P-CRL-WT
- LENS-20-SNOOT-BK
- LENS-20-SNOOT-BN
- LENS-20-SNOOT-WT
- LENS-20-HCL

INTERCHANGEABLE BEAM OPTIONS:

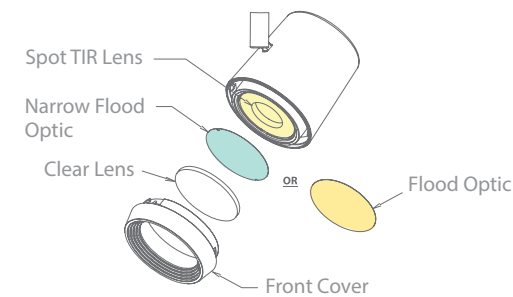

System	Model	Color Temp	CRI	Max Lumens	Finish
--------	-------	------------	-----	------------	--------

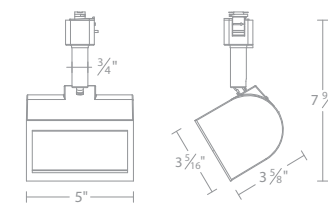

H	H Track				
L	L Track	3020W	CS	90	1150
J	J/J2 Track				

Example: H-3020W-CS-BK

SOLO



Comparable To: 65W MR16
 Input: 120V
 Dimming: 100%-10% ELV, 100%-5% TRIAC
 Rated Life: 50,000 hours

- Available in monopoint, 3-head, or 4-head fixed rail configurations
- Offered in 5" (monopoint), 24", and 36" sizes
- Constructed of die-cast aluminum with a frosted lens
- Suitable for installation on walls or ceilings
- Each head provides 350° horizontal and 90° vertical aiming



	System	Model	Lights	Beam	Max Lumens	CBCP	Wattage	Color Temp	CRI	Finish
	TK	1805	01	45°	800	1095	10W	30 3000K	90	BK Black BN Brushed Nickel WT White
	TK	1805	03	45°	2400 (800 x3)	3285 (1095 x3)	30W	30 3000K	90	BK Black BN Brushed Nickel WT White
	TK	1805	04	45°	3200 (800 x4)	4380 (1095 x4)	40W	30 3000K	90	BK Black BN Brushed Nickel WT White

Example: TK-180503-30-BK

PIPE



Comparable To: 65W MR16
 Input: 120V
 Dimming: 100%-10% ELV, 100%-5% TRIAC
 Rated Life: 50,000 hours

ALL-IN-ONE CCT SELECTABLE



- Available in monopoint, 3-head, or 4-head fixed-rail configurations
- Sizes include 5" for the monopoint and 24" or 36" for multi-head models
- Constructed of die-cast aluminum with a frosted lens
- Suitable for installation on walls or ceilings
- Each head offers 350° horizontal and 90° vertical aiming adjustability

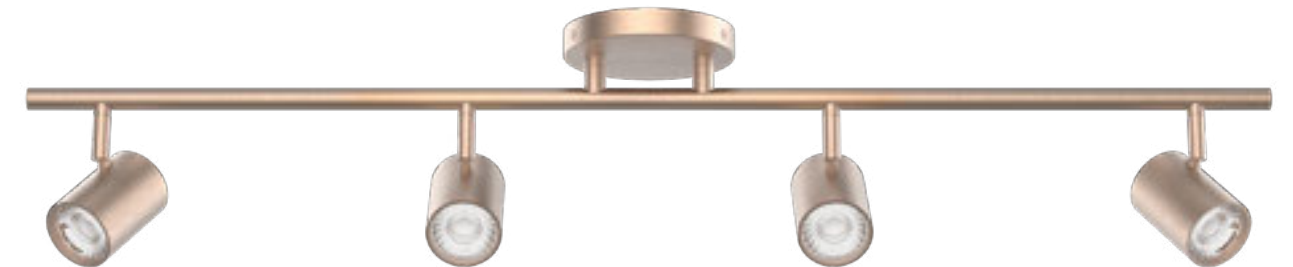

	System	Model	Lights	Beam	Max Lumens	CBCP	Wattage	Color Temp	CRI	Finish
	TK	2605	01	50°	770	805	10W	CS 2700K 3000K 3500K 4000K 5000K	90	BK Black BN Brushed Nickel WT White
	TK	2605	03	50°	2310 (770 x3)	2415 (805 x3)	30W	CS 2700K 3000K 3500K 4000K 5000K	90	BK Black BN Brushed Nickel WT White
	TK	2605	04	50°	3080 (770 x4)	3220 (805 x4)	40W	CS 2700K 3000K 3500K 4000K 5000K	90	BK Black BN Brushed Nickel WT White

Example: TK-260503-CS-BK

CHARGE 8010 & 8020



Input: 120V
 Dimming: 100%-10% ELV, 100%-5% TRIAC
 Rated Life: 50,000 hours

ALL-IN-ONE CCT SELECTABLE



- Suitable for H, J, or L track systems
- Provides 350° horizontal and 90° vertical aiming
- The driver is concealed within the fixture
- Constructed of die-cast aluminum with a frosted lens



H-8010-CS-BN

H-8020-CS-WT

System	Model	Beam	Max Lumens	Max CBCP	Wattage	Color Temp	CRI	Finish
	H HTrack	8010	45°	865	1006	9W	CS	2700K
	L LTrack							3000K
	J J/J2 Track							3500K
								4000K
								5000K
	H HTrack	8010/3	45°	865x3	1006x3	9Wx3	CS	2700K
								3000K
	L LTrack	8020	55°	1330	1154	15W	CS	3500K
	J J/J2 Track							4000K
								5000K

Example: H-8010-CS-BN

SOLO 5010, BULLET 7010, & CYN 8110



Input: 120V
 Dimming: 100%-10% ELV, 100%-5% TRIAC
 Rated Life: 50,000 hours

ALL-IN-ONE CCT SELECTABLE



- Suitable for H, J, or L track systems
- Provides 350° horizontal and 90° vertical aiming
- The driver is concealed within the fixture
- Constructed of die-cast aluminum with a frosted lens



H-5010-CS-BK

H-7010-CS-WT

H-8110-CS-BK

System	Model	Beam	Max Lumens	Max CBCP	Wattage	Color Temp	CRI	Finish
	H HTrack	5010	45°	870	1016	9W	CS	2700K
	L LTrack							3000K
	J J/J2 Track							3500K
								4000K
								5000K
	H HTrack	7010	45°	890	1017	9W	CS	2700K
	L LTrack							3000K
	J J/J2 Track							3500K
								4000K
								5000K
	H HTrack	8110	35°	710	1567	10W	CS	2700K
	L LTrack							3000K
	J J/J2 Track							3500K
								4000K
								5000K

Example: H-5010-CS-BK

J2 / J / L / H TRACK SYSTEM

A variety of 120V rigid track systems that can be used for new construction or retrofitted onto most existing track system installations.

Track luminaires are offered in H, L, J or J2 adapters to specify as needed.

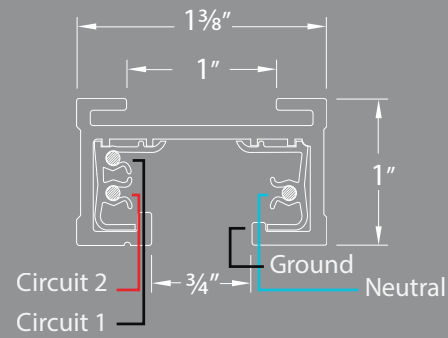

J2 TRACK

Shown in Black

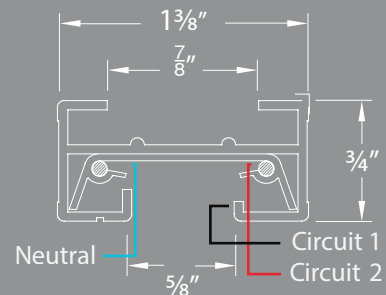

J TRACK

Shown in White

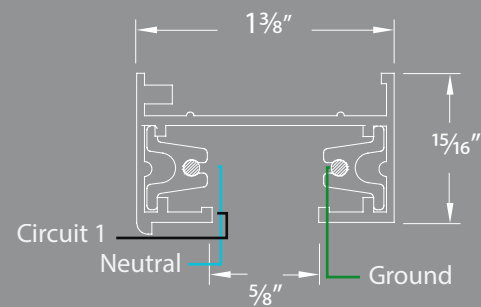

L TRACK

Shown in Brushed Nickel

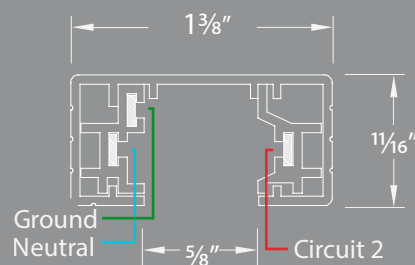

H TRACK

Shown in Dark Bronze



J2 TRACK TWO CIRCUIT TRACK

Description: Two circuit track with independently controllable circuits (shared neutral)
Power Per Circuit: 1920W max
Operating Current: Each circuit is rated 20A (2 x 20A = 40A max)

Saves on installation costs by eliminating the need for long separate feed runs

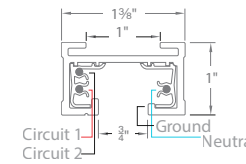

Model	Length	Finish	Description
J2 J2 Track	T4 4'	BK Black	120V 3-wire, wide style track
	T8 8'	WT White	

Example: J2-T8-WT
 Each section includes two matching end caps.

J CLIP

Model	Description
JCLIP	2-Circuit Track Conversion Clip Each 4' section includes 3 Each 8' section includes 6

TRACK SUSPENSION

Model	Length	Finish	Description
SK	18	18"	All Track Suspension Kit Field cuttable.
	24	24"	
	36	36"	
R	18	18"	Suspension Kit Extender
	24	24"	
	36	36"	
	48	48"	
SK14		BK WT	Sloped Ceiling Adapter
RI		BK WT	Rod Coupler
SK05		BK WT	Suspension Adjustment Collar Kit Includes two collars
SKC96		NI	Cable Suspension Suspends track from ceiling. Includes 96" aircraft cable. May be field cut.
J2-SKCF96		BK WT	Cable Suspension Canopy with Feed Canopy covers a standard 4" junction box. Includes 96" of aircraft cable and feed wire. May be field cut.
X	6	6"	Low Voltage Track Head Extension
	12	12"	
	18	18"	
	24	24"	
	36	36"	
TBKT		BK WT	Wall Mount Suspension Bracket
J2-WCOV			Wire Way Cover

ACCESSORIES

Model	Finish	Dimensions	Description
J2-LE	BK WT	4 3/4" x 1 1/4"	Live End Connector
J2-BXLE	BK WT	5 7/8" x 1 3/8"	Live End BX Connector
J2-IPWR	BK WT	7" x 1 3/8"	"I" Power Connector
J2-LLEFT	BK WT	4 1/4" x 4 1/4"	"L" Connector - Left
J2-LRIGHT	BK WT	4 1/4" x 4 1/4"	"L" Connector - Right
J2-T	BK WT	7" x 4 1/4"	"T" Connector
J2-X	BK WT	7" x 7"	"X" Connector
J2-I	BK WT	4 1/2" x 1 3/8"	"I" Connector
J2-IDEC	BK WT	3 1/2" x 1 3/8"	"I" Dead End Connector
J2-FLX	BK WT	1 1/2" x 1 3/8"	Flexible Track Connector
T-BAR-CLIP		1 1/2" x 1 1/4"	T-Bar Drop Ceiling Attachment
J2-UCP	BK WT	4 1/8" x 4 1/8"	Octagon Box Cover
CP-TL	WT	White 4 1/16" x 4 1/16"	Trimless Junction Box Cover
J2-TBLE	BK WT	Black White 4 1/8" x 4 1/8"	T-Bar End Feed

H / J / L TRACK SYSTEM

Description: Single circuit, H, J and L Track
Power Per Circuit: 120V, 1920W max
Operating Current: Rated 20A max

H TRACK

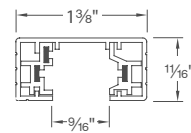

Model	Length	Finish	Description
HT	2'	BK	Black
	4'	BN	Brushed Nickel
	6'	DB*	Dark Bronze
	8'	WT	White

Example: HT6-BK
 Each section includes two matching end caps.

J TRACK

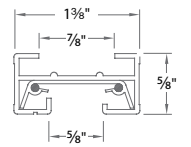

Model	Length	Finish	Description
JT	2'	BK	Black
	4'	BN	Brushed Nickel
	6'	WT	White
	8'		

Example: JT6-BN
 Each section includes two matching end caps.

L TRACK

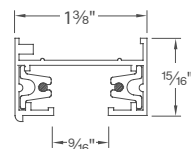

Model	Length	Finish	Description
LT	2'	BK	Black
	4'	BN	Brushed Nickel
	6'	WT	White
	8'		

Example: LT6-WT
 Each section includes two matching end caps.

TRACK SUSPENSION

Model	Length	Finish	Description
SK	18"	BK	Black
	24"	BN	Brushed Nickel
	36"	DB*	Dark Bronze*
	48"	WT	White
R	18"	BK	Black
	24"	BN	Brushed Nickel
	36"	DB*	Dark Bronze*
	48"	WT	White
	72"	WT	White
SK14		BK	Black
		BN	Brushed Nickel
		WT	White
RI		BK	Black
		BN	Brushed Nickel
		WT	White
SK05		BK	Black
		BN	Brushed Nickel
		WT	White
SKC96		NI	Nickel
SKCF96		BK	Black
		WT	White
X	6"		
	12"	BK	Black
	18"	BN	Brushed Nickel
	24"	DB*	Dark Bronze*
	36"	WT	White
H	18"	BK	Black
	24"	BN	Brushed Nickel
	36"	DB*	Dark Bronze*
	48"	WT	White
TBKT		BK	Black
		BN	Brushed Nickel
		WT	White

Example: SK24-BK

ACCESSORIES

Model	Finish	Dimensions	Description
HLE	BK	4 1/4" x 1 3/8" x 3/4"	Live End Connector Use for direct wiring through ceiling. A canopy plate is required when using with a standard junction box.
	BN	4 1/4" x 1 3/8" x 3/4"	
	WT	4 3/4" x 1 1/4" x 3/4"	
HBXLE	BK	5 3/4" x 1 3/8" x 1 1/4"	Live End BX Connector Use with surface mounted BX or non-metallic sheathed cable. Also provides through the ceiling connection.
	BN	6 1/4" x 1 3/8" x 1 1/4"	
	WT	6" x 1 3/8" x 1 1/4"	
HI-PWR	BK	6 3/4" x 1 3/8" x 3/4"	1" Power Connector Power entry point at the connection of 2 tracks.
	BN	7" x 1 3/8" x 3/4"	
	WT	7 1/8" x 1 3/8" x 3/4"	
HL-LEFT	BK	2 3/4" x 2 3/4" x 3/4"	"L" Connector - Left Use to join 2 track sections to make power feedable 90° left polarity turns.
	BN	4 1/4" x 4 1/4" x 3/4"	
	WT	4 1/4" x 4 1/4" x 3/4"	

*DB finish only available for H Track

H / J / L TRACK SYSTEM

ACCESSORIES

Model	Finish	Dimensions	Description
 HL-RIGHT JL-RIGHT LL-RIGHT	BK Black BN Brushed Nickel DB* Dark Bronze* WT White	2 3/4" x 2 3/4" x 3/4" 4 1/4" x 4 1/4" x 3/4" 4 1/4" x 4 1/4" x 3/4"	"L" Connector - Right Use to join 2 track sections to make power feedable 90° right polarity turns.
 HT JT LT	BK Black BN Brushed Nickel DB* Dark Bronze* WT White	4" x 2 3/4" x 3/4" 7 1/4" x 4 1/4" x 3/4" 7 1/8" x 4 1/4" x 3/4"	"T" Connector - Use to join 3 track sections. Power feedable on H and J only. "T" Connector with opposite polarity can be custom ordered.
 HX JX LX	BK Black BN Brushed Nickel DB* Dark Bronze* WT White	4 1/8" x 4 1/8" x 3/4" 7 1/8" x 7 1/8" x 3/4" 7 1/8" x 7 1/8" x 3/4"	"X" Connector Use to join 4 track sections. Power feedable on H and J only.
 HI JI LI	BK Black BN Brushed Nickel DB* Dark Bronze* WT White	3" x 1 3/8" x 3/4" 3 1/8" x 1 3/8" x 3/4" 3" x 1 3/8" x 3/4"	"I" Connector Use to join two sections of track with electrical continuity.
 HI-DEC JI-DEC LI-DEC	BK Black BN Brushed Nickel DB* Dark Bronze* WT White	3" x 1 3/8" x 3/4" 3 1/8" x 1 3/8" x 3/4" 3" x 1 3/8" x 3/4"	"I" Dead End Connector Joins two sections of track without electrical continuity.
 HFLX JFLX LFLX	BK Black BN Brushed Nickel DB* Dark Bronze* WT White	9 3/4" x 1 3/8" x 3/4" 10 1/4" x 1 3/8" x 3/4" 8 1/2" x 1 3/8" x 3/4"	Flexible Track Connector Connects two track sections at variable angles. Use as a transition from wall-to-wall, wall-to-ceiling, or ceiling-to-ceiling. Power feedable.
 H-LOOP J-LOOP L-LOOP	BK Black BN Brushed Nickel DB* Dark Bronze* WT White	1 3/8" x 1 3/8" x 3" 1 3/8" x 1 3/8" x 3" 1 3/8" x 1 3/8" x 3"	Suspension Loop 3 inch electrical loop accepts chain hung fixtures up to 35lbs. Contains compartment for electrical connections.
 HCORD	BK Black WT White	15'	15' Cord, Male Plug Use with H and J. Maximum capacity: 7A, 800W, 120V.
 LCORDSET	BK Black WT White	15'	15' Cord, Male Plug with Switch Use with L. Maximum capacity: 7A, 800W, 120V.
 T-BARCLIP	Chrome	1 1/2" x 1 1/4"	T-Bar Drop Ceiling Attachment Attaches track to T-bar drop ceilings. Use two for 2 foot or 4 foot tracks, three for 6 foot or 8 foot tracks.
 HMP	BK Black BN Brushed Nickel DB* Dark Bronze* WT White	5 3/8" x 5 3/8" Ø 4 3/4" Ø 4 3/8"	Monopoint Canopy Adapter Mount a single H, L or J system track fixture to a junction box. When used with a low voltage track head the transformer box will protrude off of the face of the monopoint.
 JMP LMP	BK Black BN Brushed Nickel DB* Dark Bronze* WT White	4 1/2" x 4 1/2"	Canopy Plate Covers a standard 4 inch junction box. Use with any powerable connectors.
 CP	BK Black BN Brushed Nickel DB* Dark Bronze* WT White	4 1/2" x 4 1/2"	Canopy Plate Covers a standard 4 inch junction box. Use with any powerable connectors.
 CP-TL	WT White	4 1/16" x 4 1/16"	Trimless J-Box Cover Covers a standard 4" square junction box with trimless install for power feeding.
 HFC JFC LFC	BK Black BN Brushed Nickel DB* Dark Bronze* WT White	4 1/2" x 4 1/2" x 1 1/2" 4 1/4" x 4 1/4" x 1 3/8" 4 5/8" x 4 5/8" x 1 3/8"	Floating Canopy Connector - Connects to octagon box. Allows track to be powered anywhere along the length of the track.

*DB finish only available for H Track

H TRACK WATTS PER SQUARE FOOT CURRENT LIMITERS

EXAMPLE INSTALLATION

10' run of H Track in a retail environment with four 11 watt LED fixtures. Actual energy usage: 4 fixtures x 11W = 44W. WAC Lighting Track Current Limiters are designed to address energy allowances.

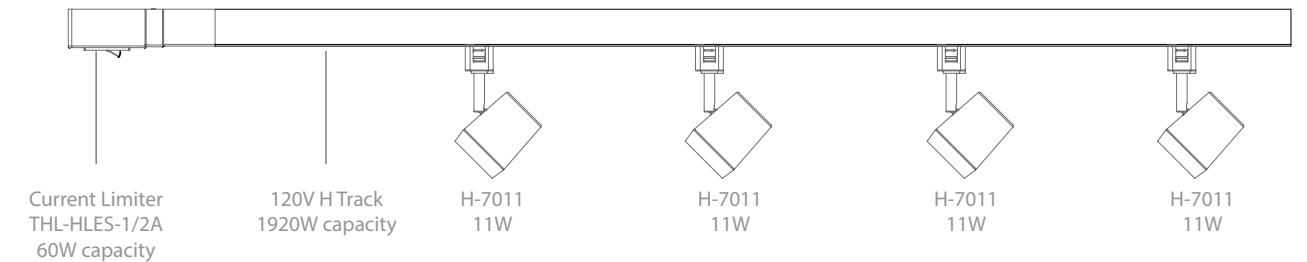

WITHOUT A CURRENT LIMITER

Wattage towards energy allowance

ASHRAE 90.1 and IECC

10 linear ft x 30W = 300W

California's Title 24

10 linear ft x 45W = 450W

WITH A CURRENT LIMITER

Wattage towards energy allowance



ASHRAE 90.1 and IECC

60W current limiter = 60W. Energy allowance saving is 300W - 60W - 24W = 216W

California's Title 24

10 linear ft x 12.5W (per T24 code) = 125W. Energy allowance saving is 450W - 125W = 325W

- If the track is overloaded, the current limiter circuit breaker will trip and shut down power to the circuit
- May be reset when the overall sum of fixture wattages are reduced below the circuit breaker rating

Model	Rating	Circuit Breaker	Max Wattage	Finish	Description
	1/2A	0.5 Amp	60W	BK Black	Slim Single Live End
	1A	1 Amp	120W	BN Brushed Nickel	
	2A	2.5 Amp	300W	DB* Dark Bronze*	
	5A	5 Amp	600W	WT White	
	7A	7.5 Amp	900W		
	1/2A	0.5 Amp	60W	BK Black	Single Live End
	1A	1 Amp	120W	BN Brushed Nickel	
	2A	2.5 Amp	300W	DB* Dark Bronze*	
	5A	5 Amp	600W	WT White	
	7A	7.5 Amp	900W		

Example: THL-HLES-1A-WT

*DB finish only available for H Track

J2 / J / L / H TRACK SYSTEM

DESIGN GUIDELINES

Choose track system: WAC Lighting offers standard systems: L, H and J single circuit track systems and our J2 two circuit system.

Laying Out the Track Design: Determine layout of track and choose appropriate connectors to achieve the look you desire. Mark along the ceiling to indicate the placement of the track.

Power: For direct ceiling mounting, connect to J box using a live end connector in conjunction with a canopy plate. For suspension mounting, connect to J box using a suspension kit canopy. Your maximum load capacity per circuit is 1920W. Determine the total wattage of the fixtures before laying out the remainder of the system.

Mounting: For direct ceiling mounting, screw directly into ceiling. Drop ceiling mounting requires two T-bar clips for 2' or 4' track and three for 6' or 8' track. To suspend track using suspension rods, determine your ceiling type, flat or sloped, and choose appropriate standoffs. Suspension rods are field cuttable to custom length. Cable suspensions option is available in 96" length and are field cuttable. Use two rods or cables for 2' or 4' track and three for 6' or 8' track.

Joining Track Sections: "I" connectors can be either conductive or non conductive. Non-conductive dead end "I" connectors may be used to electrically separate two runs without any visible separation to the design. Other available connectors include an "X" connector, "L" connector, "T" connector, and a flexible track connector.

Useful Tip: Track is supplied with two end caps.

Assistance is only a phone call away. If you need help or design ideas please call WAC Lighting to speak to a friendly technical support specialist at (800) 526-2588.

SAMPLE LAYOUT (EXAMPLE USING L TRACK SYSTEM)

- A SKCF96 96" Cable suspension canopy with feed
- B SKC96 96" Cable suspension
- C LLE Live end connector
- D LT2 2' Section of L Track
- E LL-LEFT "L" Connector (Left)
- F L-7011-CS Ocularc 7011 5-CCT
- G L-ENDCAP End Cap (included with track section)

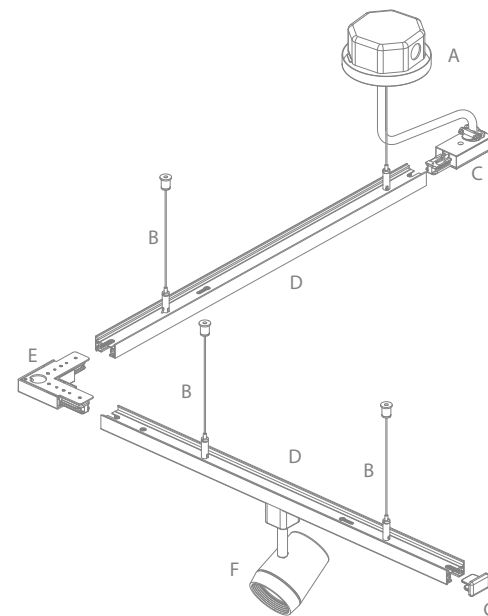

SELECTING CONNECTORS (EXAMPLE USING H TRACK)

In order to select the appropriate connectors to maintain electrical continuity, start at your power source and walk the length of the track. If you turn left, use a left connector. If you turn right, use a right connector.

Polarity is just a matter of matching ends. The 2 wire side of an "H" Track has an indicator groove running its length.

- Using a left connector, the track would run with the groove along the outside.
- Using a right connector, the track would run with the groove along the inside.

— = Indicates Electrical Continuity

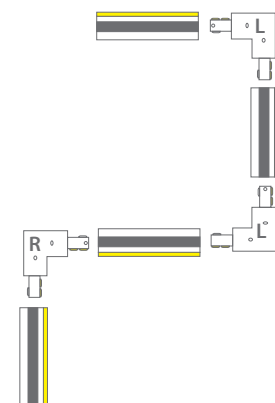
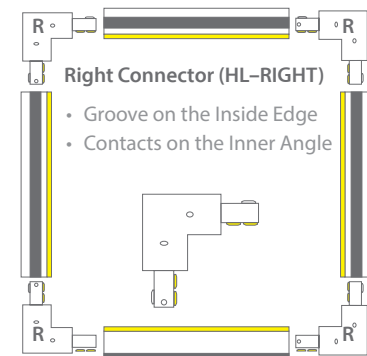
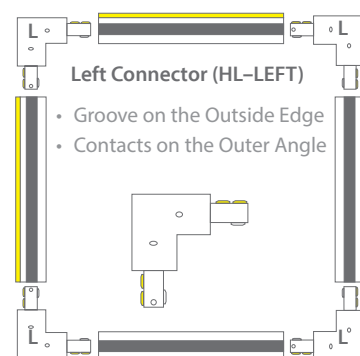

LENS AND ACCESSORIES

COLOR LENS

Model	Finish	Description
LENS-16	AMB	Amber
LENS-20	BLU	Blue
LENS-25	GRN	Green
LENS-30	RED	Red

Changes the color of the light.

UV FILTER

Model	Description
LENS-11-UVF	Protects artwork and delicate fabrics from fading.
LENS-16-UVF	
LENS-20-UVF	
LENS-25-UVF	
LENS-30-UVF	

SPREAD LENS

Model	Description
LENS-11-SPR	Directs the lamp beam to create a diffused light in even pattern.
LENS-16-SPR	
LENS-20-SPR	
LENS-25-SPR	
LENS-30-SPR	

FROSTED LENS

Model	Description
LENS-11-FR	Softens light and reduces glare.
LENS-16-FR	
LENS-20-FR	
LENS-25-FR	
LENS-30-FR	

HONEYCOMB LOUVER

Model	Description
LENS-16-HCL	Shields lamp and reduces glare at a 30° angle.
LENS-20-HCL	
LENS-25-HCL	
LENS-30-HCL	

BEAM ELONGATOR

Model	Description
LENS-11-BEL	Directs the lamp beam to create a horizontal or vertical strip of elongated light.
LENS-16-BEL	
LENS-20-BEL	
LENS-25-BEL	
LENS-30-BEL	

CROSS LOUVER

Model	Finish	Description
LENS-11P-CRL	BK BN WT	Black louver shields lamp and controls spill light and glare; 45° cutoff.
LENS-16P-CRL		
LENS-20P-CRL		
LENS-25P-CRL		

SNOOT

Model	Finish	Description
LENS-11-SNOOT	BK BN WT	Shields lamp and reduces glare.
LENS-16-SNOOT		
LENS-20-SNOOT		
LENS-25-SNOOT		

PAR & BR TRACK LUMINAIRES



178 Universal Medium Base	System	Model	Lamp (Voltage/Wattage)	Finish	Barn Door (order separately)
---------------------------	--------	-------	------------------------	--------	------------------------------



Example: LTK-178-BK *Order lamp separately*

704	System	Model	Lamp	Finish
-----	--------	-------	------	--------

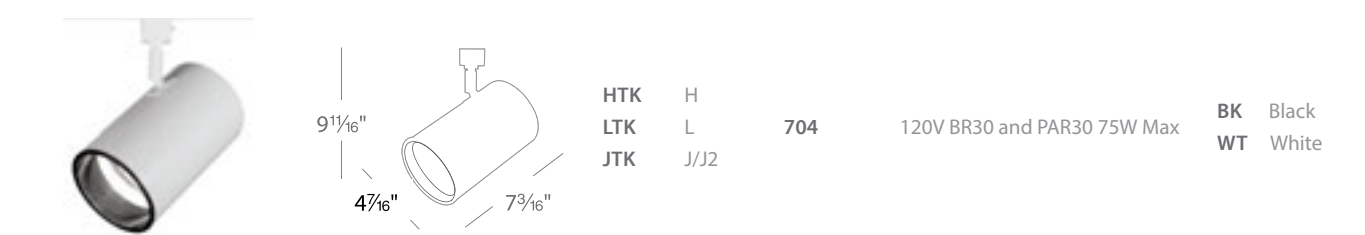

Example: LTK-704-WT *Order lamp separately*

763, 764, 765	System	Model	Lamp (Voltage/Wattage)	Finish
---------------	--------	-------	------------------------	--------

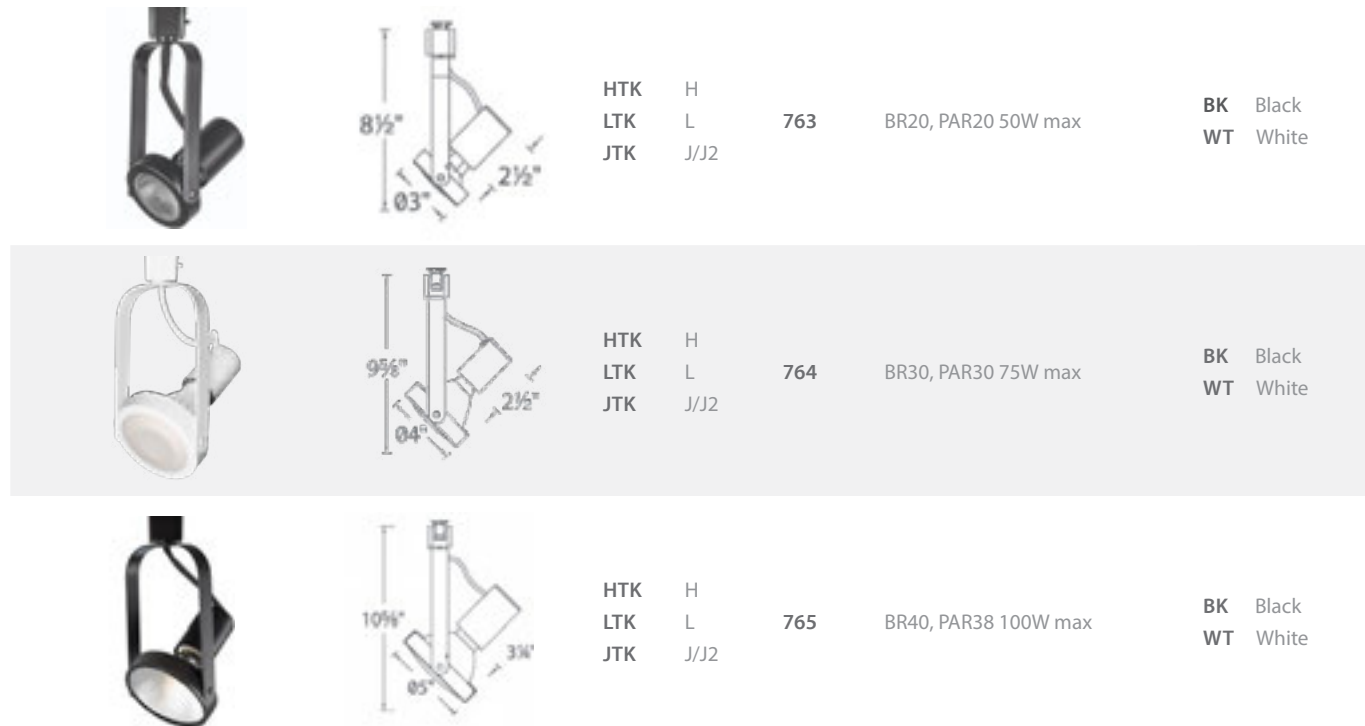

Example: HTK-763-WT *Order lamp separately*

MR16 TRACK LUMINAIRES



809	System	Model	Finish
-----	--------	-------	--------

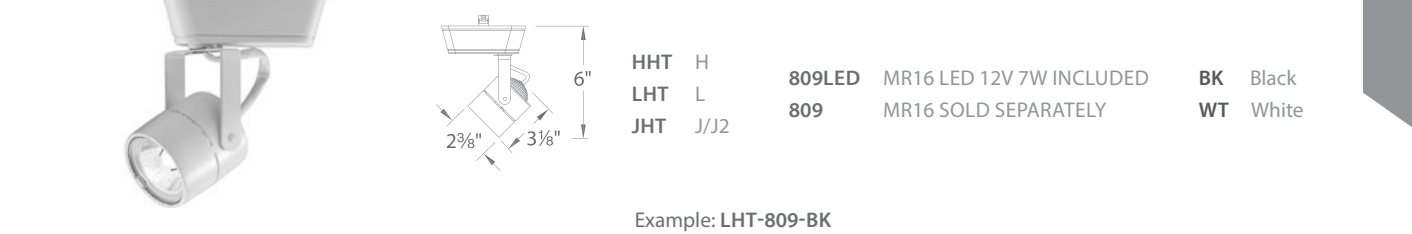

Example: LHT-809-BK

180	System	Lamp (Voltage/Wattage)	Finish
-----	--------	------------------------	--------



Example: LHT-180-BK

808	System	Model	Lamp (Voltage/Wattage)	Finish
-----	--------	-------	------------------------	--------



Example: LHT-808LED-BK

Clear lens included

Available in Monopoint	Model	Lamp	Extension (optional)	CRI	Finish
------------------------	-------	------	----------------------	-----	--------

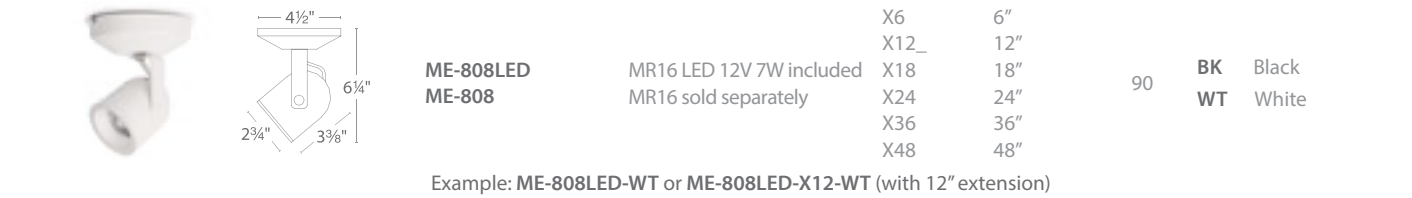

Example: ME-808LED-WT or ME-808LED-X12-WT (with 12" extension)

LED Lamps	Finish	Wattage	Color Temp	Input	Beam	CRI	Lumens	CBCP	Average Life
-----------	--------	---------	------------	-------	------	-----	--------	------	--------------

MR16	Black White	7W	3000K	12V	35°	90	450	850	25,000 Hours
------	----------------	----	-------	-----	-----	----	-----	-----	--------------

Lens Accessories									
------------------	--	--	--	--	--	--	--	--	--

Amber LENS-16-AMB	Blue LENS-16-BLU	Red LENS-16-RED	UV Filter LENS-16-UVF	Beam Elongating LENS-16-BEL
	Green LENS-16-GRN	Frosted LENS-16-FR	Spread LENS-16-SPR	Honeycomb Louver LENS-16-HCL



RECESSED

Clean and unobtrusive, recessed lighting from WAC Lighting integrates seamlessly into ceilings and architectural surfaces. Designed for controlled distribution and visual comfort, these fixtures form the foundation of ambient, task, and accent lighting strategies.

With reliable performance and a low profile presence, recessed solutions support residential and light commercial environments where precision and consistency are essential.

FQ BASIC 2" TRIM



The FQ Basic model features a reduced housing depth, making it a perfect fit for tight ceiling spaces or high-volume projects. Streamlined to focus on core functionality, it still delivers the clean, modern aesthetic and dependable performance that define the FQ family.

Trim Luminaire	Model	Color Temp	Max Lumens (Round/Square)	Max CBCP (Round/Square)	Beam	Finish
	R2FRD1T (Round, Downlight)	927 2700K	1190 / 1195	3185 / 3020	N 25° / F 40° / W 55°	BK Black
		930 3000K	1250 / 1260	3340 / 3180	N 25° / F 40° / W 55°	DB Dark Bronze
		935 3500K	1275 / 1285	3415 / 3240	N 25° / F 40° / W 55°	HZWT Haze/White
	R2FSD1T (Square, Downlight)	WD 3000K - 1800K	965 / 980	1775 / 1620	F 40° / W 55°	WT White
		927 2700K	1105 / 1110	2875 / 2850	N 25° / F 40° / W 55°	BK Black
		930 3000K	1160 / 1170	3025 / 3000	N 25° / F 40° / W 55°	DB Dark Bronze
	R2FRA1T (Round, Adjustable)	935 3500K	1185 / 1190	3085 / 3060	N 25° / F 40° / W 55°	HZWT Haze/White
		WD 3000K - 1800K	855 / 865	1560 / 1575	F 40° / W 55°	WT White
		927 2700K	885 / 865			BK Black
	R2FSA1T (Square, Adjustable)	930 3000K	930 / 910		Asymmetrical	DB Dark Bronze
		935 3500K	950 / 930			HZWT Haze/White
		WD 3000K - 1800K	710 / 675			WT White
	R2FRW1T (Round, Wall Wash)	927 2700K	885 / 865			BK Black
		930 3000K	930 / 910			DB Dark Bronze
		935 3500K	950 / 930			HZWT Haze/White
	R2FSW1T (Square, Wall Wash)	WD 3000K - 1800K	710 / 675			WT White

Example: R2FRD1T-930-HZWT

Accepts one LENS-11 accessory

Trim Remodel Housing	Model	Power	IC / Non-IC	Compatible Trims
	R2FBRT (Round / Square Trim)	1 15W	Non-IC	Downlight, Adjustable, Wall Wash (Static CCT and Dim-to-Warm)
	Example: R2FBRT-1			

Trim New Construction Housing / Frame Kit	Model	Power	IC / Non-IC	Compatible Trims
	R2FBN1T (Round / Square Trim)	1 15W	IC, SPCL*	Downlight, Adjustable, Wall Wash (Static CCT and Dim-to-Warm)
	R2FBN1T (Round / Square Trim)	1-F 15W	IC, SPCL*	Downlight, Adjustable, Wall Wash (Static CCT and Dim-to-Warm) Fire Rated ASTM E119/UL263
	R2FBFT (Round / Square Trim)	1 15W	Non-IC	Downlight, Adjustable, Wall Wash (Static CCT and Dim-to-Warm)
	Example (Fire Rated): R2FBN1T-1-F			*Spray Foam Compatible Luminaire

For additional photometric and power information reference specification sheet.

FQ BASIC 2" TRIMLESS



- Options for downlight, adjustable and wall-wash applications
- IC / airtight housing under 4" tall
- Fire rated housing option
- All optics included for in field swapping
- Accepts one lens or glare control accessory

Trimless Luminaire	Model	Color Temp	Max Lumens (Round/Square)	Max CBCP (Round/Square)	Beam	Finish
	R2FRD1L (Round, Downlight)	927 2700K	1190 / 1195	3185 / 3020	N 25° / F 40° / W 55°	BK Black
		930 3000K	1250 / 1260	3340 / 3180	N 25° / F 40° / W 55°	DB Dark Bronze
		935 3500K	1275 / 1285	3415 / 3240	N 25° / F 40° / W 55°	HZ Haze
	R2FSD1L (Square, Downlight)	WD 3000K - 1800K	965 / 980	1775 / 1620	F 40° / W 55°	WT White
		927 2700K	1105 / 1110	2875 / 2850	N 25° / F 40° / W 55°	BK Black
		930 3000K	1160 / 1170	3025 / 3000	N 25° / F 40° / W 55°	DB Dark Bronze
	R2FRA1L (Round, Adjustable)	935 3500K	1185 / 1190	3085 / 3060	N 25° / F 40° / W 55°	HZ Haze
		WD 3000K - 1800K	855 / 865	1560 / 1575	F 40° / W 55°	WT White
		927 2700K	885 / 865			BK Black
	R2FSA1L (Square, Adjustable)	930 3000K	930 / 910		Asymmetrical	DB Dark Bronze
		935 3500K	950 / 930			HZ Haze
		WD 3000K - 1800K	710 / 675			WT White
	R2FRW1L (Round, Wall Wash)	927 2700K	885 / 865			BK Black
		930 3000K	930 / 910			DB Dark Bronze
		935 3500K	950 / 930			HZ Haze
	R2FSW1L (Square, Wall Wash)	WD 3000K - 1800K	710 / 675			WT White

Example: R2FSW1L-WD-HZ

Accepts one LENS-11 accessory

Trimless Remodel Housing	Model	Power	IC / Non-IC	Compatible Trims
	R2FRRL (Round, Trimless)	1 15W	Non-IC	Downlight, Adjustable, Wall Wash, (Static CCT and Dim-to-Warm)
	R2FSRL (Square, Trimless)			

Trimless New Construction Housing	Model	Power	IC / Non-IC	Compatible Trims
	R2FRN1L (Round, Trimless)	1 15W	IC, SPCL*	Downlight, Adjustable, Wall Wash, (Static CCT and Dim-to-Warm)
	R2FSN1L (Square, Trimless)			
	Example: R2FRN1L-1			*Spray Foam Compatible Luminaire

For additional photometric and power information reference specification sheet.

OCULARC 1.0 LED RECESSED

ART AND ACCENT LIGHTING



- Ships as new construction, adaptable in the field for remodel applications
- Cutout: 2 1/2"
- Single LED module for high-performance illumination without hot spots
- Ceiling thickness: 2"-1"
- Dimming: 100%-5% TRIAC, ELV

Aperture: 1"
 Power: 7.5W
 Input: 120V
 Comparable to: 50W MR16
 Rated Life: 50,000 hours

	Model	Beam	Max Lumens	Max CBCP	Color Temp	CRI	Finish
	R1BRD-08 Round Open Reflector Wet Location	N 25°	670	2397	927 2700K 930 3000K	90	BK Black
		F 45°					BN Brushed Nickel
	R1BRA-08 Round 0-20° Adjustable	N 25°	680	2405	927 2700K 930 3000K	90	BK Black
		F 45°					BN Brushed Nickel
							WT White
							GM Gun Metal
	R1BSD-08 Square Open Reflector Wet Location	N 25°	665	2390	927 2700K 930 3000K	90	BK Black
		F 45°					BN Brushed Nickel
							HZWT Haze/ White
							WT White
	R1BSA-08 Square 0-20° Adjustable	N 25°	680	2405	927 2700K 930 3000K	90	BK Black
		F 45°					BN Brushed Nickel
							WT White
							GM Gun Metal

Example: R1BRD-08-N930-WT

INTEGRAL HOUSING AND TRIM: BOTH NEW CONSTRUCTION & REMODEL

NEW CONSTRUCTION CONFIGURATION

IC Rated Airtight

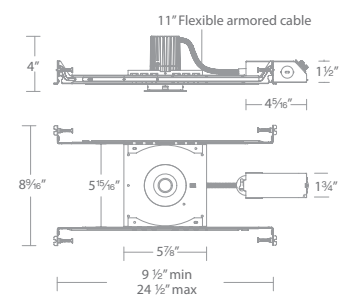

REMODEL CONFIGURATION

IC Rated Airtight

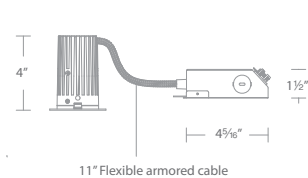

OCULARC 2.0 LED RECESSED

POWERFUL MINIMALISM

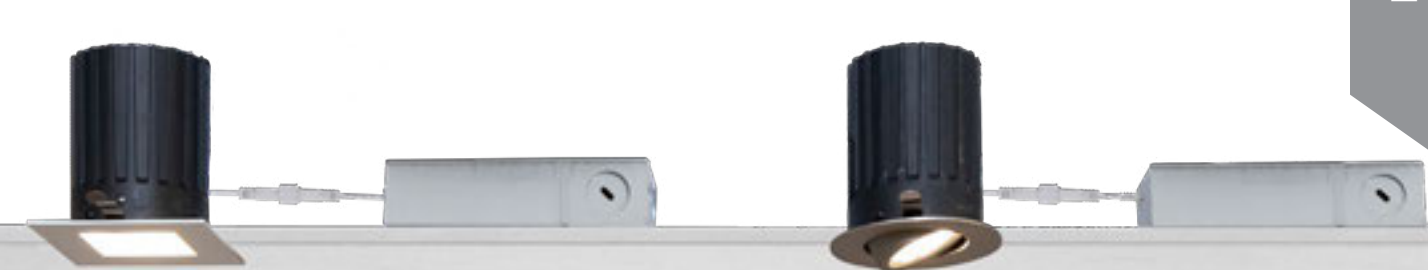

- Ships as new construction, adaptable in the field for remodel applications
- Cutout: 3 1/2"
- Single LED module for high-performance illumination without hot spots
- Ceiling thickness: 2"-1 1/2"
- Dimming: 100%-5% TRIAC, ELV, 0-10V

Aperture: 2"
 Power: 11W/12W
 Input: 120-277V
 Rated Life: 50,000 hours

	Model	Beam	Max Lumens	Max CBCP	Color Temp	CRI	Finish
	R2BRD Round Open Reflector Wet Location	S 18°	955 (12W)	5935	CS 3500K 4000K 5000K	90	BK Black
		N 24°					BN Brushed Nickel
		F 55°					HZWT Haze/ White
							WT White
	R2BRA Round 0-35° Adjustable	S 18°	870 (11W)	5390	CS 3500K 4000K 5000K	90	BK Black
		N 24°					BN Brushed Nickel
		F 55°					WT White
	R2BSD Square Open Reflector Wet Location	S 18°	940 (12W)	6005	CS 3500K 4000K 5000K	90	BK Black
		N 24°					BN Brushed Nickel
		F 55°					HZWT Haze/ White
							WT White
	R2BSA Square 0-35° Adjustable	S 18°	880 (11W)	5515	CS 3500K 4000K 5000K	90	BK Black
		N 24°					BN Brushed Nickel
		F 55°					WT White

Example: R2BRD-SCS-WT

INTEGRAL HOUSING AND TRIM: BOTH NEW CONSTRUCTION & REMODEL

NEW CONSTRUCTION CONFIGURATION

IC Rated Airtight

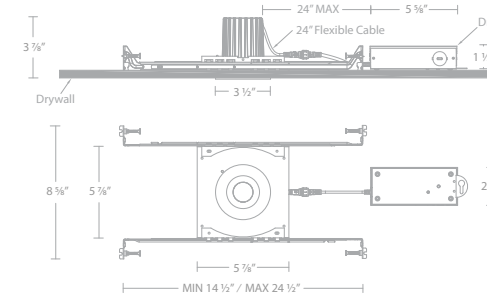

REMODEL CONFIGURATION

IC Rated Airtight

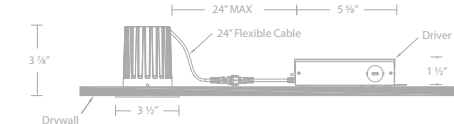

OCULARC 3.0 & OCULARC 3.0 DIM-TO-WARM

THE WORKHORSE



- Ships as new construction, adaptable in the field for remodel applications
- Cutout: 44"
- Single LED module for high-performance illumination without hot spots
- Ceiling thickness: 2"-12"
- Dimming: 100%-5% TRIAC, ELV, 0-10V

Aperture: 3"
Power: 13W
Input: 120-277V
Rated Life: 50,000 hours

	Model	Beam	Max Lumens	Max CBCP	Color Temp	CRI	Finish
	R3BRD Round Open Reflector Wet Location	S Spot	1045	8820	CS	90	BK BN HZWT WT
		N Narrow					
		F Flood					
	R3BRDN		765	3070	WD	95	BK WT
	R3BRDP Polycarbonate Trim Face* Open Reflector	S Spot	1040	8545	CS	90	WT
		N Narrow					
		F Flood					
	R3BRA Round 0-35° Adjustable	S Spot	1060	8925	CS	90	BK BN WT
		N Narrow					
		F Flood					
	R3BRAN		745	2820	WD	95	BK WT
	R3BSD Square Open Reflector Wet Location	S Spot	1040	8510	CS	90	BK BN HZWT WT
		N Narrow					
		F Flood					
	R3BSDN		735	2850	WD	95	BK WT
	R3BSA Square 0-35° Adjustable	S Spot	1070	8905	CS	90	BK BN WT
		N Narrow					
		F Flood					
	R3BSAN		745	2820	WD	95	BK WT

Example: R3BRD-SCS-WT

*Conforms to local code Dead Front requirements

INTEGRAL HOUSING AND TRIM: BOTH NEW CONSTRUCTION & REMODEL

NEW CONSTRUCTION CONFIGURATION

IC Rated Airtight

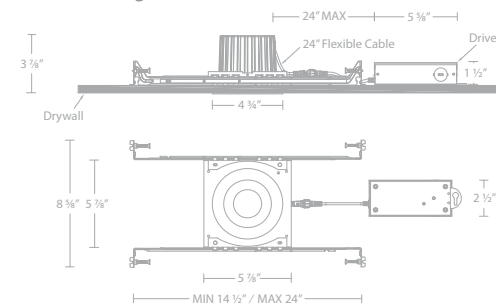

REMODEL CONFIGURATION

IC Rated Airtight

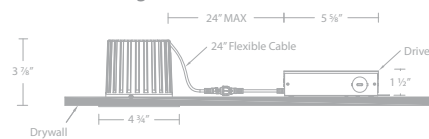

RECESSED



LOTOS

2" ADJUSTABLE LED RECESSED



Input: 120-277V
Dimming: 100%-5% ELV, TRIAC
Rated Life: 50,000 hours



R2ERAR



R2ESAR

- Fixture height measures 2¼", with a driver height of 1¼"
- A 360° retractable pivot enables both fixed downlighting and adjustable aiming
- Heavy-gauge retention clips ensure secure ceiling installation
- Compatible with ceiling thicknesses from ½" to 1½"
- Requires a minimum plenum clearance of 4"
- Constructed from durable steel with a frosted lens for refined light diffusion



R2ESAR-2



R2ESAR-3

	Model	Beam	Wattage	Max Lumens	Max CBCP	Color Temp	CRI	Finish
	R2ERAR 2" Round Adjustable IC Rated, Airtight, Wet Location Listed	W 45°	6W	500	1203	930 3000K	90	WT White
	R2ESAR 2" Square Adjustable IC Rated, Airtight, Wet Location Listed	W 45°	6W	500	1203	930 3000K	90	WT White
	R2ESAR-2 2 Light Adjustable IC Rated, Airtight, Wet Location Listed	W 45°	12W	500x2	1203x2	930 3000K	90	WT White
	R2ESAR-3 3 Light Adjustable IC Rated, Airtight, Wet Location Listed	W 45°	18W	500x3	1203x3	930 3000K	90	WT White

Example: R2ERAR-W930-WT

LOTOS

4" & 6" ADJUSTABLE LED RECESSED



Input: 120-277V
Dimming: 100%-5% ELV, TRIAC
Rated Life: 50,000 hours

ALL-IN-ONE CCT SELECTABLE

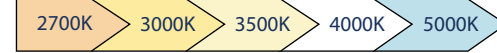

- Fixture height measures 1½", with a driver height of 1¼"
- A 360° retractable pivot enables both fixed downlighting and adjustable aiming
- Heavy-gauge retention clips ensure secure ceiling installation
- Compatible with ceiling thicknesses from ½" to 1½"
- Requires a minimum plenum clearance of 4"
- Constructed from durable steel with a frosted lens for refined light diffusion
- IC rated, airtight, and listed for wet locations



Model	Beam	Wattage	Max Lumens	Max CBCP	Color Temp	CRI	Finish
R4ESAR 4" Square Adjustable	W 45° 9W	9W	750	1050	2700K 3000K 3500K 4000K 5000K	90	WT White
R4ERAR 4" Round Adjustable	W 45° 9W	9W	800	1020	2700K 3000K 3500K 4000K 5000K	90	BK Black WT White
R6ERAR 6" Round Adjustable	W 45° 15W	15W	1340	1896	2700K 3000K 3500K 4000K 5000K	90	BK Black WT White

Example: R4ERAR-W9CS-WT

- Compatible with ceiling thicknesses from ½" to 1½"
- Fire Rated; ASTM E119, UL 263, ULC S101 and tested and certified for 2 hours.
- IC rated, airtight, and listed for wet locations.



Model	Beam	Wattage	Max Lumens	Max CBCP	Color Temp	CRI	Fire Rated	Finish
R4ERAR 4" Round Adjustable	W 45° 9W	9W	800	1020	2700K 3000K 3500K 4000K 5000K	90	F	WT White
R6ERAR 6" Round Adjustable	W 45° 9W	9W	1320	1896	2700K 3000K 3500K 4000K 5000K	90	F	WT White

Example: R6ERAR-W9CS-FWT

New Construction Frame-In Kit (Optional Accessory)	Model	Notes
	RER-FRAME	Suitable for joists ranging from 12" to 24" apart

LOTOS R

4" REGRESSED ADJUSTABLE LED RECESSED



Input: 120-277V
Dimming: 100%-5% ELV, TRIAC
Rated Life: 50,000 hours

ALL-IN-ONE CCT SELECTABLE



- Fixture height measures 1½", with a driver height of 1¼"
- A 360° retractable pivot enables both fixed downlighting and adjustable aiming
- Beam cutoff angle of 15° for defined light control
- Heavy-gauge retention clips ensure secure ceiling installation
- Compatible with ceiling thicknesses from ½" to 1½"
- Requires a minimum plenum clearance of 4"
- Constructed from durable steel with a frosted lens for refined light diffusion
- IC rated, airtight, and listed for wet locations



Model	Beam	Wattage	Max Lumens	Max CBCP	Color Temp	CRI	Finish
R4ERA2R 4" Round Regressed Adjustable	W 50° 9W	9W	775	750	2700K 3000K 3500K 4000K 5000K	90	BK Black WT White

Example: R4ERA2R-W9CS-WT

- Compatible with ceiling thicknesses from ½" to 1½"
- Fire Rated; ASTM E119, UL 263, ULC S101 and tested and certified for 2 hours.
- IC rated, airtight, and listed for wet locations.



Model	Beam	Wattage	Max Lumens	Max CBCP	Color Temp	CRI	Fire Rated	Finish
R4ERA2R 4" Round Regressed Adjustable	W 50° 9W	9W	775	750	2700K 3000K 3500K 4000K 5000K	90	F	WT White

Example: R4ERA2R-W9CS-FWT

New Construction Frame-In Kit (Optional Accessory)	Model	Notes
	RER-FRAME	Suitable for joists ranging from 12" to 24" apart



LOTOS R

6" REGRESSED ADJUSTABLE RETROFIT



Input: 120-277V
Dimming: 100%-5% ELV, TRIAC
Rated Life: 50,000 hours

ALL-IN-ONE CCT SELECTABLE



- Compatible with most standard 6" recessed cans
- A 360° retractable pivot enables both fixed downlighting and adjustable aiming
- Beam cutoff angle of 30° for defined light control
- E26 Edison base adapter included for easy retrofit installation
- Features a maximum tilt angle of 50° for precise directional aiming
- Constructed from durable steel with a frosted lens for refined light diffusion
- IC rated, airtight, and listed for wet locations



Model	Beam	Wattage	Max Lumens	Color Temp	CRI	Finish
R6DRAK 4" Round Regressed Adjustable	A	50°	13W	1270	9CS	2700K
						3000K
						3500K
						4000K
						5000K
	90	BK	Black			
		WT	White			

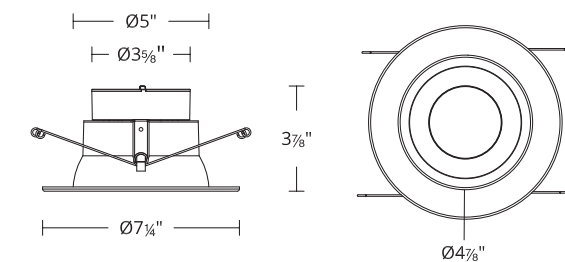

Example: R6DRAK-A9CS-WT

LOTOS

4" & 6" ROUND LED RECESSED





Input: 120-277V
Dimming: 100%-5% ELV, TRIAC
Rated Life: 50,000 hours

ALL-IN-ONE CCT SELECTABLE



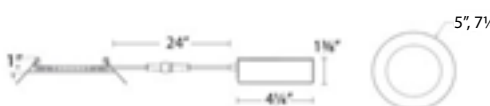

- Fixture height measures 1", with a driver height of 1"
- Heavy-gauge retention clips ensure secure ceiling installation
- Compatible with ceiling thicknesses from 1/2" to 1 1/2"
- Requires a minimum plenum clearance of 4"
- Constructed from durable steel and paired with a translucent diffuser
- IC rated, airtight, and listed for wet locations

Model	Beam	Wattage	Max Lumens	Color Temp	CRI	Finish
 R4ERDR 4" Round Downlight	W	8W	725	2700K	9CS	90 WT White
				3000K		
				3500K		
				4000K		
				5000K		
 R6ERDR 6" Round Downlight	W	14W	1200	2700K	9CS	90 WT White
				3000K		
				3500K		
				4000K		
				5000K		

Example: R4ERDR-W9CS-WT

- Compatible with ceiling thicknesses from 1/2" to 1 3/4"
- Fire Rated; ASTM E119, UL 263, ULC S101 and tested and certified for 2 hours
- IC rated, airtight, and listed for wet locations.



Model	Beam	Wattage	Max Lumens	Color Temp	CRI	Fire Rated	Finish
 R4ERDR 4" Round Downlight	W	8W	725	2700K	9CS	90 F	WT White
				3000K			
				3500K			
				4000K			
				5000K			
 R6ERDR 6" Round Downlight	W	12W	1200	2700K	9CS	90 F	WT White
				3000K			
				3500K			
				4000K			
				5000K			

Example: R4ERDR-W9CS-FWT

New Construction Frame-In Kit (Optional Accessory)	Model	Notes
	RER-FRAME	Suitable for joists ranging from 12" to 24" apart

LOTOS

4" & 6" SQUARE LED RECESSED



Input: 120-277V
Dimming: 100%-5% ELV, TRIAC
Rated Life: 50,000 hours

ALL-IN-ONE CCT SELECTABLE



- Fixture height measures 1", with a driver height of 1"
- Heavy-gauge retention clips ensure secure ceiling installation
- Compatible with ceiling thicknesses from 1/2" to 1 1/2"
- Requires a minimum plenum clearance of 4"
- Constructed from durable steel and paired with a translucent diffuser
- IC rated, airtight, and listed for wet locations

Model	Beam	Wattage	Max Lumens	Color Temp	CRI	Finish
 R4ESDR 4" Square Downlight	W	8W	600	2700K	9CS	90 WT White
				3000K		
				3500K		
				4000K		
				5000K		
 R6ESDR 6" Square Downlight	W	14W	950	2700K	9CS	90 WT White
				3000K		
				3500K		
				4000K		
				5000K		

Example: R4ESDR-W9CS-WT

New Construction Frame-In Kit (Optional Accessory)	Notes
	RER-FRAME Suitable for joists ranging from 12" to 24" apart



KENRIC

3.5" LED RECESSED



Power: 15W
Input: 120-277V
Dimming: 100%-5% ELV, TRIAC and 0-10V
Rated Life: 50,000 hours

- The fixture provides 360° horizontal rotation and 30° vertical tilt for flexible aiming
- A support plate is included for remodel installations
- The low-profile, recessed LED design helps minimize glare
- The housing is constructed from die-cast aluminum with a white powder-coat finish
- A driver is included
- IC rated, airtight, and listed for wet locations



ALL-IN-ONE CCT SELECTABLE



	Model	Beam	Max Lumens	Max CBCP	Color Temp	CRI	Finish
	R3JRAL Round Remodel Downlight/ Adjustable Trimless	W 36°	1450	3430	CS 2700K 3000K 3500K 4000K 5000K	90	WT White
	R3JSAL Square Remodel Downlight/ Adjustable Trimless	W 36°	1420	3425	CS 2700K 3000K 3500K 4000K 5000K	90	WT White
	R3JRAT Round Remodel Downlight/ Adjustable Trim	W 36°	1450	3430	CS 2700K 3000K 3500K 4000K 5000K	90	WT White
	R3JSAT Square Remodel Downlight/ Adjustable Trim	W 36°	1420	3425	CS 2700K 3000K 3500K 4000K 5000K	90	WT White

Example: R3JRAL-WCS-WT

New Construction Frame-In Kit (Optional Accessory)	Model	Notes
	R3JB-FRAME	Ceiling thickness: 1/2" - 1 1/2"

ION

2" LED RECESSED



Power: 9W
Input: 120V-277V
Dimming: 100%-10% ELV, 100%-5% TRIAC
Rated Life: 50,000 hours

- Available for remodel or new-construction applications
- Installs into ceilings ranging from 1/2" to 1 1/2" thick
- Constructed of die-cast aluminum with a frosted lens
- IC-rated, airtight, and listed for wet locations

ALL-IN-ONE CCT SELECTABLE

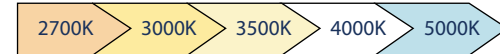

PATRIOT

3" LED RECESSED



Power: 12W
Input: 120-277V
Dimming: 100%-10% ELV, 100%-5% TRIAC
Rated Life: 50,000 hours

- Available for remodel or new-construction applications
- Installs into ceilings ranging from 1/2" to 1 1/2" thick
- Two beam angle options included: a 45° beam film is pre-installed, and removal of the film delivers a 25° narrow beam
- Constructed of die-cast aluminum with an integrated reflector
- IC-rated, airtight, and listed for wet locations

ALL-IN-ONE CCT SELECTABLE



Model	Beam	Max Lumens	Max CBCP	Color Temp	CRI	Finish
 R2DRDR Round Remodel	F	695	2140	2700K	90	WT White
				3000K		
				3500K		
				4000K		
 R2DRDN Round New Construction	30°	695	2140	9CS 3500K	90	WT White
				4000K		
				5000K		
				9CS 3500K		
 R2DSDR Square Remodel	F	695	2140	2700K	90	WT White
				3000K		
				3500K		
				4000K		
 R2DSDN Square New Construction	30°	695	2140	9CS 3500K	90	WT White
				4000K		
				5000K		
				9CS 3500K		

Example: R2DRDR-F9CS-WT

New Construction Frame-In Kit (Optional Accessory)	Model	Notes
--	-------	-------



R2DRDN-FRAME

Ceiling thickness: 1/2" - 1 1/2"

Model	Beam	Max Lumens	Max CBCP	Color Temp	CRI	Finish
 R3HRDR Round Remodel	F	1035	3045	2700K	90	WT White
				3000K		
				3500K		
				4000K		
 R3HRAR Round Adjustable Remodel	F	1000	3095	2700K	90	WT White
				3000K		
				3500K		
				4000K		
 R3HSDR Square Remodel	F	1035	3045	2700K	90	WT White
				3000K		
				3500K		
				4000K		
 R3HSAR Square Adjustable Remodel	F	1000	3095	2700K	90	WT White
				3000K		
				3500K		
				4000K		

Example: R3HRDR-F9CS-WT

New Construction Frame-In Kit (Optional Accessory)	Model	Notes
--	-------	-------



R3H-FRAME

Ceiling thickness: 1/2" - 1 1/2"

POP-IN

4" LED RECESSED



Power: 12W
Input: 120-277V
Dimming: 100%-10% ELV, 100%-5% TRIAC
Rated Life: 50,000 hours



- Electrical wiring box is mounted directly to the back of the fixture for a compact installation
- Available in both remodel and new-construction configurations to suit a variety of applications
- Compatible with ceiling thicknesses from 1/2" to 1 1/2"
- Constructed from die-cast aluminum and paired with a frosted lens
- IC rated, airtight, and listed for wet locations

ALL-IN-ONE CCT SELECTABLE

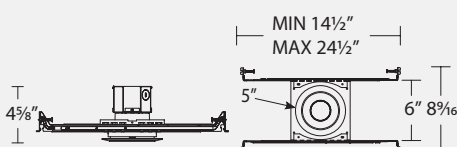
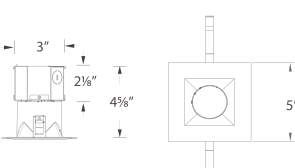
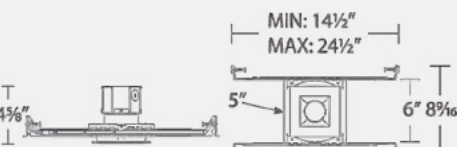

Model	Beam	Max Lumens	Max CBCP	Color Temp	CRI	Finish
 R4DRDR Round Remodel	F 45°	1080	1309	9CS 2700K 3000K 3500K 4000K 5000K	90	BK WT Black White
 R4DRDN Round New Construction	F 45°	1080	1309	9CS 2700K 3000K 3500K 4000K 5000K	90	BK WT Black White
 R4SDR Square Remodel	F 45°	1000	1256	9CS 2700K 3000K 3500K 4000K 5000K	90	BK WT Black White
 R4SDN Square New Construction	F 45°	1000	1256	9CS 2700K 3000K 3500K 4000K 5000K	90	BK WT Black White

Example: R4DRDR-F9CS-WT

New Construction Frame-In Kit (Optional Accessory)	Model	Notes
	R4DRDN-FRAME	Ceiling thickness: 1/2" - 1 1/2"

POP-IN

4" LED RECESSED



Power: 12W
Input: 120-277V
Dimming: 100%-10% ELV, 100%-5% TRIAC
Rated Life: 50,000 hours



- Features a remote driver, ideal for shallow plenum spaces and restricted ceiling conditions
- Available in both remodel and new-construction configurations to suit a variety of applications
- Compatible with ceiling thicknesses from 1/2" to 1 1/2"
- Constructed from die-cast aluminum and paired with a frosted lens
- IC rated, airtight, and listed for wet locations

ALL-IN-ONE CCT SELECTABLE

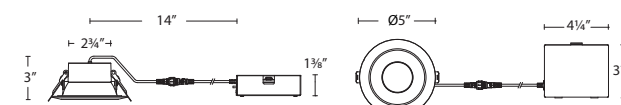
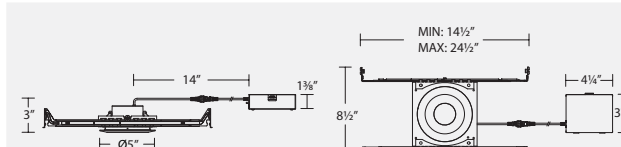
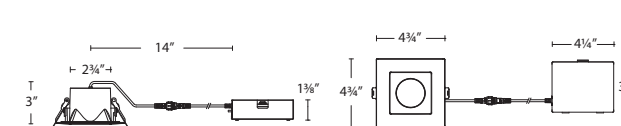
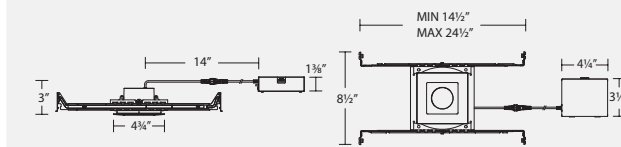

Model	Beam	Max Lumens	Max CBCP	Color Temp	CRI	Finish
 R4DRDR2 Round Remodel	F 45°	1000	1093	9CS 2700K 3000K 3500K 4000K 5000K	90	BK WT Black White
 R4DRDN2 Round New Construction	F 45°	1000	1093	9CS 2700K 3000K 3500K 4000K 5000K	90	BK WT Black White
 R4SDR2 Square Remodel	F 45°	935	1096	9CS 2700K 3000K 3500K 4000K 5000K	90	BK WT Black White
 R4SDN2 Square New Construction	F 45°	935	1096	9CS 2700K 3000K 3500K 4000K 5000K	90	BK WT Black White

Example: R4DRDR2-F9CS-WT



New Construction Frame-In Kit (Optional Accessory)	Model	Notes
	R4DRDN-FRAME	Ceiling thickness: 1/2" - 1 1/2"

2.5" LOW VOLTAGE

MR16 RECESSED

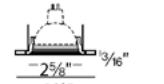

- Transformers require a minimum load of 1 watt
- Non-IC housings require 3" of clearance from insulation on all sides
- Accommodates ceiling thicknesses up to 3/4" for both remodel and new-construction installations

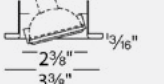
2.5" trims (Order Housing Separately)	Model	Finish	Baffle/Trim
 	HR-836 HR-836LED Metal Trim	BN WT	Brushed Nickel White/White
 	HR-837 HR-837LED Gimbal Ring, 25° Adjustment from Vertical	BK BN WT	Black Brushed Nickel White

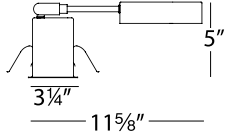
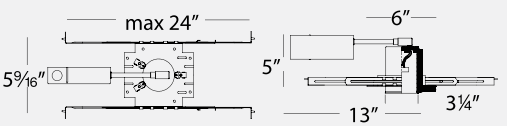
2.5" Housings (Required)	Model	Input	Transformer	Output	Type
	HR-801	120V	Electronic	12V, 50W max 1W min	Remodel Non-IC
	HR-802	120V	Electronic	12V, 50W max 1W min	New Construction Non-IC







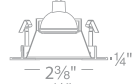

Non-IC housings require 3" of clearance from insulation on all sides.

4" LOW VOLTAGE

MR16 RECESSED

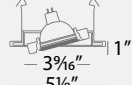

- 4" Low Voltage accommodates most LED MR16 lamps
- Features durable die-cast aluminum construction
- Steel spring clips securely fasten the trim to the housing
- The finish is an abrasion-resistant powder coat or plated metal, designed for long-lasting performance

4" Downlight Trims (Order Housing Separately)	Model	Input	Finish	Description
 	Square open reflector HR-D412-S MR16 sold separately HR-D412LED-S LED MR16 included	MR16, 50W max	SC/BN SC/WT	Specular/Brushed Nickel Specular/White
 	Round open reflector HR-D412 MR16 sold separately HR-D412LED LED MR16 included	35° adjustment from vertical, MR16, 50W max	SC/BN SC/WT	Specular/Brushed Nickel Specular/White
 	Step baffle HR-D411 MR16 sold separately HR-D411LED LED MR16 included	35° adjustment from vertical, MR16, 50W max	WT/WT	White Baffle/White
 	Gimbal ring HR-D417 MR16 sold separately HR-D417LED LED MR16 included	25° adjustment from vertical, MR16, 50W max	BN WT	Brushed Nickel White
 	Directional spot HR-D425 MR16 sold separately HR-D425LED LED MR16 included	80° adjustment from vertical, MR16, 50W max	WT	White

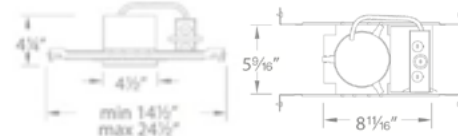
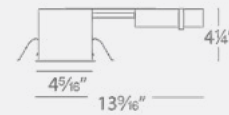
4" Low Voltage Housings (Required)	Model	Input	Transformer	Output	Type
	HR-8402E	120V	Electronic	12V, 50W max 1W min	New Construction Non-IC
	HR-8401E	120V	Electronic	12V, 50W max 1W min	Remodel Non-IC

Non-IC housings require 3" of clearance from insulation on all sides. Accommodates ceiling thickness of up to 3/4" for remodel and new construction.



DECORATIVE

Decorative lighting from WAC Lighting introduces visual character while contributing to the overall lighting composition of a space. Often serving as a focal element, these fixtures support ambient and accent layers while reinforcing architectural and interior design intent.

Available in a range of forms and styles, decorative solutions allow designers and installers to balance aesthetics with performance across residential and light commercial applications.



TWIST-N-LITE

LUMINAIRE SYSTEM



Input: 120V
Dimming: 100%-10% ELV, 100%-5% TRIAC
Rated Life: 50,000 hours

- This fixture installs over a 3", 4", or combination 3/0-4/0 electrical box
- Constructed of aluminum with a translucent acrylic diffuser
- A shared canopy design allows fixtures to be swapped without adjusting the mounting hardware
- All wiring and connections are completed in the junction box before installing the mounting base and canopy

ALL-IN-ONE CCT SELECTABLE

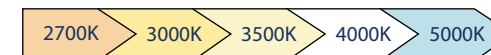

Twist-N-Lite Mini Flush Mount	Model	Wattage	Max Lumens	Color Temp	CRI	Finish
-------------------------------	-------	---------	------------	------------	-----	--------

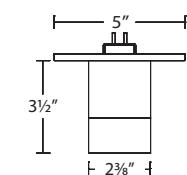

FM-240103	12W	900	CS	2700K	90	BK Black BN Brushed Nickel WT White
				3000K		
				3500K		
				4000K		
				5000K		

The Twist-N-Lite mini flush mount features a 45° flood beam angle.

Example: FM-240103-CS-WT

Twist-N-Lite Mini Flush Mount	Model	Wattage	Max Lumens	Color Temp	CRI	Finish
-------------------------------	-------	---------	------------	------------	-----	--------

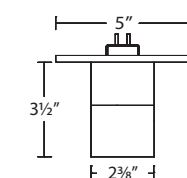

FM-240203	9W	550	CS	2700K	90	BK Black BN Brushed Nickel WT White
				3000K		
				3500K		
				4000K		
				5000K		

This mini flush mount features a dual-layer acrylic diffuser that delivers a frosted, uniformly even glow.

Example: FM-240203-CS-BK

Twist-N-Lite Pendant	Model	Wattage	Max Lumens	Color Temp	CRI	Finish
----------------------	-------	---------	------------	------------	-----	--------

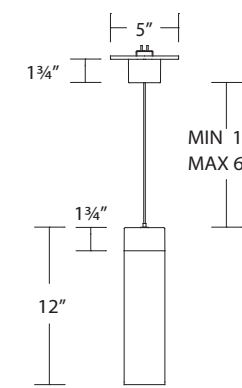

PD-240212	13W	900	CS	2700K	90	BK Black BN Brushed Nickel WT White
				3000K		
				3500K		
				4000K		
				5000K		

Example: PD-240212-CS-BK

The Twist-N-Lite pendant allows tool-free cable adjustment by pressing the cable gripper. Dual-layer acrylic delivers a frosted, even aesthetic.

TWIST-N-LITE LUMINAIRE SYSTEM

Quick and convenient. Easy to use and easy to install, our Twist-N-Lite system offers a variety of surface mounts and pendant luminaires in five color temperatures and three finishes.

The universal mounting base accommodates our complete suite of Twist-N-Lite products. The flexible design enables you to interchange the fixtures in the field to meet your various lighting applications. This energy-efficient engineering wonder offers dimmable options for high performance and a classic, minimalistic aesthetic.

Select your color temperature. Twist it in. Turn it on.

Elevating multifunctional illumination to a higher standard.

Quick Install

Mount and power any fixture in the Twist-N-Lite family by twisting it onto the canopy.



TWIST-N-LITE

LUMINAIRE SYSTEM



ALL-IN-ONE CCT SELECTABLE

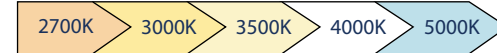

Twist-N-Lite Flush Mount	Model	Wattage	Max Lumens	Color Temp	CRI	Finish
--------------------------	-------	---------	------------	------------	-----	--------

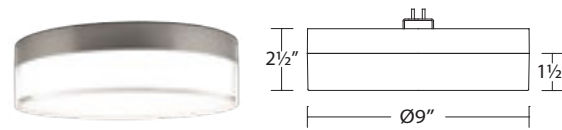

FM-240209 22W 1500 CS	2700K	90	BK Black BN Brushed Nickel WT White
	3000K		
	3500K		
	4000K		
	5000K		

The Twist-N-Lite flush mount features dual-layer acrylic for a frosted and even look.

Example: FM-240209-CS-BN

Twist-N-Lite Indirect Semi-Flush	Model	Wattage	Max Lumens	Color Temp	CRI	Finish
----------------------------------	-------	---------	------------	------------	-----	--------

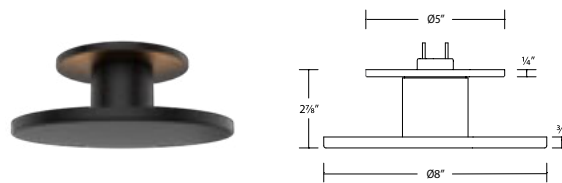

FM-250708 10W 720 CS	2700K	90	BK Black BN Brushed Nickel WT White
	3000K		
	3500K		
	4000K		
	5000K		

Example: FM-250708-CS-BK

Twist-N-Lite 8" Direct Semi-Flush	Model	Wattage	Max Lumens	Color Temp	CRI	Finish
-----------------------------------	-------	---------	------------	------------	-----	--------

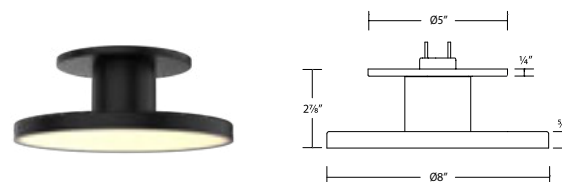

FM-250808 14W 800 CS	2700K	90	BK Black BN Brushed Nickel WT White
	3000K		
	3500K		
	4000K		
	5000K		

Example: FM-250808-CS-BK

Twist-N-Lite 11" Direct Semi-Flush	Model	Wattage	Max Lumens	Color Temp	CRI	Finish
------------------------------------	-------	---------	------------	------------	-----	--------

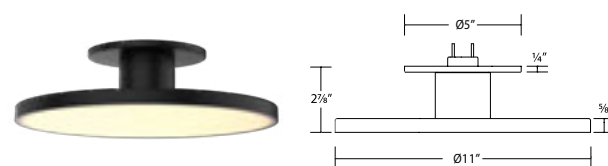

FM-250811 19W 1200 CS	2700K	90	BK Black BN Brushed Nickel WT White
	3000K		
	3500K		
	4000K		
	5000K		

Example: FM-250811-CS-BK

TWIST-N-LITE

LUMINAIRE SYSTEM



ALL-IN-ONE CCT SELECTABLE

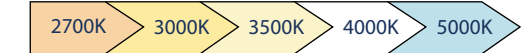

Twist-N-Lite Flush Mount	Model	Wattage	Max Lumens	Color Temp	CRI	Finish
--------------------------	-------	---------	------------	------------	-----	--------

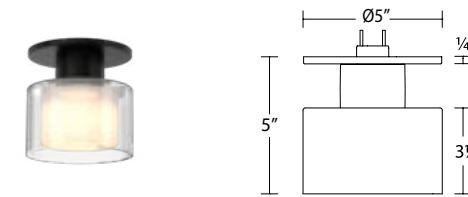

FM-250905 10W 660 CS	2700K	90	BK Black BN Brushed Nickel WT White
	3000K		
	3500K		
	4000K		
	5000K		

Example: FM-250905-CS-BK

Twist-N-Lite Pendant	Model	Wattage	Max Lumens	Color Temp	CRI	Finish
----------------------	-------	---------	------------	------------	-----	--------

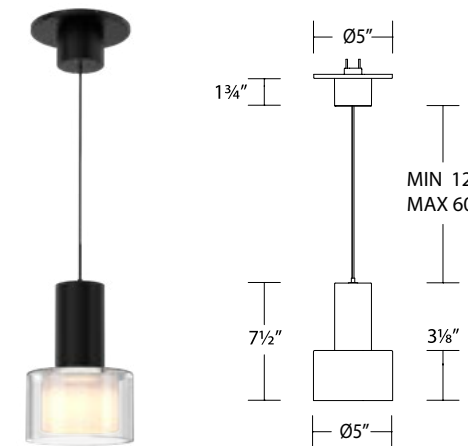

PD-250905 12W 850 CS	2700K	90	BK Black BN Brushed Nickel WT White
	3000K		
	3500K		
	4000K		
	5000K		

Example: PD-250905-CS-BK

Twist-N-Lite Pendant	Model	Wattage	Max Lumens	Color Temp	CRI	Finish
----------------------	-------	---------	------------	------------	-----	--------

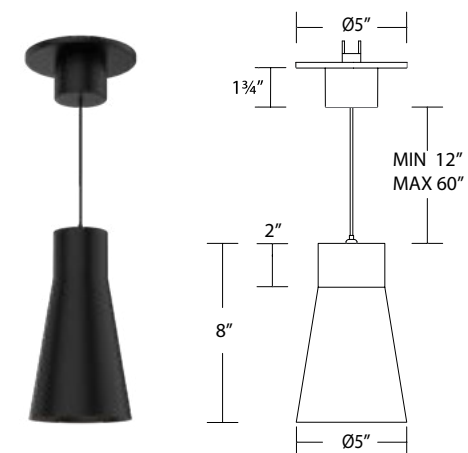

PD-251005 12W 880 CS	2700K	90	BK Black BN Brushed Nickel WT White
	3000K		
	3500K		
	4000K		
	5000K		

Example: PD-251005-CS-BK



EDGELESS

FLUSH MOUNT



Input: 120V
Dimming: 100%-10% ELV, 100%-5% TRIAC
Rated Life: 50,000 hours

ALL-IN-ONE CCT SELECTABLE



- Available in 5", 8", and 12" sizes
- Installs into a 3", 4", or combination 3/0-4/0 electrical box
- Constructed of aluminum with a translucent diffuser



5"
FM-240505



8"
FM-240508



12"
FM-240512

Edgeless	Model	Wattage	Max Lumens	Color Temp	CRI	Finish
	FM-240505	15W	1330	2700K 3000K 3500K 4000K 5000K	90	BK Black WT White
	FM-240508	20W	1985	2700K 3000K 3500K 4000K 5000K	90	BK Black WT White
	FM-240512	30W	2750	2700K 3000K 3500K 4000K 5000K	90	BK Black WT White

Example: FM-240508-9CS-WT

I CAN'T BELIEVE IT'S NOT RECESSED



Input: 120V
Dimming: 100%-10% ELV, 100%-5% TRIAC
Rated Life: 50,000 hours

ALL-IN-ONE CCT SELECTABLE



- This fixture imitates the look of a traditional 6" line-voltage recessed downlight using an R30-style light source
- Installs into a 4" junction box or a combination 3/0-4/0 electrical box
- Constructed of aluminum with a translucent diffuser
- Finished screw caps are included to eliminate shadows

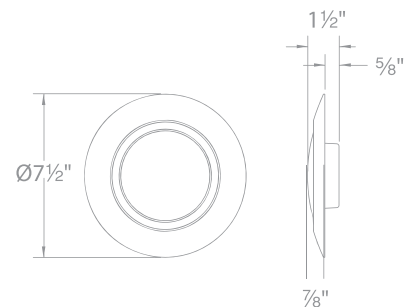

Model	Max Lumens	Power	Color Temp	CRI	Finish
FM-616G2	1050	16W	2700K	90	WT White
			3000K		
			3500K		
			4000K		
			5000K		

Example: FM-616G2-9CS-WT

DISC

LED CEILING LIGHT & RECESSED RETROFIT



Input: 120V
Dimming: 100%-10% ELV, 100%-5% TRIAC
Rated Life: 50,000 hours

- FM-306MS features an integrated motion sensor that keeps the fixture illuminated for three minutes and automatically turns it off if no movement is detected
- Constructed of aluminum with a translucent diffuser



FM-306-9CS-WT



FM-306MS-930JB-WT

	Model	Max Lumens	Wattage	Color Temp	CRI	Finish	Description
	FM-304	725	12W	930 3000K	90	WT White	Fits over a 4" recessed can or direct wire in a 3" or 4" junction box or pancake box
	FM-306	950	15W	9CS 2700K, 3000K, 3500K, 4000K, 5000K	90	WT White	Fits over a 5" to 6" recessed can or direct wire in a 3" or 4" junction box or pancake box
	FM-306MS Infrared Motion Sensor	1100	14W	930JB 3000K	90	WT White	Direct mount on a 3" or 4" junction box or pancake box
	FM-309	1725	23W	9CSJB 2700K, 3000K, 3500K, 4000K, 5000K	90	WT White	Direct mount on a 3" or 4" junction box or pancake box

Example: FM-306-9CS-WT



BLO • FLO • GLO



ALL-IN-ONE CCT SELECTABLE



BLO



Input: 120-277V
Dimming: 100%-10% ELV, 100%-5% TRIAC
Rated Life: 50,000 hours

- Installs over a 3", 4", or combination 3/0-4/0 electrical box for flexible mounting
- Constructed from aluminum with a translucent acrylic diffuser for smooth, even illumination

Blo	Model	Max Lumens	Wattage	Color Temp	CRI	Finish
	FM-113	1600	22W	CS 2700K 3000K 3500K 4000K 5000K	90	WT White
	FM-115	2230	26W	CS 2700K 3000K 3500K 4000K 5000K	90	WT White

Example: FM-113-CS-WT

FLO



Input: 120-277V
Dimming: 100%-10% ELV, 100%-5% TRIAC
Rated Life: 50,000 hours

- Available in 24", 36", and 48" sizes
- Suitable for both wall and ceiling installations
- Constructed from aluminum with a translucent acrylic diffuser for uniform illumination

Flo	Model	Max Lumens	Wattage	Color Temp	CRI	Finish
	WS-224	1400	17W	CS 2700K 3000K 3500K 4000K 5000K	90	WT White
	WS-236	2250	28W	CS 2700K 3000K 3500K 4000K 5000K	90	WT White
	WS-248	2630	32W	CS 2700K 3000K 3500K 4000K 5000K	90	WT White

Example: WS-248-CS-WT

GLO



Input: 120-277V
Dimming: 100%-10% ELV, 100%-5% TRIAC
Rated Life: 50,000 hours

- Installs over a 3", 4", or combination 3/0-4/0 electrical box for flexible mounting
- Constructed from aluminum with a translucent acrylic diffuser for smooth, even illumination

Glo	Model	Max Lumens	Wattage	Color Temp	CRI	Finish
	FM-211	1160	15W	CS 2700K 3000K 3500K 4000K 5000K	90	WT White
	FM-214	1660	22W	CS 2700K 3000K 3500K 4000K 5000K	90	WT White
	FM-216	2300	26W	CS 2700K 3000K 3500K 4000K 5000K	90	WT White

Example: FM-211-CS-WT

LITHIUM

EM BATTERY BACKUP



Input: 120-277V
Dimming: 100%-10% ELV, 100%-5% TRIAC
Rated Life: 50,000 hours

ALL-IN-ONE CCT SELECTABLE



- During emergency mode, the fixture remains illuminated for 90 minutes at reduced power
- Installs over a 3", 4", or combination 3/0-4/0 electrical box
- Constructed of aluminum with a translucent diffuser

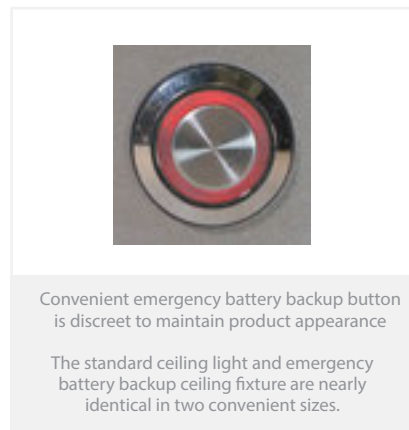

FM-200115-CS-BN



FM-200118-CS-BN

	Model	Wattage	Max Lumens	Color Temp	CRI	Finish
	FM-200115	25W	1815	2700K	90	BN
				3000K		
				3500K		
				4000K		
				5000K		
	FM-200118	31W	2410	2700K	90	BN
				3000K		
				3500K		
				4000K		
				5000K		

Example: FM-200115-CS-BN



CEILING MOUNT

ROUND & SQUARE

LED CEILING & WALL MOUNT



Input: 120V-277V
Dimming: 100%-10% ELV, 100%-5% TRIAC
Rated Life: 50,000 hours

- Installs into a 3", 4", or combination 3/0-4/0 electrical box
- Constructed of injection-molded, UV-rated PC with a translucent diffuser
- Suitable for outdoor and coastal environments



5" Round & Square	Model	Wattage	Max Lumens	Color Temp	CRI	Finish
	FM-05RN Round	12W	1050	930 3000K 935 3500K	90	BK Black BZ Bronze NI Nickel WT White
	FM-05SQ Square	12W	1030	930 3000K 935 3500K	90	BZ Bronze WT White

Example: FM-05RN-930-WT

ROUND & SQUARE

LED CEILING & WALL MOUNT



Input: 120V
Dimming: 100%-10% ELV, 100%-5% TRIAC
Rated Life: 50,000 hours

- Installs into a 3", 4", or combination 3/0-4/0 electrical box
- Constructed of aluminum with a translucent diffuser



7", 11", 15" Round & 7" & 11" Square	Model	Max Lumens	Wattage	Color Temp	CRI	Finish
	FM-07RN Round	1100	15W	930 3000K 935 3500K	90	BK Black BN Brushed Nickel BZ Bronze WT White
	FM-11RN Round	1525	20W	930 3000K 935 3500K	90	BK Black BN Brushed Nickel BZ Bronze WT White
	FM-15RN Round	2550	28W	930 3000K 935 3500K	90	BK Black BN Brushed Nickel BZ Bronze WT White
	FM-07SQ Square	1100	15W	930 3000K 935 3500K	90	BN Brushed Nickel BZ Bronze WT White
	FM-11SQ Square	1650	20W	930 3000K 935 3500K	90	BN Brushed Nickel BZ Bronze WT White

Example: FM-15RN-930-WT

ROUND

24" LED CEILING & WALL MOUNT



Input: 120V
Dimming: 100%-10% ELV, 100%-5% TRIAC
Rated Life: 50,000 hours

ALL-IN-ONE CCT SELECTABLE



- The fixture has a height of 1"
- Installs into a 3", 4", or combination 3/0-4/0 electrical box
- Constructed of aluminum with an acrylic diffuser

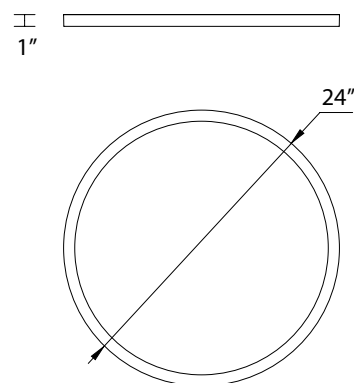

Model	Max Lumens	Wattage	Color Temp	CRI	Finish
FM-252124	3100	45W	CS 2700K 3000K 3500K 4000K 5000K	90	BK Black BZ Bronze WT White

Example: FM-252124-CS-BK

DEW

18" LED CEILING & WALL MOUNT



Input: 120V
Dimming: 100%-10% ELV, 100%-5% TRIAC
Rated Life: 50,000 hours

ALL-IN-ONE CCT SELECTABLE



- The fixture has a height of 4 1/4"
- Installs into a 3", 4", or combination 3/0-4/0 electrical box
- Constructed of aluminum with an acrylic diffuser

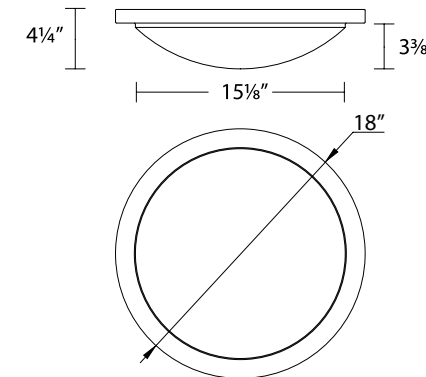

Model	Max Lumens	Wattage	Color Temp	CRI	Finish
FM-252218	3050	45W	CS 2700K 3000K 3500K 4000K 5000K	90	BK Black BZ Bronze WT White

Example: FM-252218-CS-WT

METRO

LED CEILING & WALL MOUNT



Input: 120-277V
Dimming: 100%-10% ELV, 100%-5% TRIAC
Rated Life: 50,000 hours

- Flush mount available in two sizes: 12" and 18"
- Flush mount fixture height: 1 3/4"
- Flush mount installs easily into a 3", 4", or combination 3/0-4/0 electrical box
- Wall sconce available in three sizes: 20", 27", and 37"
- Wall sconce mounts vertically or horizontally for design flexibility
- Constructed from aluminum with a dual-layer acrylic diffuser for even, elegant illumination



Metro Flush Mount	Model	Max Lumens	Wattage	Color Temp	CRI	Finish
-------------------	-------	------------	---------	------------	-----	--------



FM-180112	1800	24W	30	3000K	90	BN CH	Brushed Nickel Chrome
-----------	------	-----	----	-------	----	----------	--------------------------



FM-180118	2375	32W	30	3000K	90	BN CH	Brushed Nickel Chrome
-----------	------	-----	----	-------	----	----------	--------------------------

Example: FM-180118-30-BN

Metro Wall Sconce	Model	Max Lumens	Wattage	Color Temp	CRI	Finish
-------------------	-------	------------	---------	------------	-----	--------

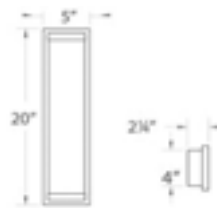

WS-180120	1150	16W	30	3000K	90	BN CH	Brushed Nickel Chrome
-----------	------	-----	----	-------	----	----------	--------------------------



WS-180127	1450	20W	30	3000K	90	BN CH	Brushed Nickel Chrome
-----------	------	-----	----	-------	----	----------	--------------------------



WS-180137	2130	28W	30	3000K	90	BN CH	Brushed Nickel Chrome
-----------	------	-----	----	-------	----	----------	--------------------------

Example: WS-180127-30-BN

FUSE

LED WALL OR CEILING MOUNT



Input: 120V-277V
Dimming: 100%-10% ELV, 100%-5% TRIAC
Rated Life: 50,000 hours

- Available in 16", 27", and 37" sizes
- Constructed of aluminum with an acrylic diffuser
- Designed for wall or ceiling installation, and can be mounted horizontally or vertically



	Model	Max Lumens	Wattage	Color Temp	CRI	Finish
--	-------	------------	---------	------------	-----	--------

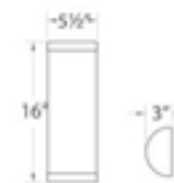

WS-180216	1025	16W	30	3000K	90	BN	Brushed Nickel
-----------	------	-----	----	-------	----	----	----------------



WS-180227	1450	20W	30	3000K	90	BN	Brushed Nickel
-----------	------	-----	----	-------	----	----	----------------



WS-180237	2025	28W	30	3000K	90	BN	Brushed Nickel
-----------	------	-----	----	-------	----	----	----------------

Example: WS-180216-30-BN

STUDIO

THREE-IN-ONE LED CCT SELECTABLE



Input: 120V
Dimming: 100%-10% ELV, 100%-5% TRIAC
Rated Life: 50,000 hours

ALL-IN-ONE CCT SELECTABLE



- Available in a 26" size
- Constructed of aluminum with an acrylic diffuser
- Can be mounted vertically or horizontally for flexible installation



Model	Max Lumens	Wattage	Color Temp	CRI	Finish
-------	------------	---------	------------	-----	--------

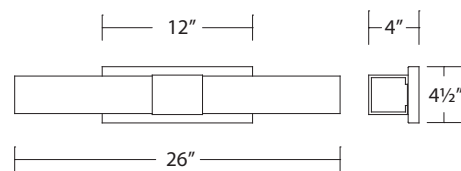

WS-240926	1950	31W	CS 2700K 3000K 3500K	90	BN BK Brushed Nickel Black
-----------	------	-----	-------------------------------	----	-------------------------------------

Example: WS-240926-CS-BK

SLIM

LED VANITY LIGHT OR WALL SCONCE



Input: 120V
Dimming: 100%-10% ELV, 100%-5% TRIAC
Rated Life: 50,000 hours

ALL-IN-ONE CCT SELECTABLE



- Available in 18", 24", 36" sizes
- Constructed of aluminum with an acrylic diffuser
- Can be mounted vertically or horizontally for flexible installation



Model	Max Lumens	Wattage	Color Temp	CRI	Finish
-------	------------	---------	------------	-----	--------

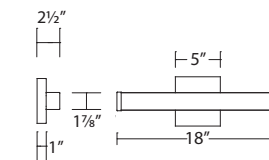

WS-240818	1300	20W	CS 2700K 3000K 3500K 4000K 5000K	90	BN BK Brushed Nickel Black
-----------	------	-----	---	----	-------------------------------------

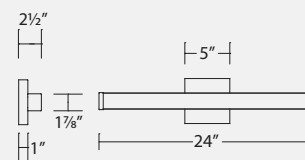

WS-240824	1700	24W	CS 2700K 3000K 3500K 4000K 5000K	90	BN BK Brushed Nickel Black
-----------	------	-----	---	----	-------------------------------------

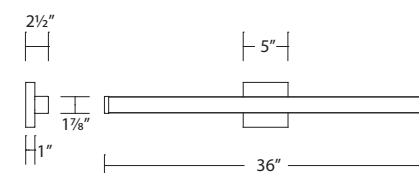

WS-240836	2200	30W	CS 2700K 3000K 3500K 4000K 5000K	90	BN BK Brushed Nickel Black
-----------	------	-----	---	----	-------------------------------------

Example: WS-240824-CS-BK

TURBO

SOFT, DIFFUSED ILLUMINATION



Input: 120-277V
Dimming: 100%-10% ELV, 100%-5% TRIAC
Rated Life: 50,000 hours

- Available in 14" and 24" sizes
- Constructed of aluminum with a dual layer acrylic diffuser

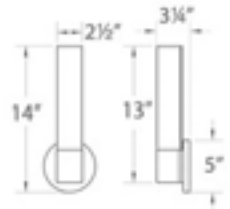
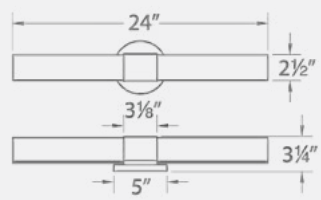

Model	Max Lumens	Wattage	Color Temp	CRI	Finish
 WS-180414	1000	12W	30 3000K	90	BN Brushed Nickel
			35 3500K		CH Chrome
 WS-180424	1570	18W	30 3000K	90	BN Brushed Nickel
			35 3500K		CH Chrome

Example: WS-180414-35-BN



OUTDOOR

Built to perform in demanding environments, outdoor lighting from WAC enhances architecture, landscapes, and pathways with reliable, controlled illumination. Designed to support safety, wayfinding, and visual impact, these fixtures deliver consistent performance across a wide range of exterior applications.

With durable construction and thoughtful optical control, WAC outdoor lighting balances visibility, comfort, and longevity. The result is dependable illumination that extends architectural intent beyond the building and into the surrounding environment.



X-10 OUTDOOR TRACK HEAD

LED ADJUSTABLE BEAM

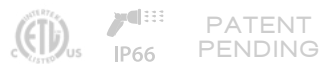

Power: 12W / 12VA
Input: 12V
Dimming: 100%-5%, MLV
Rated Life: 50,000 hours
Construction: Die-cast Aluminum
Standards: ETL & cETL Wet Location Listed

- Continuously adjustable beam angles from 20° - 70° with indexed adjustment markings
- Built-in voltage drop compensation provides consistent output
- Fixtures are polarity agnostic and may be installed to track in either orientation
- High power factor (PF) electronics for optimized VA rating
- Accommodates one lens accessory and one glare control accessory

Model	Color Temp	CRI	Beam	Max Lumens	Max CBCP	Finish
-------	------------	-----	------	------------	----------	--------

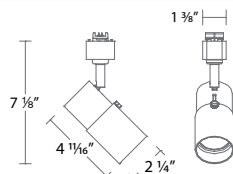

X-10	27	2700K	90	20° - 70°	630	2230	BK	Black
	30	3000K					WT	White

Example: X-10-30BK

ACCESSORY HOLDER

LENS-X10-HLD-BK Required for use with lens and glare control accessory



GLARE CONTROL ACCESSORIES

LENS-16-HCL Honeycomb Louver

LENS ACCESSORIES

- LENS-16-AMB** Amber
- LENS-16-BLU** Blue
- LENS-16-GRN** Green
- LENS-16-RED** Red
- LENS-16-FR** Frosted
- LENS-16-SPR** Spread Lens
- LENS-16-BEL** Beam Elongating

OUTDOOR TRACK COMPONENTS

Track	Model	Finish	Dimensions	Description	
	XT4 XT8	BK Black WT White	48" x 1 3/8" x 1/16" 96" x 1 3/8" x 1/16"	Outdoor Track Constructed from powder-coated aluminum for durability. Requires 10-gauge landscape lighting cable for installation. Supplied with mounting hardware, one pair of joiners, and one end cap. Pre-drilled mounting holes with 8" spacing.	
	Example: XT4-BK				
Transformers & Wires	Model	Finish	Dimensions	Max Power	Description
	9075-TRN 9150-TRN 9300-TRN 9600-TRN	SS Stainless Steel	14" x 5 3/8" x 5 5/8" 18 7/8" x 6 3/4" x 6 1/4" 18 7/8" x 6 3/4" x 6 1/4" 14 1/2" x 10 1/8" x 6"	75W 150W 300W 600W (2x300W outputs)	Outdoor-Rated Stainless Steel Transformer with 12-15V terminals, knockout for power and photo sensor connections, and a 3-prong timer outlet.
	9100-10G 9250-10G	BK Black	100 ft x 7/16" x 3/16" 250 ft x 7/16" x 3/16"		12V Landscape Lighting 10-Gauge Cable Available in 100 ft and 250 ft lengths. Required for each track installation. Determine the distance from the transformer to the end of the track run to select the appropriate cable length.
	Example: 9300-TRN-SS				
Connectors & Hardware	Model	Finish	Dimensions	Description	
	X-FE	BK Black WT White	4" x 1 3/8" x 1/16"	Feed End Used to side or top feed direct wiring to track sections. A canopy plate is required when using with a standard junction box.	
	X-L	BK Black WT White	4" x 4" x 1/16"	L Connector Joins 2 track sections 90°. May be top fed for direct wiring to track sections.	
	X-FLX	BK Black WT White	12 5/8" x 1 3/8" x 1/16"	Flexible Connector Joins 2 track sections at variable angles. Use as a transition from wall-to-wall, wall-to-ceiling, and ceiling-to-ceiling.	
	X-EC	BK Black WT White	2" x 1 3/8" x 1/16"	End Cap Additional end cap. Use at end of track run or open patterns to complete the installation.	
	X-JOIN	BK Black WT White	1 1/16" x 3/16" x 9/16"	I Joiner Additional joiner. Joins two track sections.	
	X-CP	BK Black WT White	5" x 5" x 3/16"	Canopy Plate Covers a junction box. Use with Feed End or L Connector.	
	Example: X-L-BK				
Track Cover	Model	Finish	Dimensions	Description	
	X-COV	BK Black WT White	48" x 1 3/8" x 3/16"	Track Cover Optional field cuttable UV-resistant polycarbonate cover designed to fit channels for a finished look. Two 48" sections included.	
	Example: X-COV-BK				

STEP LIGHTS



Input: 120V, 277V
Brightness: Up to 4 lm
Dimming: 100%-10% ELV (120V only)
Rated Life: 50,000 hours

- Features a fluid, decorative profile with full cut-off illumination
- Constructed of die-cast aluminum with an abrasion-resistant powder-coated finish or a plated brushed nickel finish
- Title 24 compliant (120V only)



WL-LED110-C-WT



WL-LED210-C-BK

Model	Voltage	Wattage	Color Temp	CRI	Finish
WL-LED110-C WL-LED110-AM	120V	3.5W	3000K Amber	90	BK Black on AL BN* Brushed Nickel
WL-LED110F-C WL-LED110F-AM	277V	3W			BZ Bronze on AL WT White on AL

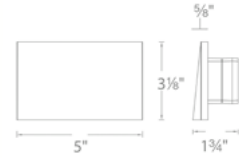

Example: WL-LED110-C-WT

Model	Voltage	Wattage	Color Temp	CRI	Finish
WL-LED210-C WL-LED210-AM	120V	3.5W	3000K Amber	90	BK Black on AL BN* Brushed Nickel
WL-LED210F-C WL-LED210F-AM	277V	3W			BZ Bronze on AL WT White on AL

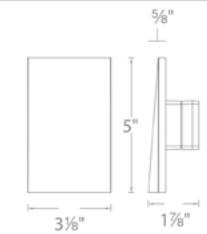

Example: WL-LED210-C-BK

**BN finish is damp location listed and is not warranted for contact with harsh chemicals or exterior installations.*

Input: 120V, 277V
Brightness: Up to 36 lm
Dimming: 100%-10% ELV (120V only)
Rated Life: 50,000 hours

- The louvered design shields the light source to reduce glare and enhance visual comfort.
- Constructed of die-cast aluminum with an abrasion-resistant powder-coated finish.



WL-LED120-C-BK



WL-LED220-C-BZ

Model	Voltage	Wattage	Color Temp	CRI	Finish
WL-LED120-C WL-LED120-AM	120V	3.5W	3000K Amber	90	BK Black on AL BZ Bronze on AL
WL-LED120F-C WL-LED120F-AM	277V	3W			WT White on AL

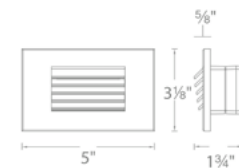

Example: WL-LED120-C-BK

Model	Voltage	Wattage	Color Temp	CRI	Finish
WL-LED220-C WL-LED220-AM	120V	3.5W	3000K Amber	90	BK Black on AL BZ Bronze on AL
WL-LED220F-C WL-LED220F-AM	277V	3W			WT White on AL

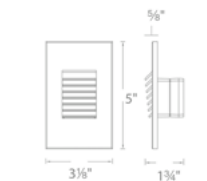

Example: WL-LED220-C-BZ

STEP LIGHTS



Input: 120V, 277V
Brightness: Up to 40 lm
Dimming: 100%-10% ELV (120V only)
Rated Life: 50,000 hours

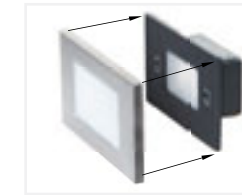

IP66-rated, self-contained fixture offered with multiple faceplate options. It fits into a standard switch box or a 2" x 4" junction box with minimum interior dimensions of 3"L x 2"W x 2.5"D.

- Tempered glass diffuses light for even illumination
- Constructed of die-cast aluminum
- Available with an abrasion-resistant powder-coated finish or a marine-grade stainless steel option
- Title 24 compliant (120V only)
- Mounts vertically or horizontally



Model	Voltage	Wattage	Color Temp	CRI	Finish
WL-LED130-C WL-LED130-AM	120V	3.5W	3000K Amber	90	BK Black on AL BZ Bronze on AL
WL-LED130F-C WL-LED130F-AM	277V	3W			SS Stainless Steel WT White on AL

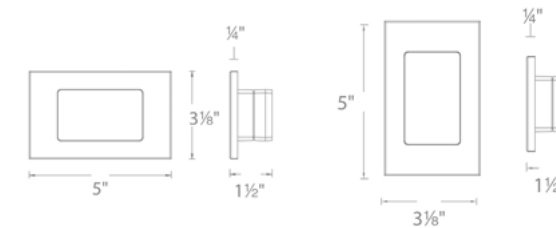

Example: WL-LED130-C-SS

Input: 120V, 277V
Brightness: Up to 3 lm
Dimming: 100%-10% ELV (120V only)
Rated Life: 50,000 hours

- The geometric design provides focused downward illumination
- Constructed of die-cast aluminum with an abrasion-resistant powder-coated finish.
- Title 24 compliant (120V models only).



Model	Voltage	Wattage	Color Temp	CRI	Finish
WL-LED140-C WL-LED140-AM	120V	3.5W	3000K Amber	90	BK Black on AL BZ Bronze on AL
WL-LED140F-C WL-LED140F-AM	277V	3W			WT White on AL

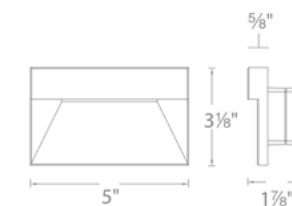

Example: WL-LED140-C-BK

STEP & WALL LIGHTS

BUILT TO ENDURE



Input: 120V, 277V
Rated Life: 54,000 hours

- Options in die-cast brass or 316 marine-grade stainless steel
- Fits into 2"×4" J-Box with minimum inside dimensions of 3"×2"×2"
- IP67, wet location rated for indoor and outdoor installations
- Title 24 JA8 Compliant
- No driver needed
- No heat radiation
- ELV dimming



WL-LED100
Horizontal Scoop



WL-LED200
Vertical Scoop



OUTDOOR

Horizontal Scoop	Model	Input	Color Temp	CRI	Power	Max Lumens	Finish	
	WL-LED100	120V	27	2700K	90	3.5W	65	BBR Bronze on Brass
			30	3000K				
			AM	610nm (Peak) Amber				
	WL-LED100	120V	27	2700K	90	3.5W	65	BK Black on Aluminum
			30	3000K				BN Brush Nickel on Aluminum
			AM	610nm (Peak) Amber				BZ Bronze on Aluminum
			RD	640nm (Peak) Red				GH Graphite on Aluminum
			BL	450nm (Peak) Blue				SS Stainless Steel
	WL-LED201	120V	27	2700K	90	3.5W	65	WT Anti-microbial White
			30	3000K				
			35	3500K				
			AM	610nm (Peak) Amber				

Example: WL-LED100-27-WT

Vertical Scoop	Model	Input	Color Temp	CRI	Power	Max Lumens	Finish	
	WL-LED200	120V	27	2700K	90	3.5W	65	BK Black on Aluminum
			30	3000K				BN Brush Nickel on Aluminum
			AM	610nm (Peak) Amber				BZ Bronze on Aluminum
			RD	640nm (Peak) Red				GH Graphite on Aluminum
			BL	450nm (Peak) Blue				SS Stainless Steel
	WL-LED201	120V	27	2700K	90	3.5W	65	WT Anti-microbial White
			30	3000K				
			35	3500K				
			AM	610nm (Peak) Amber				

Example: WL-LED201-30-WT

Anti-microbial powder coat is proven to restrain a wide range of bacteria, coliform, mold, fungus, algae and yeast.

Use Brass or Stainless Steel Step and Wall Lights for harsh outdoor environments. *BN Finish is not warranted for contact with chemicals or exterior installations.

SPACING RECOMMENDATIONS FOR OPTIMAL LIGHT DISTRIBUTION

Corridors / Hallways

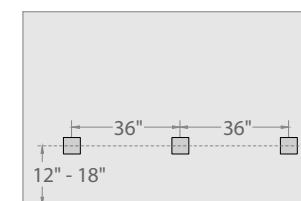

Stairs - Wall Mount

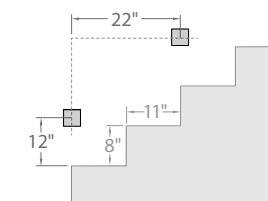

Stairs - Step Mount

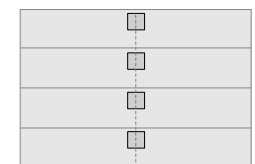

Mount in center of stair as close to the upper tread as possible. For best results use one light per step for steps narrower than 5 feet

ENDURANCE®

LED BRICK LIGHTS



Input: 120V
Dimming: 100% - 10% ELV
Rated Life: 80,000 hours

- Factory-sealed LED light engine
- Die-cast aluminum construction
- 120V direct wire - no driver needed
- Option to easily retrofit incandescent brick lights by others using the existing housings - Consult factory for details



WL-5105
Open Illumination Brick Light



WL-5205
Low Glare Brick Light

	Model	Color Temp	CRI	Power	Max Lumens	Finish
	WL-5105 Opal	30 3000K	90	5.5W	110	aBK Architectural Black aBZ Architectural Bronze aGH Architectural Graphite aWT Architectural White
	WL-5205 Louver	30 3000K	90	5.5W	45	aBK Architectural Black aBZ Architectural Bronze aGH Architectural Graphite aWT Architectural White

Example: WL-5205-30-aBK



OUTDOOR

ENDURANCE®

LED FLOOD LIGHT



Input: 120V
Dimming: 100% - 10% ELV
Rated Life: 54,000 hours



- Breathable waterproof technology and factory-sealed
- LED light engine ensures fixture can maintain stable atmospheric pressure and prevent condensation
- Die-cast aluminum construction
- 120V direct wire—no driver needed
- 2" threaded heavy-duty mounting arm
- Photo or motion sensor sold separately



Ceiling Mounted
 360° Horizontal rotation
 90° Vertical aiming



Shown with Round Canopy Box
 Includes two canopies for use with surface mount or recessed junction boxes

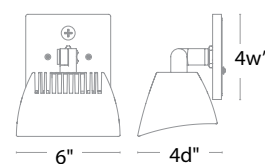

Model	Color Temp	CRI	Power	Comparable	Max Lumens	Finish
WP-LED335 Flood	30	3000K	35.5W	100W HID	2450	aBK Architectural Black aBZ Architectural Bronze aGH Architectural Graphite aWT Architectural White
	50	5000K			2730	
WP-LED354 Flood Pro	35	3500K	53W	150W HID	3445	

Example: WP-LED354-35-aWT

Model	Finish	Description	Features
-------	--------	-------------	----------



MS-120-BK	Black	Motion Sensor (120V)	<ul style="list-style-type: none"> • Detect motion to control on/off. • The double hinge structure allows users to aim the sensor in any position. • Can be mounted on a canopy or on a lighting fixture. • Built-in adjustable timer allows automatic shut off after the sensor coverage area is vacated. • Maximum time delay is 5 minutes, minimum is 5 seconds. • Designed for outdoor (wet location) or indoor application.
MS-120-BZ	Bronze		
MS-120-GY	Gray		
MS-120-WT	White		



PC-120-BK	Black	Photosensor (120V)	<ul style="list-style-type: none"> • Detects the presence of visible light, infrared transmission (IR), and/or ultraviolet (UV) energy in order to control light on/off. • CEC Title 20 Compliant. • Intelligent light control of lighting fixtures based on ambient light. • The mechanical structure allows the user to lock the sensor in any position. • Can be mounted on a canopy or on a lighting fixture.
PC-120-BZ	Bronze		
PC-120-GY	Gray		
PC-120-WT	White		



MP-120-BK	Black	Motion Sensor plus Photocell (120-277V)	<ul style="list-style-type: none"> • Detects motion to control fixtures on/off for adjustable amount of time (10 seconds to 10 minutes) • D2D mode allows sensor to be used as photocell • Motion sensitivity adjustable between 10ft to 50ft (180° cone) • Manual Override the sensor for 5hours by quickly flipping the light switch • Built-In learning function to prevent sensor from being affected by reflected light • Can be mounted on a canopy or on a lighting fixture
MP-120-BZ	Bronze		
MP-120-GY	Gray		
MP-120-WT	White		



OUTDOOR

ENDURANCE®

LED FLOOD LIGHT - SINGLE SPOT



Input: 120V
Dimming: 100% - 10% ELV
Rated Life: 50,000 hours

- Factory-sealed LED light engine
- Die-cast aluminum construction
- 120V direct wire - no driver needed
- Photo/motion sensor sold separately



ENDURANCE®

LED FLOOD LIGHTS - DOUBLE SPOT



Input: 120V
Dimming: 100% - 10% ELV
Rated Life: 50,000 hours

- Factory-sealed LED light engine
- Die-cast aluminum construction
- 120V direct wire - no driver needed
- Photo/motion sensor sold separately



Model	Color Temp	CRI	Power	Comparable	Max Lumens	Finish
WP-LED415	30	3000K	15W	75W Halogen	965	aBK Architectural Black aBZ Architectural Bronze aGH Architectural Graphite aWT Architectural White
	50	5000K			1030	

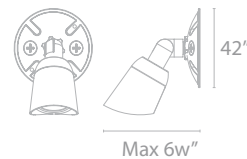





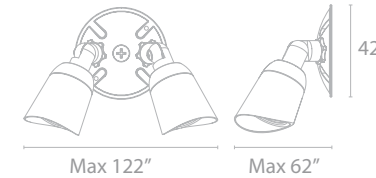

Example: WP-LED415-30-aWT

Model	Color Temp	CRI	Power	Comparable	Max Lumens	Finish
WP-LED430	30	3000K	30W	2 x 75W Halogen	965 x2	aBK Architectural Black aBZ Architectural Bronze aGH Architectural Graphite aWT Architectural White
	50	5000K			1030 x2	



Example: WP-LED430-30-aBZ

Model	Finish	Description	Features
 MS-120-BK MS-120-BZ MS-120-GY MS-120-WT	Black Bronze Gray White	Motion Sensor (120V)	<ul style="list-style-type: none"> • Detect motion to control on/off. • The double hinge structure allows users to aim the sensor in any position. • Can be mounted on a canopy or on a lighting fixture. • Built-in adjustable timer allows automatic shut off after the sensor coverage area is vacated. • Maximum time delay is 5 minutes, minimum is 5 seconds. • Designed for outdoor (wet location) or indoor application.
 PC-120-BK PC-120-BZ PC-120-GY PC-120-WT	Black Bronze Gray White	Photosensor (120V)	<ul style="list-style-type: none"> • Detects the presence of visible light, infrared transmission (IR), and/or ultraviolet (UV) energy in order to control light on/off. • CEC Title 20 Compliant. • Intelligent light control of lighting fixtures based on ambient light. • The mechanical structure allows the user to lock the sensor in any position. • Can be mounted on a canopy or on a lighting fixture.
 MP-120-BK MP-120-BZ MP-120-GY MP-120-WT	Black Bronze Gray White	Motion Sensor plus Photocell (120-277V)	<ul style="list-style-type: none"> • Detects motion to control fixtures on/off for adjustable amount of time (10 seconds to 10 minutes) • D2D mode allows sensor to be used as photocell • Motion sensitivity adjustable between 10ft to 50ft (180° cone) • Manual Override the sensor for 5hours by quickly flipping the light switch • Built-In learning function to prevent sensor from being affected by reflected light • Can be mounted on a canopy or on a lighting fixture

Model	Finish	Description	Features
 MS-120-BK MS-120-BZ MS-120-GY MS-120-WT	Black Bronze Gray White	Motion Sensor (120V)	<ul style="list-style-type: none"> • Detect motion to control on/off. • The double hinge structure allows users to aim the sensor in any position. • Can be mounted on a canopy or on a lighting fixture. • Built-in adjustable timer allows automatic shut off after the sensor coverage area is vacated. • Maximum time delay is 5 minutes, minimum is 5 seconds. • Designed for outdoor (wet location) or indoor application.
 PC-120-BK PC-120-BZ PC-120-GY PC-120-WT	Black Bronze Gray White	Photosensor (120V)	<ul style="list-style-type: none"> • Detects the presence of visible light, infrared transmission (IR), and/or ultraviolet (UV) energy in order to control light on/off. • CEC Title 20 Compliant. • Intelligent light control of lighting fixtures based on ambient light. • The mechanical structure allows the user to lock the sensor in any position. • Can be mounted on a canopy or on a lighting fixture.
 MP-120-BK MP-120-BZ MP-120-GY MP-120-WT	Black Bronze Gray White	Motion Sensor plus Photocell (120-277V)	<ul style="list-style-type: none"> • Detects motion to control fixtures on/off for adjustable amount of time (10 seconds to 10 minutes) • D2D mode allows sensor to be used as photocell • Motion sensitivity adjustable between 10ft to 50ft (180° cone) • Manual Override the sensor for 5hours by quickly flipping the light switch • Built-In learning function to prevent sensor from being affected by reflected light • Can be mounted on a canopy or on a lighting fixture

ENDURANCE® FIN

LED WALL PACKS



Input: 120V-277V
Dimming: 100%-15% ELV
 100%-30% 0-10V
Rated Life: 100,000 hours

- Factory-sealed LED light engine
- Die-cast aluminum construction
- 20° forward throw illumination
- Built-in level for easy adjustment
- Photo/Motion sensor sold separately



Tempered Prismatic Glass
 Reduces glare while optimizing light distribution

ENDURANCE® HAWK

LED WALL PACKS



Input: 120V-277V
Dimming: 100%-15% ELV
 100%-30% 0-10V
Rated Life: 100,000 hours

- Factory-sealed LED light engine
- Die-cast aluminum construction
- 20° forward throw illumination
- Built-in level for easy adjustment
- Photo/Motion sensor sold separately



Mounts in any orientation
 For direct and indirect illumination



Includes box sleeve
 For use with surface mount junction boxes

Model	Color Temp	CRI	Power	Comparable	Max Lumens	Finish
-------	------------	-----	-------	------------	------------	--------

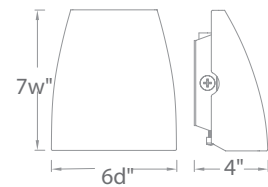

WP-LED119			19W	39W HID	1390	aBZ Architectural Bronze
WP-LED127	30 3000K	85	27W	70W HID	2075	aGH Architectural Graphite
WP-LED135			35W	100W HID	2750	aWT Architectural White

Example: WP-LED119-30-aGH

Model	Color Temp	CRI	Power	Comparable	Max Lumens	Finish
-------	------------	-----	-------	------------	------------	--------

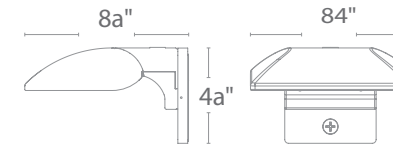

WP-LED219			19W	39W HID	1435	aBZ Architectural Bronze
WP-LED227	30 3000K	85	27W	70W HID	2095	aGH Architectural Graphite
						aWT Architectural White

Example: WP-LED219-30-aBZ

Model	Finish	Description	Features
-------	--------	-------------	----------



MS-120-BK
 MS-120-BZ
 MS-120-GY
 MS-120-WT

Motion Sensor (120V)

- Detect motion to control on/off.
- The double hinge structure allows users to aim the sensor in any position.
- Can be mounted on a canopy or on a lighting fixture.
- Built-in adjustable timer allows automatic shut off after the sensor coverage area is vacated.
- Maximum time delay is 5 minutes, minimum is 5 seconds.
- Designed for outdoor (wet location) or indoor application.



PC-120-BK
 PC-120-BZ
 PC-120-GY
 PC-120-WT

Photosensor (120V)

- Detects the presence of visible light, infrared transmission (IR), and/or ultraviolet (UV) energy in order to control light on/off.
- CEC Title 20 Compliant.
- Intelligent light control of lighting fixtures based on ambient light.
- The mechanical structure allows the user to lock the sensor in any position.
- Can be mounted on a canopy or on a lighting fixture.



MP-120-BK
 MP-120-BZ
 MP-120-GY
 MP-120-WT

Motion Sensor plus Photocell (120-277V)

- Detects motion to control fixtures on/off for adjustable amount of time (10 seconds to 10 minutes)
- D2D mode allows sensor to be used as photocell
- Motion sensitivity adjustable between 10ft to 50ft (180° cone)
- Manual Override the sensor for 5hours by quickly flipping the light switch
- Built-In learning function to prevent sensor from being affected by reflected light
- Can be mounted on a canopy or on a lighting fixture

Model	Finish	Description	Features
-------	--------	-------------	----------



MS-120-BK
 MS-120-BZ
 MS-120-GY
 MS-120-WT

Motion Sensor (120V)

- Detect motion to control on/off.
- The double hinge structure allows users to aim the sensor in any position.
- Can be mounted on a canopy or on a lighting fixture.
- Built-in adjustable timer allows automatic shut off after the sensor coverage area is vacated.
- Maximum time delay is 5 minutes, minimum is 5 seconds.
- Designed for outdoor (wet location) or indoor application.



PC-120-BK
 PC-120-BZ
 PC-120-GY
 PC-120-WT

Photosensor (120V)

- Detects the presence of visible light, infrared transmission (IR), and/or ultraviolet (UV) energy in order to control light on/off.
- CEC Title 20 Compliant.
- Intelligent light control of lighting fixtures based on ambient light.
- The mechanical structure allows the user to lock the sensor in any position.
- Can be mounted on a canopy or on a lighting fixture.



MP-120-BK
 MP-120-BZ
 MP-120-GY
 MP-120-WT

Motion Sensor plus Photocell (120-277V)

- Detects motion to control fixtures on/off for adjustable amount of time (10 seconds to 10 minutes)
- D2D mode allows sensor to be used as photocell
- Motion sensitivity adjustable between 10ft to 50ft (180° cone)
- Manual Override the sensor for 5hours by quickly flipping the light switch
- Built-In learning function to prevent sensor from being affected by reflected light
- Can be mounted on a canopy or on a lighting fixture

ENDURANCE®

ADJUSTABLE WALL-MOUNTED LED SPOTLIGHT



Input: 120V
Dimming: 100% - 10% ELV
Rated Life: 50,000 hours

Designed for sign lighting or wall mounted lighting in any direction

- Factory-sealed LED light engine
- Die-cast aluminum construction
- 120V direct wire - no driver needed

360° Rotation on axis

Rotate to continuously adjust beam angles indexed at 15° to 60°

Safety cable recommended for extensions over 36"

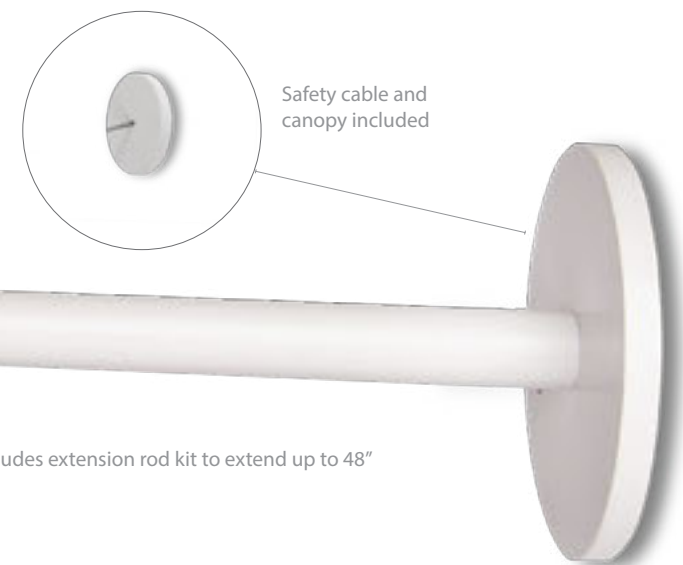

Safety cable and canopy included

Includes extension rod kit to extend up to 48"



WP-LED529
Double

Detachable Shroud

Model	Color Temp	CRI	Power	Comparable	Max Lumens	Finish
WP-LED514 Single	30	3000K	15W	150W PAR 38	1140	aBK Architectural Black
	40	4000K				aBZ Architectural Bronze
						aGH Architectural Graphite
						aWT Architectural White
WP-LED529 Double	30	3000K	30W	150W x2 PAR 38	1140 x2	aBK Architectural Black
	40	4000K				aBZ Architectural Bronze
						aGH Architectural Graphite
						aWT Architectural White

Example: WP-LED529-30-aWT

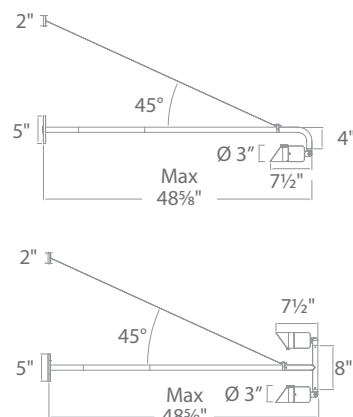

WP-LED514
Single

Rotate 180°



Includes extension rod kit to extend up to 48"

Extendable rod

PHOTOMETRICS

Power - 15W Per Head

Beam Setting	Distance	Foot Candles	Beam Diameter
15°	2'	1036 fc	1/2'
	3'	460 fc	1'
	4'	259 fc	1'
25°	2'	600 fc	1'
	3'	267 fc	1 1/2'
	4'	150 fc	2'
40°	2'	378 fc	1 1/2'
	3'	168 fc	2'
	4'	95 fc	3'
60°	2'	219 fc	2 1/2'
	3'	93 fc	3 1/2'
	4'	54 fc	4 1/2'

RUBIX

LED CEILING MOUNTS



Input: 120-277V
Dimming: 100% - 10% ELV or 0-10V
Rated Life: 70,000 hours

- Ceiling mount
- Die-cast aluminum construction



FM-W2505



FM-W2510

Model	Color Temp	CRI	Power	Beam	Max Lumens	Finish
 FM-W2505	3000K	90	16W	86°	750	AL Brushed Aluminum
						BK Black
						BZ Bronze
						GH Graphite
						WT White
 FM-W2510	3000K	90	30W	95°	1875	AL Brushed Aluminum
						BK Black
						BZ Bronze
						GH Graphite
						WT White

Example: FM-W2505-WT

RUBIX

LED WALL MOUNTS



- Mounts up or down
- Die-cast aluminum construction

Input: 120-277V
Dimming: 100%-10% ELV 100%-5% 0-10V
Rated Life: 70,000 hours



Model	Color Temp	CRI	Power	Beam	Max Lumens	Finish	
 WS-W2509 Single Light	3000K	90	16W	86°	805	AL Brushed Aluminum	
						BK Black	
							BZ Bronze
							GH Graphite
							WT White

Example: WS-W2509-WT



- Mounts up or down
- Die-cast aluminum construction

Input: 120-277V
Dimming: 100%-10% ELV 100%-5% 0-10V
Rated Life: 70,000 hours

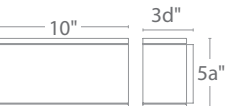

Model	Color Temp	CRI	Power	Beam	Max Lumens	Finish	
 WS-W2510 Up & Down Light	3000K	90	30W	86°	1385	AL Brushed Aluminum	
						BK Black	
							BZ Bronze
							GH Graphite
							WT White

Example: WS-W2510-GH



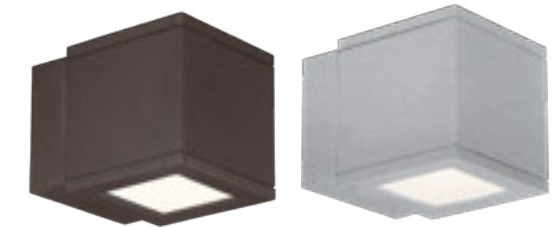

- Mounts up or down
- Die-cast aluminum construction

Input: 120-277V
Dimming: 100%-10% ELV 100%-5% 0-10V
Rated Life: 70,000 hours

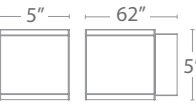

Single Light
WS-W2504
(Dark Sky)

Double Light
WS-W2505

Model	Color Temp	CRI	Power	Beam	Max Lumens	Finish	
 WS-W2504 Single Light	3000K	90	16W	86°	750	AL Brushed Aluminum	
						BK Black	
							BZ Bronze
							GH Graphite
							WT White
 WS-W2505 Up & Down Light	3000K	90	30W	86°	1400	AL Brushed Aluminum	
						BK Black	
							BZ Bronze
							GH Graphite
							WT White

Example: WS-W2504-BZ

TUBE

LED PENDANT



Input: 120-277V
Dimming: 100%-10% ELV 100%-5% 0-10V
Rated Life: 70,000 hours

- Die-cast aluminum construction
- Hang straight swivel
- Three 12" and one 6" down rods included



PD-W2605

Model	Color Temp	CRI	Power	Beam	Max Lumens	Finish
PD-W2605	3000K	90	16W	33°	800	AL Brushed Aluminum BK Black BZ Bronze GH Graphite WT White

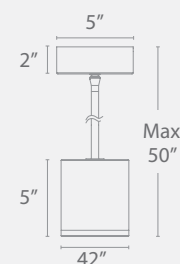

Example: PD-W2605-BK

TUBE

LED WALL MOUNTS



Input: 120-277V
Dimming: 100%-10% ELV 100%-5% 0-10V
Rated Life: 70,000 hours

- Die-cast aluminum construction
- Single light mounts up or down



WS-W2605
(Dark Sky)



WS-W2604

Model	Color Temp	CRI	Power	Beam	Max Lumens	Finish
WS-W2605 Single Light	3000K	90	16W	33°	800	AL Brushed Aluminum BK Black BZ Bronze GH Graphite WT White
WS-W2604 Up & Down Light	3000K	90	30W	33°	1750	AL Brushed Aluminum BK Black BZ Bronze GH Graphite WT White

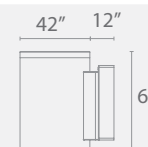
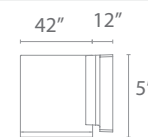

Example: WS-W2605-AL

TUBE

LED CEILING MOUNTS



Input: 120-277V
Dimming: 100%-10% ELV 100%-5% 0-10V
Rated Life: 70,000 hours

- Ceiling mount
- Die-cast aluminum construction



FM-W2605



FM-W2612

Model	Color Temp	CRI	Power	Beam	Max Lumens	Finish
FM-W2605	3000K	90	16W	35°	800	AL Brushed Aluminum BK Black BZ Bronze GH Graphite WT White
FM-W2612	3000K	90	30W	91°	1740	AL Brushed Aluminum BK Black BZ Bronze GH Graphite WT White

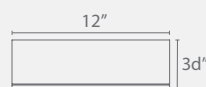
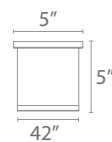

Example: FM-W2605-WT

TUBE

LED WALL MOUNTS



Input: 120-277V
Dimming: 100%-10% ELV 100%-5% 0-10V
Rated Life: 70,000 hours

- Die-cast aluminum construction
- Single light mounts up or down



WS-W2609
(Dark Sky)



WS-W2610

Model	Color Temp	CRI	Power	Beam	Max Lumens	Finish
WS-W2609 Single Light	3000K	90	16W	70°	825	AL Brushed Aluminum BK Black BZ Bronze GH Graphite WT White
WS-W2610 Up & Down Light	3000K	90	30W	70°	1525	AL Brushed Aluminum BK Black BZ Bronze GH Graphite WT White

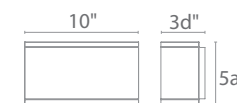

Example: WS-W2609-BK



CUBIX & CYLINDER

ENTRANCE & WALKWAY ILLUMINATING



Input: 120V
 Dimming: 100%-10% ELV
 Rated Life: 50,000 hours

ALL-IN-ONE CCT SELECTABLE



- Available in 7½" single-light and 9½" double-light models
- Constructed from die-cast aluminum for durability and refined detail
- Finished with a powder-coated aluminum surface for lasting performance



WS-W220208-CS-BZ



WS-W220212-CS-BK



WS-W190208-CS-WT



WS-W190212-CS-BZ

	Model	Wattage	Max Lumens	Color Temp	CRI	Finish
	WS-W220208 Cubix Single Light	10W	780	CS 2700K 3000K 3500K 4000K 5000K	80	BK Black BZ Bronze WT White
	WS-W220212 Cubix Double Light	20W	1520	CS 2700K 3000K 3500K 4000K 5000K	80	BK Black BZ Bronze WT White
	WS-W190208 Cylinder Single Light	10W	745	CS 2700K 3000K 3500K 4000K 5000K	80	BK Black BZ Bronze WT White
	WS-W190212 Cylinder Double Light	20W	1585	CS 2700K 3000K 3500K 4000K 5000K	80	BK Black BZ Bronze WT White

Example: WS-W220208-CS-BK

CYLINDER

LED INDOOR/OUTDOOR SCENCE



Input: 120V
Dimming: 100%-10% ELV
Rated Life: 50,000 hours

- Constructed of aluminum and engineered with a TIR lens for optimal optical performance.
- Finished in durable, powder-coated aluminum.

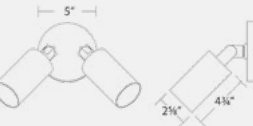

Model	Max Lumens	Wattage	Color Temp	CRI	Finish
 WS-W230301	1375	17W	30 3000K	90	BK Black BZ Bronze WT White
 WS-W230302	1375 x 2	33W	30 3000K	90	BK Black BZ Bronze WT White

Example: WS-W230301-30-BK

LANTERN

ILLUMINATE OUTDOOR SPACES



Input: 120V
Dimming: 100%-10% ELV, 100%-5% TRIAC
Rated Life: 50,000 hours

ALL-IN-ONE CCT SELECTABLE



- Features a built-in photosensor that automatically controls on/off operation.
- Constructed of aluminum with a dual-layer acrylic diffuser lens.
- Finished in durable, powder-coated aluminum.

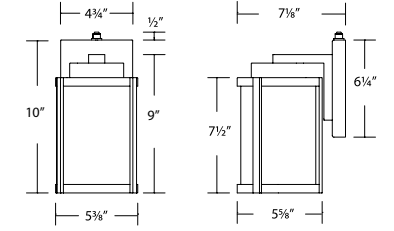
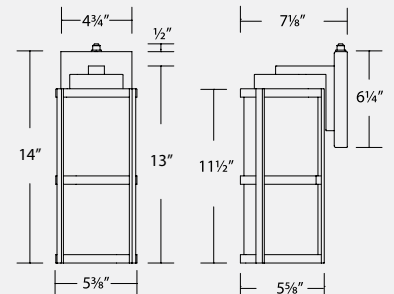

Model	Wattage	Max Lumens	Color Temp	CRI	Finish
 WS-W250110	11W	470	CS 2700K 3000K 3500K 4000K 5000K	90	BK Black BZ Bronze WT White
 WS-W250114	15W	660	CS 2700K 3000K 3500K 4000K 5000K	90	BK Black BZ Bronze WT White

Example: WS-W250110-CS-BK

CAP

INDOOR/OUTDOOR SCONCE



Input: 120V
Dimming: 100%-10% ELV, 100%-5% TRIAC
Rated Life: 50,000 hours

- Constructed of aluminum with a glass diffuser
- Finished in durable, powder-coated aluminum



TABLET

UPWARD AND DOWNWARD ILLUMINATION



Input: 120V
Dimming: 100%-10% ELV, 100%-5% TRIAC
Rated Life: 50,000 hours

- Constructed of aluminum with a glass diffuser
- Finished in durable, powder-coated aluminum

ALL-IN-ONE CCT SELECTABLE

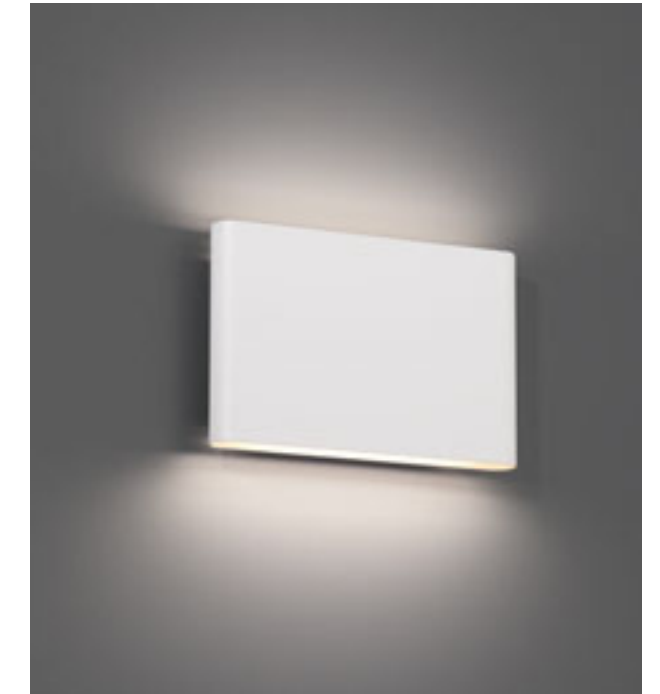

Cap	Model	Wattage	Max Lumens	Color Temp	CRI	Finish
-----	-------	---------	------------	------------	-----	--------

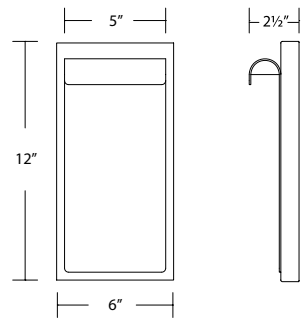

WS-W250212	13W	215	CS	2700K	90	BK Black	
				3000K			
				3500K			GHBK Graphite on Black
				4000K			WTBK White on Black
				5000K			WT White

Example: WS-W250212-CS-BK

Tablet	Model	Wattage	Max Lumens	Color Temp	CRI	Finish
--------	-------	---------	------------	------------	-----	--------

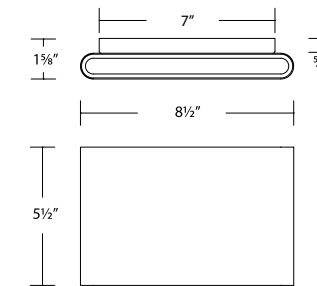

WS-W250305	17W	790	CS	2700K	90	BK Black	
				3000K			
				3500K			BZ Bronze
				4000K			WT White
				5000K			

Example: WS-W250305-CS-BK

MIDTOWN



Input: 120V
 Dimming: 100%-10% ELV
 Rated Life: 50,000 hours

ALL-IN-ONE CCT SELECTABLE

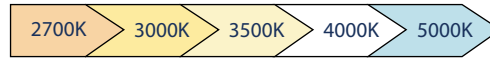

- Available in 10" and 15" sizes
- Constructed from aluminum with an acrylic diffuser for even illumination
- Finished with a powder-coated aluminum surface for long-lasting durability



	Model	Max Lumens	Wattage	Color Temp	CRI	Finish
	WS-W241310	375	12W	CS 2700K 3000K 3500K 4000K 5000K	90	BK Black
	WS-W241315	625	15W	CS 2700K 3000K 3500K 4000K 5000K	90	BK Black

Example: WS-W241310-CS-BK

VEGA



Input: 120V
 Dimming: 100%-10% ELV
 Rated Life: 50,000 hours

ALL-IN-ONE CCT SELECTABLE



- Available in 9" and 14" sizes
- Constructed from die-cast aluminum with an acrylic diffuser for even illumination
- Finished with a powder-coated aluminum surface for long-lasting durability



	Model	Max Lumens	Wattage	Color Temp	CRI	Finish
	WS-W190109	665	13W	CS 2700K 3000K 3500K 4000K 5000K	90	BK Black
	WS-W190114	1375	26W	CS 2700K 3000K 3500K 4000K 5000K	90	BK Black

Example: WS-W190114-CS-BK

INDOOR/OUTDOOR TABLE LAMPS

Our indoor/outdoor table lamps bring cohesive style and elevated ambiance to residential and hospitality settings. Rechargeable and cordless, they offer effortless placement and illumination wherever light is needed.

Available in four refined silhouettes, each lamp features a streamlined profile suited to patios, dining tables, and outdoor entertaining.

Thoughtfully crafted for atmospheric lighting, these portables enhance any environment with effortless style and inviting warmth both indoors and out.

Input: USB-C
 Dimming: Onboard
 CRI: 85+

- Tap to switch between color temperatures on 3CCT models, or hold to dim
- Suitable for indoor or outdoor use
- Power supply and USB-C cable included



PLEAT









DARLA

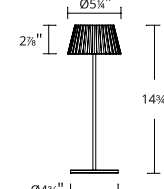

CHANNING

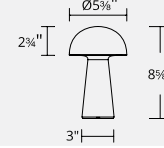

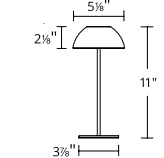
CRYSTAL

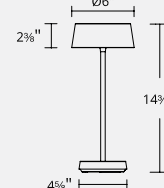
Table Lamps	Model	Wattage	Max Lumens	Color Temp	Battery Life	Finish
 	TL-W251115	2W	200	CS 2200K 2700K 3000K	10+ hours	BK Black BZ Bronze GR Green WT White
 	TL-W251209	2W	160	CS 2200K 2700K 3000K	8+ hours	BK Black GR Green WT White
 	TL-W251511	2W	200	CS 2200K 2700K 3000K	10+ hours	BK Black GR Green WT White
 	TL-W251315	2W	220	27 2700K	7+ hours	BK Black WT White

Example: TL-W251511-CS-GR *Model TL-W251315 (Crystal) does not change CCT.

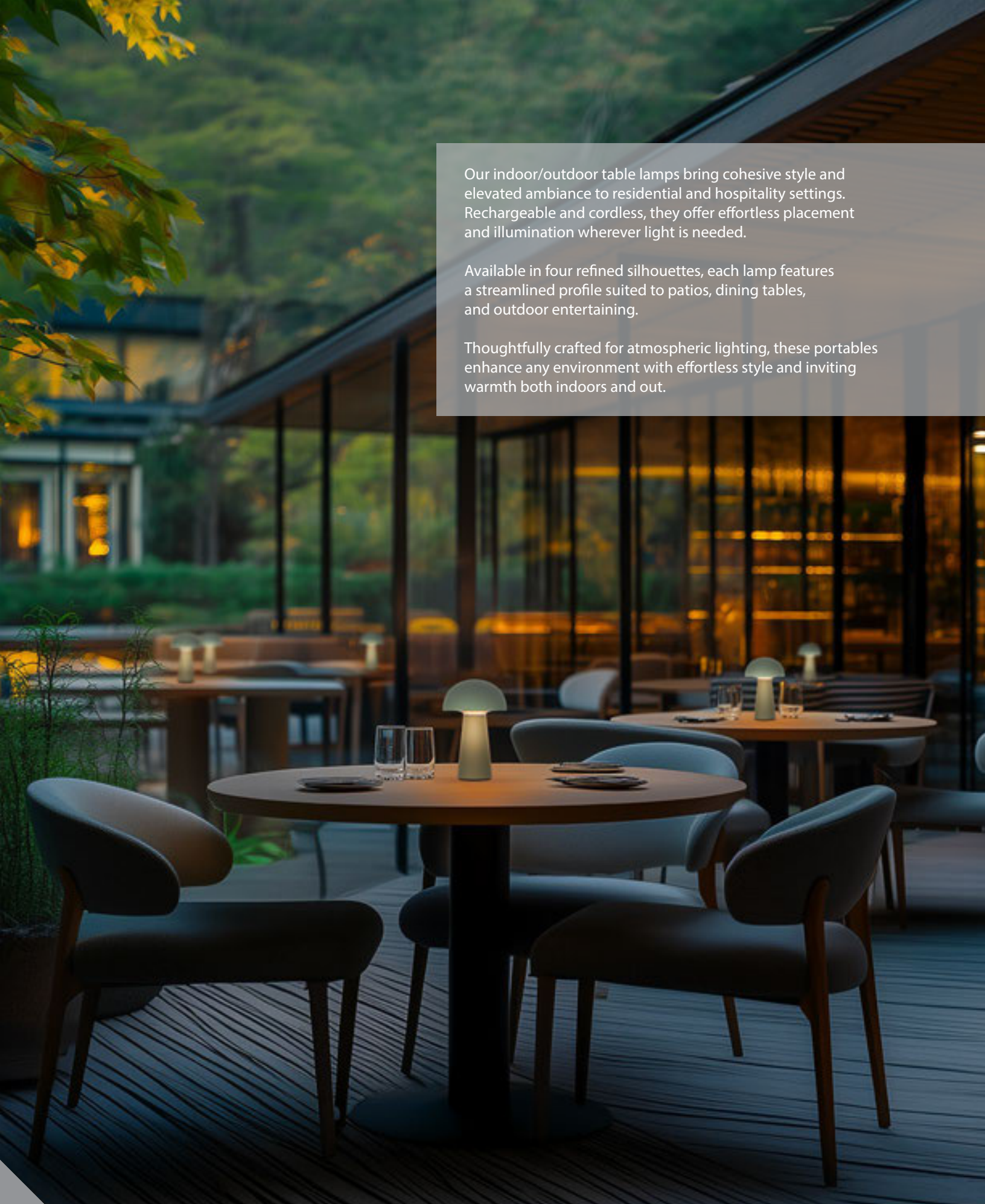



ALL-IN-ONE CCT SELECTABLE

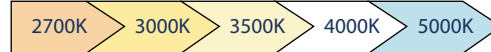

OUTDOOR

SPOTT

Input: 9-15VAC
 Rated Life: 50,000 hours

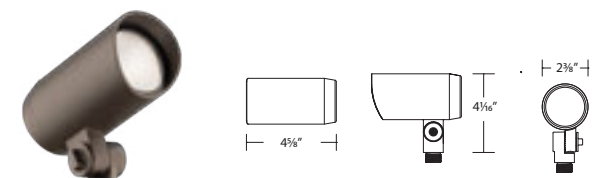

- The mounting stake includes a foot push bar for easy installation
- It is designed with a shroud to help reduce glare
- A 5CCT switch is hidden under the back cap for a clean aesthetic
- A side-mounted knob allows for tool-less tilt adjustment
- Constructed of aluminum with a glass lens

Model	Beam	Max Lumens	Wattage	Color Temp	Finish
LC-253205	F 35°	560	7W	2700K	BZ Bronze
		3000K			
	W 60°	535		3500K	
		4000K			
	5000K				

Example: LC-253205-FCS-BZ

LANTERN, STAFF, CONE

Input: 9-15VAC
 Rated Life: 50,000 hours



- The mounting stake includes a foot push bar for easy installation
- Comes with two separate 10" rods to allow for height adjustment
- A 5CCT switch is hidden for a clean aesthetic
- Constructed of aluminum with a polycarbonate lens

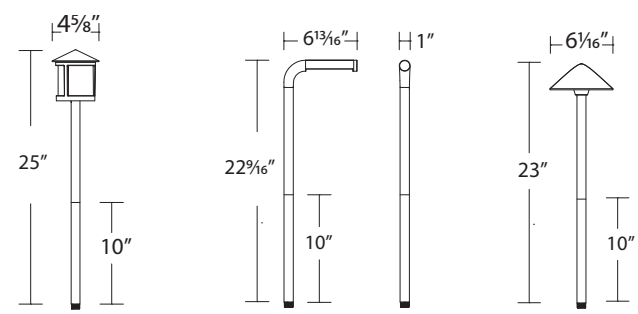

Model	Max Lumens	Wattage	Color Temp	Finish
LC-253305	155	3W	2700K	BZ Bronze
LC-253401	225	4W	3000K	
LC-253507	150	4W	3500K	
			4000K	
			5000K	

Example: LC-253305-CS-BZ

12V MAGNETIC TRANSFORMER

Input: 120V
 Output: 12VAC
 Rated Life: 50,000 hours

- Features a built-in on/off photocell with a timer that adjusts to sunset and sunrise
- Two channels support separate lighting runs
- Includes a 6-foot cord and plug for power
- Constructed of stainless steel



Magnetic Transformer	Model	Wattage	Finish
----------------------	-------	---------	--------

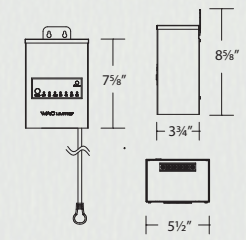

LC-2531100	100W	SS	Stainless Steel
LC-2531200	200W		

Example: LC-2531100-SS

CIRKEL & PLAYNE

Input: 9-15VAC
 Rated Life: 50,000 hours



- The clip-in mounting system features an integrated wire slot for streamlined installation
- A 5CCT switch is hidden on the back for a clean aesthetic
- Constructed of aluminum with an acrylic lens

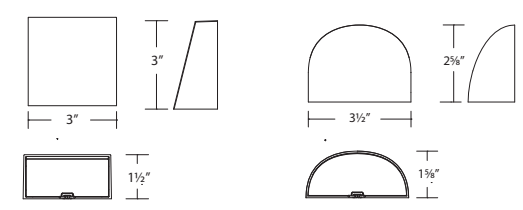

Model	Max Lumens	Wattage	Color Temp	Finish
LC-253603	140	3W	2700K	BZ Bronze
LC-253703	115		3000K	
			3500K	
			4000K	
			5000K	

Example: LC-253603-CS-BZ



FANS

Designed to support comfort and efficiency, fans from WAC Lighting provide reliable air movement for both indoor and outdoor spaces. Thoughtful engineering and balanced performance help improve circulation while complementing a wide range of architectural and interior styles.

With quiet operation and durable construction, our fans offer dependable performance across residential and light commercial environments. Integrated controls and adaptable configurations make them an easy fit for projects where comfort, efficiency, and long term reliability matter.



DISC II



Blade:	12° pitch, 52" sweep, plywood
Downrod:	¾" W x 4½" H included
Mounting Slope:	Up to 30° standard, 45° with optional Slope Ceiling Kit
Lead Wire:	80"
Hanging Weight:	18 lbs
Lumens/Delivered Lumens:	2520-2620/1692-1746
Total Power:	52W
LED Power:	26W
CRI:	90
Color Temperature:	2700K, 3000K, 4000K, 5000K
LED Rated Life:	50,000 hrs
LED Dimming:	100%-10% ELV/ TRIAC (Refer to online product page for dimming compatibility)

- Equipped with a 3-speed 120 × 15 DC motor designed for quiet yet powerful performance
- Features precision-balanced blades to ensure smooth, wobble-free operation
- Pull-chain control with reversible functionality directly from the housing
- Energy Star® certified for exceptional energy efficiency and performance
- Includes a memory module that automatically recalls the last speed setting when power is restored



ENERGY GUIDE

Standard	High Speed	Weighted Average
Electricity	25W	17W
Airflow	5,032 CFM	3,964 CFM
Energy Costs*	-	\$5/yr
Efficiency	237 CFM/W	237 CFM/W

Estimated annual energy cost based on \$0.12 per kWh and 6.4 hours use per day

Disc II	Model	Housing	Blade
---------	-------	---------	-------

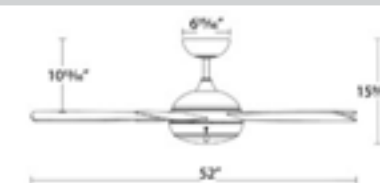

F-033L	BN	Brushed Nickel	Brushed Nickel Matte Black Matte White
	MB	Matte Black	
	MW	Matte White	

Example: F-033L-Bn

ACCESSORIES (Sold Separately)

DC Coupler	BN	Brushed Nickel	12"	DR Downrods	BN	Brushed Nickel
	MB	Matte Black	18"		MB	Matte Black
	MW	Matte White	24"		MW	Matte White
SC Slope Ceiling Kit	BN	Brushed Nickel	36"			
	MB	Matte Black	48"			
			60"			
			72"			

ATLANTIS



Blade: 13° pitch, 52" sweep, plywood
Downrod: ¾" W x 6" H included
Mounting Slope: Up to 30° standard, 45° with optional Slope Ceiling Kit
Lead Wire: 80"
Hanging Weight: 18 lbs
Lumens/Delivered Lumens: 1991-2159 (Based on CCT)/850
Total Power: 85W
LED Power: 21W
CRI: 90
Color Temperature: 3000K
LED Rated Life: 50,000 hrs
LED Dimming: 100%-10% ELV/TRIAC (Refer to online product page for dimming compatibility)



- Offers three fan speeds to customize comfort for any space
- Powered by a silent 153 x 16 AC motor for reliable, whisper-quiet performance
- Features pull-chain operation for convenient manual control
- Reversible directly from the housing for year-round use and optimal airflow direction

ENERGY GUIDE

Standard	High Speed	Weighted Average
Electricity	63W	40W
Airflow	5,001 CFM	3,717 CFM
Energy Costs*	-	\$11/yr
Efficiency	92 CFM/W	92 CFM/W

Estimated annual energy cost based on \$0.12 per kWh and 6.4 hours use per day

Atlantis	Model	Housing	Blade
----------	-------	---------	-------

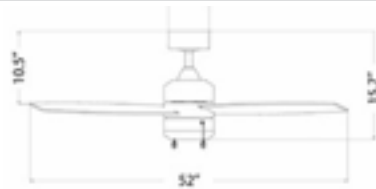

F-072L

MB Matte Black
MW Matte White

Matte Black
Matte White

Example: F-072L-MB

ACCESSORIES (Sold Separately)

DC Coupler	BN	Brushed Nickel
	MB	Matte Black
	MW	Matte White
SC Slope Ceiling Kit	BN	Brushed Nickel
	MB	Matte Black
	MW	Matte White

DR Downrods

12"
18"
24"
36"
48"
60"
72"

BN Brushed Nickel
MB Matte Black
MW Matte White

ACCESSORIES (Order Separately)



WC26-WT

Compatible with AC-motor fan models (Atlantis, Hug, and Quade), this fan speed and TRIAC control is rated 120V AC, 60Hz. Its slim form factor and pre-attached lead wires deliver a clean, integrated multi-gang installation.

ATLANTIS FLUSH



Blade: 13° pitch, 52" sweep, plywood
Lead Wire: 8"
Hanging Weight: 18 lbs
Lumens/Delivered Lumens: 1991-2159 (Based on CCT)/850
Total Power: 85W
LED Power: 21W
CRI: 90
Color Temperature: 3000K
LED Rated Life: 50,000 hrs
LED Dimming: 100%-10% ELV/TRIAC (Refer to online product page for dimming compatibility)



- Offers three fan speeds to customize comfort for any space.
- Powered by a silent 153 x 16 AC motor for reliable, whisper-quiet performance
- Features pull-chain operation for convenient manual control
- Reversible directly from the housing for year-round use and optimal airflow direction

ENERGY GUIDE

Standard	High Speed	Weighted Average
Electricity	63W	40W
Airflow	4,116 CFM	3,046 CFM
Energy Costs*	-	\$11/yr
Efficiency	75 CFM/W	75 CFM/W

Estimated annual energy cost based on \$0.12 per kWh and 6.4 hours use per day

Atlantis Flush	Model	Housing	Blade
----------------	-------	---------	-------

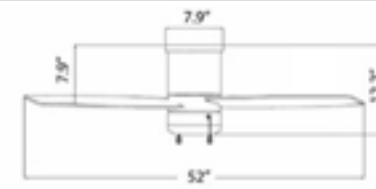

F-073L

MB Matte Black
MW Matte White

Matte Black
Matte White

Example: F-073L-MB

ACCESSORIES (Sold Separately)

DC Coupler	BN	Brushed Nickel
	MB	Matte Black
	MW	Matte White
SC Slope Ceiling Kit	BN	Brushed Nickel
	MB	Matte Black
	MW	Matte White

DR Downrods

12"
18"
24"
36"
48"
60"
72"

BN Brushed Nickel
MB Matte Black
MW Matte White

ACCESSORIES (Order Separately)



WC26-WT

Compatible with AC-motor fan models (Atlantis, Hug, and Quade), this fan speed and TRIAC control is rated 120V AC, 60Hz. Its slim form factor and pre-attached lead wires deliver a clean, integrated multi-gang installation.



QUADE



Blade:	13 degrees 52"
Downrod:	0.75 ID x 6"H
Mounting Slope:	Up to 30
Lead Wire:	80"
Hanging Weight:	15 lbs
Lumens/Delivered Lumens:	1991 - 2159 (Based on CCT) / 980
Total Power:	64W
LED Power:	21W
CRI:	90
Color Temperature:	2700K, 3000K, 4000K, 5000K (selectable)
LED Rated Life:	50,000 hrs
LED Dimming:	100%-10% ELV/TRIAC (Refer to online product page for dimming compatibility)

- Offers three fan speeds to customize comfort for any space.
- Powered by a silent 153 x 20 AC motor for reliable, whisper-quiet performance
- Features pull-chain operation for convenient manual control
- Reversible directly from the housing for year-round use and optimal airflow direction

ENERGY GUIDE

Standard	High Speed	Weighted Average
Electricity	43W	29W
Airflow	4,533 CFM	3,504 CFM
Energy Costs*	-	\$8/yr
Efficiency	124 CFM/W	124 CFM/W

Estimated annual energy cost based on \$0.12 per kWh and 6.4 hours use per day



Quade	Model	Housing	Blade
-------	-------	---------	-------

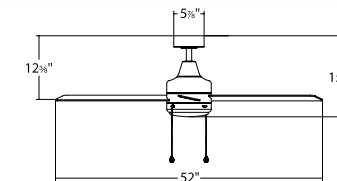

F-106L	BN Brushed Nickel	Brushed Nickel
	MB Matte Black	Matte Black
	MW Matte White	Matte White

Example: F-106L-MB

ACCESSORIES (Sold Separately)

DC Coupler	BN Brushed Nickel	12"
	MB Matte Black	18"
	MW Matte White	24"
SC Slope Ceiling Kit	BN Brushed Nickel	36"
	MB Matte Black	48"
	MW Matte White	60"

DR Downrods

12"	BN Brushed Nickel
18"	MB Matte Black
24"	MW Matte White
36"	
48"	
60"	
72"	

ACCESSORIES (Order Separately)



WC26-WT

Compatible with AC-motor fan models (Atlantis, Hug, and Quade), this fan speed and TRIAC control is rated 120V AC, 60Hz. Its slim form factor and pre-attached lead wires deliver a clean, integrated multi-gang installation.

HUG PULL CHAIN 44



Blade:	16 degrees 44"
Lead Wire	8"
Hanging Weight:	15.1lbs
Lumens/Delivered Lumens:	1991 - 2159 (Based on CCT) / 999
Total Power:	71W
LED Power:	21W
CRI:	90
Color Temperature:	2700K, 3000K, 4000K, 5000K (selectable)
LED Rated Life:	50,000 hrs
LED Dimming:	100%-10% ELV/ TRIAC (Refer to online product page for dimming compatibility)

- Offers three fan speeds to customize comfort for any space
- Powered by a silent 153 x 18 AC motor for reliable, whisper-quiet performance
- Features pull-chain operation for convenient manual control
- Reversible directly from the housing for year-round use and optimal airflow direction



ENERGY GUIDE

Standard	High Speed	Weighted Average
Electricity	50W	31W
Airflow	4218 CFM	3020 CFM
Energy Costs*	-	\$9/yr
Efficiency	96 CFM/W	96 CFM/W

Estimated annual energy cost based on \$0.12 per kWh and 6.4 hours use per day

ACCESSORIES (Order Separately)



WC26-WT

Compatible with AC-motor fan models (Atlantis, Hug, and Quade), this fan speed and TRIAC control is rated 120V AC, 60Hz. Its slim form factor and pre-attached lead wires deliver a clean, integrated multi-gang installation.

Hug Pull Chain 44	Model	Housing	Blade
-------------------	-------	---------	-------

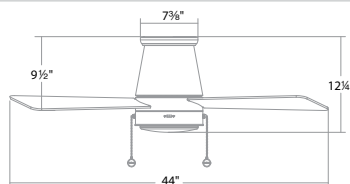

F-107L

BN	Brushed Nickel
MB	Matte Black
MW	Matte White

Brushed Nickel
Matte Black
Matte White

Example: F-107L-MB

HUG PULL CHAIN 52



Blade:	16 degrees 52"
Lead Wire	8"
Hanging Weight:	15.7lbs
Lumens/Delivered Lumens:	1991 - 2159 (Based on CCT) / 999
Total Power:	71W
LED Power:	21W
CRI:	90
Color Temperature:	2700K, 3000K, 4000K, 5000K (selectable)
LED Rated Life:	50,000 hrs
LED Dimming:	100%-10% ELV/ TRIAC (Refer to online product page for dimming compatibility)

- Offers three fan speeds to customize comfort for any space
- Powered by a silent 153 x 18 AC motor for reliable, whisper-quiet performance
- Features pull-chain operation for convenient manual control
- Reversible directly from the housing for year-round use and optimal airflow direction

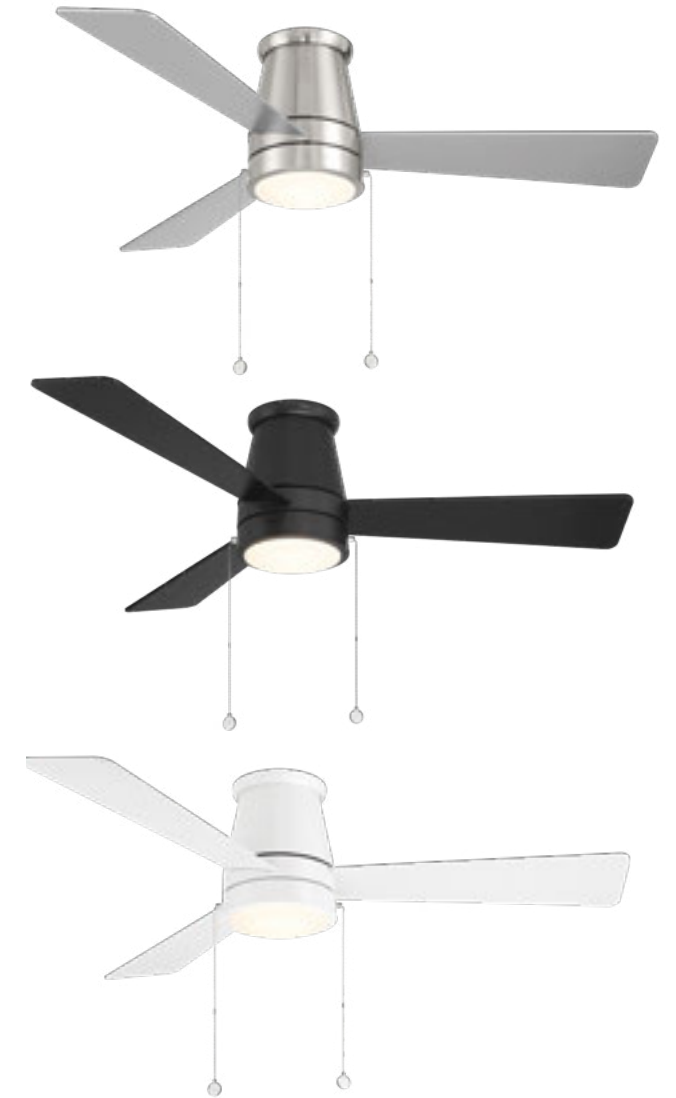

ENERGY GUIDE

Standard	High Speed	Weighted Average
Electricity	50W	31W
Airflow	4323 CFM	3113 CFM
Energy Costs*	-	\$9/yr
Efficiency	99 CFM/W	99 CFM/W

Estimated annual energy cost based on \$0.12 per kWh and 6.4 hours use per day

ACCESSORIES (Order Separately)



WC26-WT

Compatible with AC-motor fan models (Atlantis, Hug, and Quade), this fan speed and TRIAC control is rated 120V AC, 60Hz. Its slim form factor and pre-attached lead wires deliver a clean, integrated multi-gang installation.

Hug Pull Chain 52	Model	Housing	Blade
-------------------	-------	---------	-------

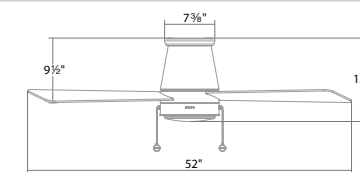

F-108L

BN	Brushed Nickel
MB	Matte Black
MW	Matte White

Brushed Nickel
Matte Black
Matte White

Example: F-108L-MB

INDEX

#

2.5" LOW VOLTAGE RECESSED	74
4" LOW VOLTAGE RECESSED	75
12V MAGNETIC TRANSFORMER	128

A

ALUMINUM CHANNELS	16
ATLANTIS	138
ATLANTIS FLUSH	139

B

BARLIGHT	19
BLO	87
BULLET	41
BUTTON LIGHTS	26

C

CAP	126
CHARGE	40
CIRKEL	133
CONE	133
CUBIX	122
CYLINDER	123, 124
CYN	41

D

DEW	93
DISC	85
DISC II	136
DUET BUTTON LIGHTS	24

E

EDGELESS	82
ENDURANCE® ADJUSTABLE SPOTLIGHT	116
ENDURANCE® DOUBLE SPOT	113
ENDURANCE® FIN	114
ENDURANCE® FLOOD	110
ENDURANCE® HAWK	115
ENDURANCE® BRICK LIGHTS	108
ENDURANCE® SINGLE SPOT	112
ENDURANCE® STEP LIGHT	106

F

FLO	87
FQ BASIC 2"	54
FUSE	95

G

GEMINI	14
GLO	87

H

H TRACK	40-46
H TRACK CURRENT LIMITER	45
HUG PULL CHAIN 44	142
HUG PULL CHAIN 52	143

I

I CAN'T BELIEVE IT'S NOT RECESSED	84
INDOOR/OUTDOOR LAMPS	130
INVISILED DUET	6
INVISILED LITE+	8
INVISILED PRO+	9
INVISILED PRO 2+	10
INVISILED PRO 3	11
ION	70

J

J TRACK	42-48
J2 TRACK	43

K

KENRIC	68
--------	----

L

LANTERN	125, 133
L TRACK	42-48
LED90	18
LEDME DUO	18
LITHIUM	88
LOTOS	60-67
LOW VOLTAGE MONOPOINT	50

M

METRO	94
MIDTOWN	128
MINI PUCK LIGHT	28
MR16 TRACK LUMINAIRE	51

O

OCULARC 1.0	56
OCULARC 2.0	57
OCULARC 3.0	58
OCULARC 7011	32
OCULARC DIM-TO-WARM 7011	33
OCULARC 7012	34
OCULARC 7013	35
OCULARC 7030	36
OCULARC 3020W	37

P

PAR & BR TRACK	50
PATRIOT	71
PIPE	39
PLAYNE	133
POP-IN	72
PUCK LIGHT	29

Q

QUADE	140
-------	-----

R

ROUND	90-92
RUBIX	118

S

SLIM	97
SOLO	38
SOLO 5010	41
STEP LIGHTS (ENDURANCE®)	106
STEP LIGHTS (LIMITED)	104
STUDIO	96
SPOTT	133
STAFF	133

T

TABLET	127
TUBE	120
TURBO	98
TWIST-N-LITE	78

U

UNDER CABINET STRIP PLUG & PLAY	20
---------------------------------	----

V

VEGA	129
------	-----

X

X-10 OUTDOOR TRACK	102
--------------------	-----

Headquarters

Tel: 800.526.2588
Fax: 800.526.2585

44 Harbor Park Dr
Port Washington, NY 11050

South East

1600 Distribution Ct
Lithia Springs, GA 30122

Central

1700 South J Elmer Freeway
Suite 100
Cedar Hill, TX 75104

West

1750 S Archibald Ave
Ontario, CA 91761

Consult our manufacturing facility to take advantage of our custom capabilities for large quantities. For up-to-date product specifications and assistance please visit wacighting.com or call **1-800-526-2588**

This catalog includes patented and patent-pending products or features. We will not hesitate to enforce our intellectual property rights through injunctive relief and seek further relief through damages if we have reason to believe the patents are being infringed.

© 2026 WAC Group

All rights reserved. This catalog is copyrighted and WAC Group reserves the right to use any and all measures available to it under the law against anyone who copies or derives from its copyrighted work.

WAC GROUP
TECHNOLOGY ILLUMINATED

© 2026 WAC GROUP