



WAC LIGHTING®

LANDSCAPE SOLUTIONS 2026



ABOUT LANDSCAPE LIGHTING

WAC Lighting redefines what outdoor illumination can achieve, blending advanced engineering with purposeful design to shape landscapes after dark. From subtle accents that reveal texture and form to bold gestures that anchor pathways, water features, and architectural moments, every element in the collection is crafted to elevate the beauty, safety, and usability of exterior spaces while maintaining a clean, stylish presence during daylight hours.

Rooted in innovation and built for real-world performance, these luminaires offer precise optical control, selectable color temperatures, rugged construction, and seamless integration with the WAC Colorscaping ecosystem. Whether enhancing a private residence, a hospitality environment, or expansive public grounds, WAC Lighting delivers landscape lighting solutions that inspire design, simplify installation, and endure the elements with confidence.

Our Patents Solve Everyday Landscape Challenges

Thoughtful landscapes demand lighting that adapts as designs evolve. Our patented technologies give designers precise control in the field, so light performs exactly as intended long after installation.

Shape Light With Precision

Patented adjustable optics allow beam spreads to be refined on site, shifting from narrow to wide distributions to suit architecture, walls, and textures without changing fixtures.



Direct Light With Intent

Indexed aiming systems make it easy to orient illumination horizontally or vertically, ensuring wall washes and accents align cleanly with the space they define.

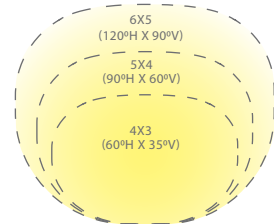
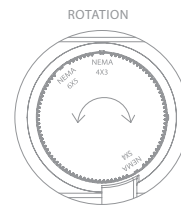

Control Without Complexity

Integrated internal output adjustment lets light levels be fine tuned at the fixture, delivering consistent results across varying conditions and distances.

Built to Evolve

Quick release connections simplify service and updates, while digital two wire control enables dynamic color and effects, ensuring long term flexibility as landscapes change.



Color, Without the Complexity

Fun without the fuss. Traditional two wire installation paired with our patented Colorscaping technology brings landscape lighting to life with ease. Unlock millions of colors, tunable white, and crisp white light, all controlled digitally without added infrastructure or complicated commissioning. Dynamic when you want it, refined when you do not, Colorscaping delivers expressive lighting that remains practical, reliable, and built for real world landscapes.



Table of Contents

PRODUCTS WITH COLORSCAPING TECHNOLOGY

Accent	6 - 11	2" Indicator Lights	30 - 31
Wall Wash	12 - 13	Underwater Spot	32 - 35
In-Ground	14 - 15	Deck & Patio	36 - 37
Path	16 - 23	Tape Light	38 - 39
Cylinder Wall Mount	24 - 25	Accessories	40 - 41
Hardscape.....	26 - 27		
Step Light	28 - 29		

12V LED LANDSCAPE LIGHTING

Accent	44 - 53	Path	74 - 95
Wall Wash	54 - 57	Bollard	96 - 119
In-Ground + Indicator	58 - 63	Deck & Patio	120 - 121
Submersible	64 - 67	Step Lights	122 - 129
Tree Lights	68 - 69	Landscape Tape Lighting	130 - 137
Cylinder Wall Mount	70 - 71	Outdoor Track	138 - 139
Hardscape	72 - 73		

120V & 277V EXTERIOR LED LIGHTING

Line Voltage Landscape	140 - 141
Wall Mount	142 - 145
Decorative	146 - 149
Limited	150 - 151

ACCESSORIES & PHOTOMETRICS

Transformers/Accessories	152 - 154
Photometrics.....	155 - 167
Index	168





LANDSCAPE SOLUTIONS WITH COLORSCAPING TECHNOLOGY

Colorscaping is a dynamic landscape lighting system that brings precision, flexibility, and expressive control outdoors. From warm whites to rich color and tunable light, it allows designers to shape atmosphere, highlight form, and adapt environments with ease, all on a simple, two-wire platform.



ARTFUL ILLUMINATION FOR THE OUTDOORS

Colorscaping, WAC Group's advanced outdoor lighting technology, transforms your landscape into a dynamic, expressive environment with tunable white and full-spectrum color. From subtle moods to bold visual statements, you can shape every tree, wall, path, and outdoor room to match the moment. Warm tones invite relaxation and dining, cooler whites improve nighttime clarity, and rich colors highlight plant life or architectural features.



TECHNIQUES TO ILLUMINATE YOUR LANDSCAPE WITH COLORSCAPING

- Tune white light to make evergreen trees greener and Japanese maples redder
- Position luminaires in tall trees to cast a moonlighting effect on the ground and watch shadows change with the wind
- For outdoor entertaining and nighttime activities, use warm white light to deliver an inviting vibe and relaxing atmosphere
- For safety, security, or simply a stunning look, use cooler color temperatures to increase the visibility of your outdoor space
- Create five or more different scenes in one evening, especially during the holiday seasons
- Spotlight distinctive vegetation in unique colors to complement foliage changes
- Make a white house "whiter" by lighting it to stand out against other homes
- Schedule beautiful sunrise and sunset scenes to enhance the warmth and beauty of your home



INNOVATIVE TRANSFORMER CONTROL PANEL



Onboard Control Panel

Control Colorscaping products using standard 2-conductor landscape wiring

Control legacy / white light products on the same transformer with On/Off and dimming control

Smart Magnetic Transformer - PATENTED

Stainless Steel, 15VAC output, IP65 rated, UL 1838 listed
See transformer spec sheet for details and its accessories

Ordering Chart

150W Max	300W Max
8150CS-TRN-SS	8300CS-TRN-SS

SMART SIMPLICITY, POWERFUL CONTROL

The MyWAC app puts complete lighting control at your fingertips. Easily create scenes, set schedules, and fine tune brightness and color across individual fixtures or entire zones. For quick access, the Wi-Fi Wall Station provides instant scene selection at the touch of a button. Together, they deliver intuitive, responsive control that lets you shape the mood of your outdoor environment instantly, from subtle highlights to fully coordinated lighting moments.

QUICK FIXTURE DISCOVERY

Automatically identifies each luminaire so fixtures can be added, changed, or paired with the correct transformer at the push of a button.

FAST SETUP & TESTING

Onboard controls let you cycle through tunable white presets and primary colors for instant verification in the field.

SMART, ROBUST DESIGN

Available in 150W and 300W models with robust wiring support and built-in surge protection.

FLEXIBLE CONTROL OPTIONS

Operate via Wi-Fi, wired Ethernet, or DMX. Control fixtures independently, in groups, or as part of a scene.

INDIVIDUAL FIXTURE CONTROL

Using standard two-conductor landscape wiring, each luminaire can be adjusted for brightness and color.

LEGACY-COMPATIBLE

Connect existing landscape fixtures to bring them into the Colorscaping system for unified scheduling and dimming through the MyWAC app.



ACCENT



PATENTED

Precision-engineered with an adjustable 20°–60° beam, this accent fixture delivers focused illumination with exceptional control. Designed for landscape and architectural applications, it offers tunable white and full color output, individual fixture addressing, and seamless integration into scenes, schedules and automations.

- Adjustable beam angle from 20° - 60°
- Fixtures can be individually controlled in addition to grouping, scheduling and automations
- Full white light tunability from 2700K to 6500K
- Fixtures can generate millions of colors



Input	Power	Brightness	Beam Angle	CRI	Rated Life	
15VAC	15W / 16VA	White	570lm	20° - 60°	85	50,000 hours
		Red	185lm			
		Green	385lm			
		Blue	90lm			

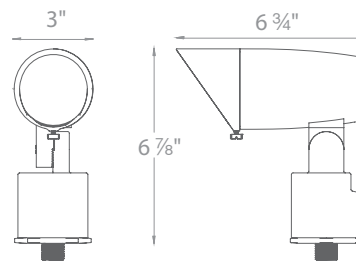
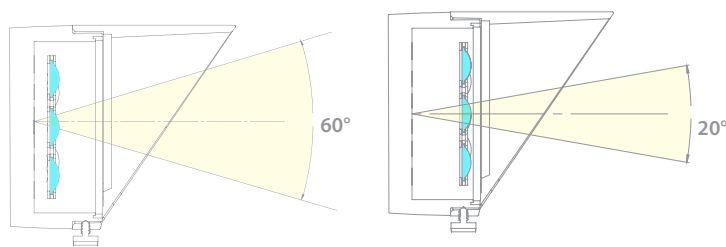

Ordering Chart

15V	Fixture Finish Options:	Accessories
5811-CS	BK Black on Aluminum	Extension Rods
	BZ Bronze on Aluminum	Rod L-Coupler
	BBR Bronze on Brass	Accent Long Shroud
	Example: 5811-CSBZ	Accent Snoot
	Colorscape Smart Transformer is required	5000-X04-BZ,BK,BBR 5000-LCO-BK 5010-LSHR-BK 5010-SNOOT-BK
	See Accessories page for more detail	5000-X08-BZ,BK,BBR 5000-LCO-BZ 5010-LSHR-BZ 5010-SNOOT-BZ
	9" Mounting stake, detachable shroud,	5000-X12-BZ,BK,BBR 5010-LSHR-BBR 5010-SNOOT-BBR
	6' lead wire and direct-burial gel-filled wire nuts included	5000-X18-BZ,BK,BBR
		5000-X24-BZ,BK,BBR

Mounting Stake	Surface Mount Flange/Stake	Guardian Mount	Gutter Mount Bracket	Honeycomb Louver
9000-ST9-BZ	5000-SCP-BK 5000-SCP-BZ 5000-SCP-BBR	9000-SP9-BZ	5000-GM-BK 5000-GM-BZ	5011-HCL







PATENTED

GRAND ACCENT



Engineered for powerful performance, this adjustable accent fixture delivers precise illumination with a 20°–70° beam range. Designed for demanding landscape and architectural applications, it offers tunable white and full color output, individual fixture control, and seamless integration into scenes, schedules, and automations.

- Adjustable beam angle from 20° - 70°
- Fixtures can be individually controlled in addition to grouping, scheduling and automations
- Full white light tunability from 2700K to 6500K
- Fixtures can generate millions of colors

Input	Power	Brightness	Beam Angle	CRI	Rated Life
15VAC	24W / 25VA	White Red Green Blue	1120lm 375lm 735lm 170lm	20° - 70°	85 50,000 hours

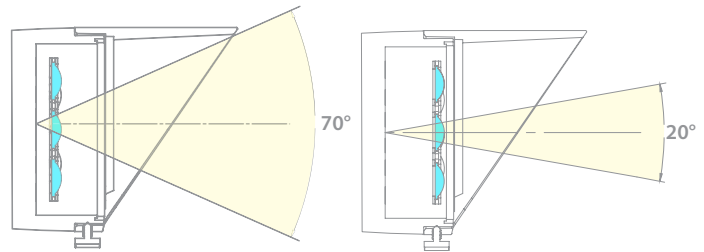
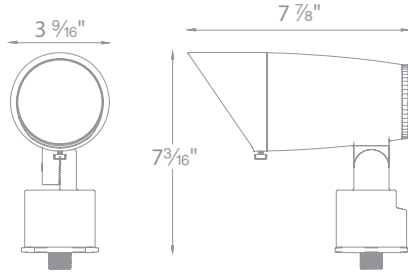

Accessories

Tree Mount Junction Box	Extension Rods	Rod L-Coupler	5" Long Shroud
5000-TCP-BK 5000-TCP-BZ	5000-X04-BZ,BK,BBR 5000-X08-BZ,BK,BBR 5000-X12-BZ,BK,BBR 5000-X18-BZ,BK,BBR 5000-X24-BZ,BK,BBR	5000-LCO-BK 5000-LCO-BZ	5211-LSHR-BK 5211-LSHR-BZ 5211-LSHR-BBR

Ordering Chart

15V	Fixture Finish Options:
5812-CS	BK Black on Aluminum BZ Bronze on Aluminum BBR Bronze on Brass

Example: **5812-CSBZ**
 Colorscaping Smart Transformer is required
 See Accessories page for more detail
 9" Mounting stake, detachable shroud,
 6' lead wire and direct-burial gel-filled wire nuts included

Grand Accent Long Shroud	Grand Accent Snoot	Mounting Stake	Surface Mount Flange/Stake	Guardian Mount	Gutter Mount Bracket	Honeycomb Louver
5211-LSHR-BK 5211-LSHR-BZ 5211-LSHR-BBR	5211-SNOOT-BK 5211-SNOOT-BZ 5211-SNOOT-BBR	9000-ST9-BZ	5000-SCP-BK 5000-SCP-BZ 5000-SCP-BBR	9000-SP9-BZ	5000-GM-BK 5000-GM-BZ	5011-HCL

POWER ACCENT



PATENTED



Designed for high-output applications, this accent fixture delivers powerful illumination via fixed-beam optics for precise control. Available in multiple lens angles, it offers tunable white and full color output, individual fixture control, and seamless integration into scenes, schedules, and automations.

- Fixed lens beam angles for more power
- Lens angle options: 15°, 25°, 45° and 60° included
- Fixtures can be individually controlled in addition to grouping, scheduling and automations
- Full white light tunability from 2700K to 6500K
- Fixtures can generate millions of colors



Input	Power	Brightness	Beam Angle	CRI	Rated Life	
15VAC	14W / 15VA	White	1125lm	15°, 25°, 45°, 60°	85	50,000 hours
		Red	700lm			
		Green	1160lm			
		Blue	170lm			

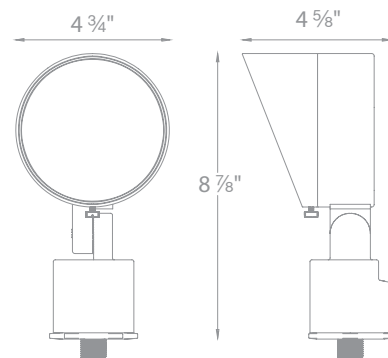

Ordering Chart

15V

Fixture Finish Options:

5813-CS

- BK** Black on Aluminum
- BZ** Bronze on Aluminum
- BBR** Bronze on Brass

Example: **5813-CSBZ**

Colorscaping Smart Transformer is required
See Accessories page for more detail
9" Mounting stake, detachable shroud,
6' lead wire and direct-burial gel-filled wire nuts included

Accessories

Mounting Stake	Surface Mount Flange/Stake	Guardian Mount	Gutter Mount Bracket	Tree Mount Junction Box	Extension Rods	Rod L-Coupler
9000-ST9-BZ	5000-SCP-BK 5000-SCP-BZ 5000-SCP-BBR	9000-SP9-BZ	5000-GM-BK 5000-GM-BZ	5000-TCP-BK 5000-TCP-BZ	5000-X04-BZ,BK,BBR 5000-X08-BZ,BK,BBR 5000-X12-BZ,BK,BBR 5000-X18-BZ,BK,BBR 5000-X24-BZ,BK,BBR	5000-LCO-BK 5000-LCO-BZ







PATENTED

WALL WASH



Designed to deliver a smooth, uniform wash from a compact form factor, this wall wash fixture provides consistent illumination across vertical surfaces. With tunable white and full color output, individual fixture control, and seamless scene integration, it enables refined architectural lighting with precise control.

- A uniform wide distribution wall wash from a small form factor
- Fixtures can be individually controlled in addition to grouping, scheduling and automations
- Full white light tunability from 2700K to 6500K
- Fixtures can generate millions of colors

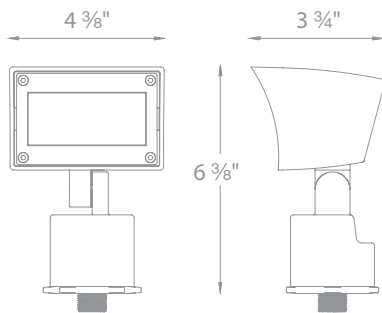

Input	Power	Brightness	Beam Angle	CRI	Rated Life
15VAC	16W / 24.5VA	White Red Green Blue	1015lm 360lm 680lm 140lm	50° x 80°	85 50,000 hours

Ordering Chart

15V

Fixture Finish Options:

5821-CS

- BK** Black on Aluminum
- BZ** Bronze on Aluminum
- BBR** Bronze on Brass

Example: **5821-CSBZ**

Colorscaping Smart Transformer is required

See Accessories page for more detail

9" Mounting stake, detachable shroud,

6' lead wire and direct-burial gel-filled wire nuts included

Accessories

Mounting Stake	Surface Mount Flange/Stake	Guardian Mount	Gutter Mount Bracket	Tree Mount Junction Box	Extension Rods	Rod L-Coupler
9000-ST9-BZ	5000-SCP-BK 5000-SCP-BZ 5000-SCP-BBR	9000-SP9-BZ	5000-GM-BK 5000-GM-BZ	5000-TCP-BK 5000-TCP-BZ	5000-X04-BZ,BK,BBR 5000-X08-BZ,BK,BBR 5000-X12-BZ,BK,BBR 5000-X18-BZ,BK,BBR 5000-X24-BZ,BK,BBR	5000-LCO-BK 5000-LCO-BZ

IN-GROUND



PATENTED



Designed for flush mounting, this in-ground fixture delivers focused illumination with adjustable beam angles for precise control. Ideal for landscape and architectural applications, it offers tunable white and full color output, individual fixture addressing, and seamless integration into scenes, schedules, and automations.



- Adjustable beam angle from 20° - 70°
- Directional aim with +/- 20° Tilt
- Fixtures can be individually controlled in addition to grouping, scheduling and automations
- Full white light tunability from 2700K to 6500K
- Fixtures can generate millions of colors

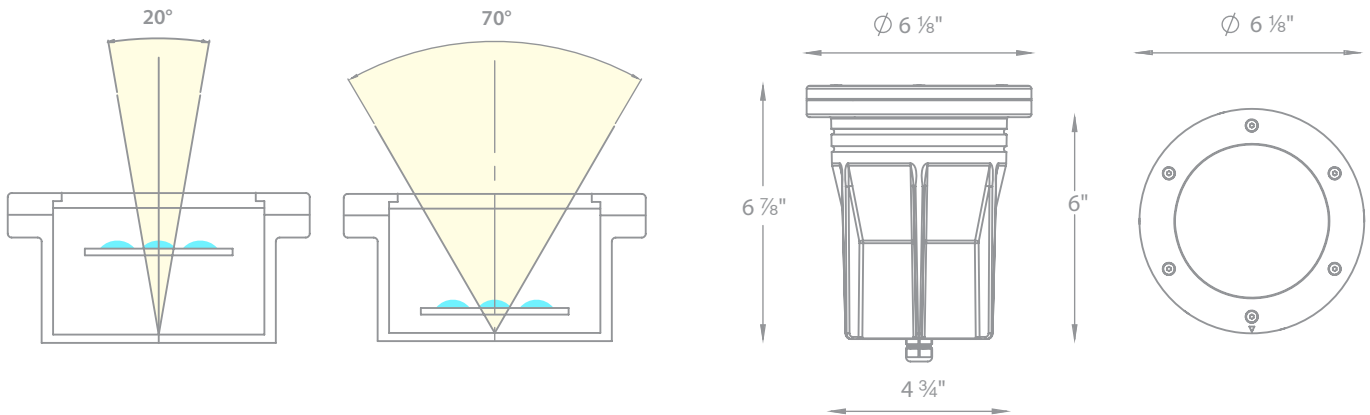

Input	Power	Brightness	Beam Angle	CRI	Rated Life	
15VAC	23W / 24VA	White	1020lm	20° - 70°	85	50,000 hours
		Red	330lm			
		Green	720lm			
		Blue	175lm			

Ordering Chart

15V	Fixture Finish Options:
5831-CS	BZ Bronze on Aluminum
	BBR Bronze on Brass

Accessories

Anti-Glare Shroud	Rock Guard	Concrete Pour Kit
5033-SHR-BZ	5830-GRD-BZ	5830-PIP-PVC
5033-SHR-BBR	5830-GRD-BBR	

Example: **5831-CSBZ**

Colorscaping Smart Transformer is required
See Accessories page for more detail







PATENTED

LINEAR PATH LIGHT



A low-profile, linear form delivers even, glare-controlled illumination for pathways and accent applications. Fully rotatable and lockable for precise aiming, this fixture offers tunable white and full color output, individual control, and seamless integration into scenes, schedules and automations.

- Low profile and discreet
- 80° fully rotatable fixture aiming
- Lock desired position in place after adjustment
- Wide Flood Beam 120° x 90°
- Adjustable anti-glare shroud
- Designed for soft ground, wood floor and concrete
- Base mount, riser mount & extension mount
- Path & Accent applications

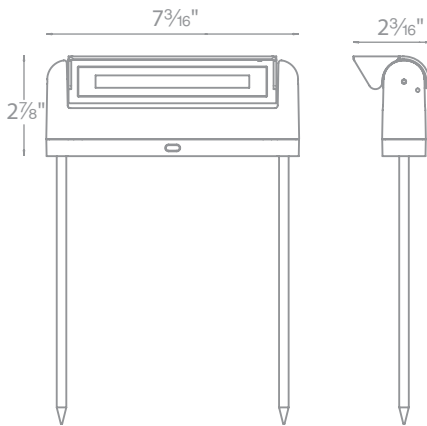

Input	Power	Brightness	Beam Angle	CRI	Rated Life
15VAC	5W / 8VA	White Red Green Blue	275lm 65lm 190lm 40lm	120° x 90°	85 50,000 hours

Ordering Chart

15V	Fixture Finish Options:
6401-CS	BK Black on Aluminum BZ Bronze on Aluminum

Example: **6401-CSBK**

Colorscape Smart Transformer is required
See Accessories page for more detail
Detachable shroud, 10' lead wire and direct-burial gel-filled wire nuts included



Extension mount connector included
(Order extension rods separately)



Optional riser attachment included

Accessories

9" Mounting Stake	Extension Rods
9000-ST9-BZ	5000-X04-BZ,BK 5000-X08-BZ,BK 5000-X12-BZ,BK 5000-X18-BZ,BK 5000-X24-BZ,BK

BALANCE



A sleek, linear form blends seamlessly into pathways while delivering soft, even illumination. Designed for visual comfort and control, this fixture offers tunable white and full-color output, individual fixture addressing, and responsive control for coordinated scenes and time-based lighting.

- Sleek linear design blends seamlessly into pathways while providing soft, even illumination
- Fixtures can be individually controlled in addition to grouping, scheduling and automations
- Full white light tunability from 2700K to 6500K
- Fixtures can generate millions of colors

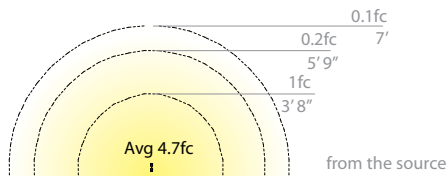
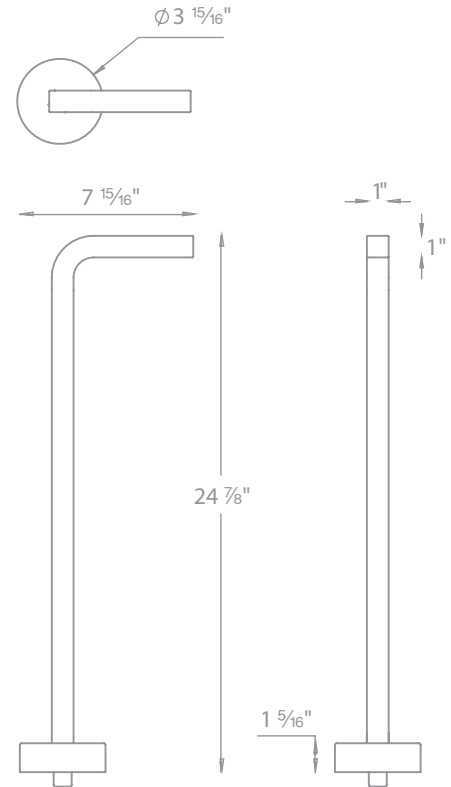

Input	Power	Brightness	CRI	Rated Life
15VAC	7W / 10VA	White Red Green Blue	310lm 110lm 205lm 45lm	85 50,000 hours

Ordering Chart

15V	Fixture Finish Options:
6861-CS	BK Black on Aluminum BZ Bronze on Aluminum

Example: **6861-CSBZ**

See Accessories page for more detail
Colorscaping Smart Transformer is required
9" Mounting stake, 6' lead wire and
direct-burial gel-filled wire nuts included

Accessories

9" Mounting Stake	14" Mounting Stake	Surface Mount Flange/Stake	Guardian Mount
9000-ST9-BZ	9000-ST14-BZ	5000-SCP-BK 5000-SCP-BZ	9000-SP9-BZ







PATENTED

LEDGE

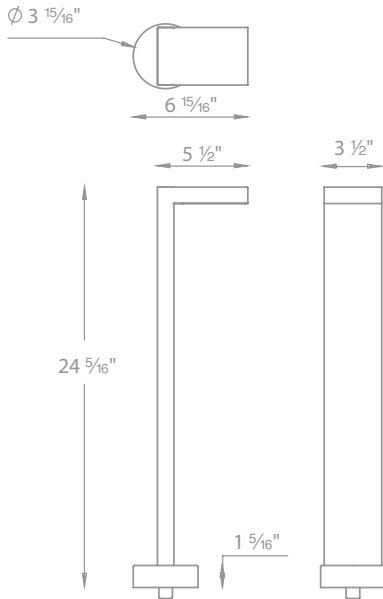

A refined vertical profile delivers precise, downward illumination that defines pathways with clarity and restraint. Designed for visual comfort and durability, this fixture offers tunable white and full-color output, individual fixture control, and coordinated operation for scene-based and time-driven lighting.

- Refined linear geometry creates a strong architectural presence without visual clutter
- Fixtures can be individually controlled in addition to grouping, scheduling and automations
- Full white light tunability from 2700K to 6500K
- Fixtures can generate millions of colors

Input	Power	Brightness	CRI	Rated Life	
15VAC	7W / 10VA	White	230lm	85	50,000 hours
		Red	80lm		
		Green	150lm		
		Blue	30lm		

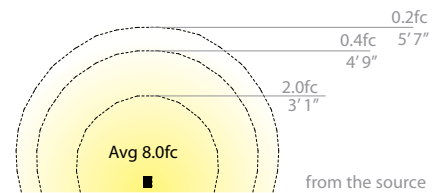

Accessories

9" Mounting Stake	14" Mounting Stake	Surface Mount Flange/Stake	Guardian Mount
9000-ST9-BZ	9000-ST14-BZ	5000-SCP-BK 5000-SCP-BZ	9000-SP9-BZ

Ordering Chart

15V	Fixture Finish Options:
6881-CS	BK Black on Aluminum BZ Bronze on Aluminum

Example: **6881-CSBZ**
 Colorscape Smart Transformer is required
 See Accessories page for more detail
 14" Mounting stake, 6' lead wire and direct-burial gel-filled wire nuts included

TIKI



A broad, downward distribution provides comfortable area illumination for pathways, landscapes, and gathering spaces. Featuring tunable white and full-color output, this fixture supports individual addressing and intuitive control for coordinated scenes and time-based lighting, with visual comfort in mind.

- Sturdy center mount design works well in applications where area illumination is desired
- Fixtures can be individually controlled in addition to grouping, scheduling and automations
- Full white light tunability from 2700K to 6500K
- Fixtures can generate millions of colors

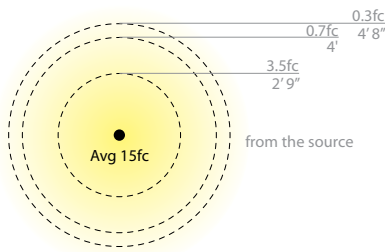

c US
1838 listed

IP66

PATENTED

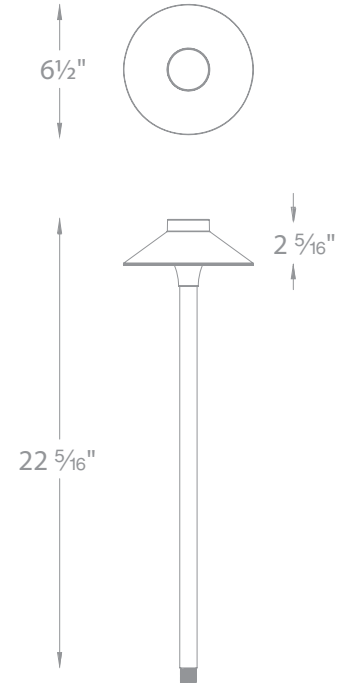

Input	Power	Brightness	CRI	Rated Life
15VAC	12W / 18.5VA	White Red Green Blue	675lm 230lm 450lm 100lm	85 50,000 hours

Ordering Chart

15V

Fixture Finish Options:

6841-CS

- BK** Black on Aluminum
- BZ** Bronze on Aluminum
- BBR** Bronze on Brass

Example: **6841-CSBZ**

Colorscaping Smart Transformer is required
See Accessories page for more detail
9" Mounting stake, 6' lead wire and
direct-burial gel-filled wire nuts included

Accessories

9" Mounting Stake	14" Mounting Stake	Surface Mount Flange/Stake	Guardian Mount
9000-ST9-BZ	9000-ST14-BZ	5000-SCP-BK 5000-SCP-BZ 5000-SCP-BBR	9000-SP9-BZ







PATENTED

CYLINDER WALL MOUNT UP AND DOWN LIGHT



A compact cylindrical profile creates controlled up-and-down illumination that adds depth and definition to exterior walls. With tunable white and full-color output, this fixture allows individual control and precise coordination for scene-based and time-driven façade lighting.

- Fixtures can be individually controlled in addition to grouping, scheduling and automations
- Select up light, down light or both via MyWAC app
- Full white light tunability from 2700K to 6500K
- Fixtures can generate millions of colors

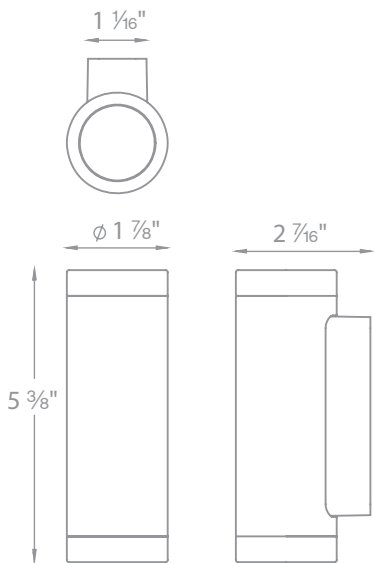

Input	Power	Brightness	Beam Angle	CRI	Rated Life
15VAC	7W / 10VA	White Red Green Blue	160lm 60lm 150lm 30lm	80°	85 50,000 hours

Ordering Chart

15V

Fixture Finish Options:

3911-CS

- BK** Black on Aluminum
- BZ** Bronze on Aluminum
- WT** White on Aluminum

Example: **3911-CSBZ**

Colorscape Smart Transformer is required
10' lead wire and gel-filled wire nuts included

HARDSCAPE

c **UL** US
1838 listed



IP66

PATENTED

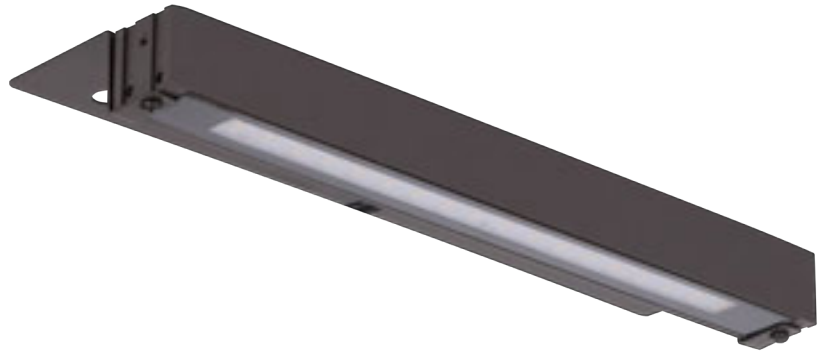

A slim, linear form delivers clean, even illumination for steps, walls, and hardscape details. Designed for seamless integration into architectural surfaces, this fixture offers tunable white and full color output, individual control, and coordinated operation for scene-based and time-driven outdoor lighting.

- Quick Release connection at fixture to easily detach from capstone bracket after installation
- Fixtures can be grouped and controlled together
- Fixtures contain discreet warm, and cool white LEDs for full tunability
- Fixtures can generate millions of colors



Input	Power	Brightness	Beam Angle	CRI	Rated Life
7 Inch					
15VAC	7W / 10VA	White 400lm	100°	85	50,000 hours
		Red 125lm			
		Green 270lm			
		Blue 60lm			

12 Inch					
15VAC	15W / 22VA	White 825lm	100°	85	50,000 hours
		Red 275lm			
		Green 550lm			
		Blue 120lm			

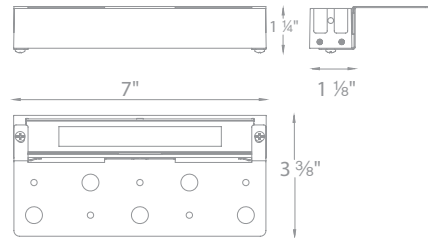

7872-CS

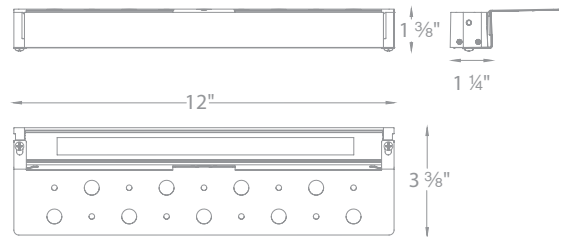

7822-CS

Fixture Finish Options:

- BK** Black on Aluminum
- BZ** Bronze on Aluminum
- BBR** Bronze on Brass

Example: **7872-CSBZ**

Colorscaping Smart Transformer is required
6' lead wire and direct-burial gel-filled wire nuts included





UL US
1838 listed

IP67

PATENTED

STEP LIGHT



A compact, recessed form delivers controlled illumination for steps, stairs, and transitions, enhancing safety without visual clutter. Designed for durability and precision, this fixture offers tunable white and full-color output with individual control for coordinated, time-driven lighting effects.

- Fixture can withstand being submerged in water up to 3 feet for up to 30 minutes
- Fixture can be individually controlled in addition to grouping, scheduling and automations
- Full white light tunability from 2700K to 6500K
- Fixture can generate millions of colors

Input	Power	Brightness	Beam Angle	CRI	Rated Life	
15VAC	5W / 6VA	White	77lm	85° x 40°	85	50,000 hours
		Red	23lm			
		Green	59lm			
		Blue	12lm			

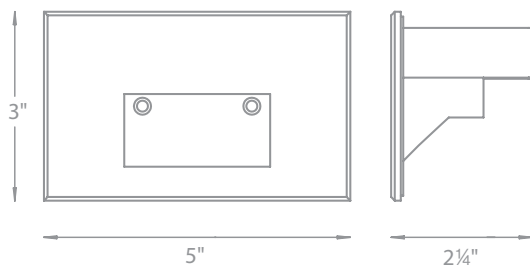

Ordering Chart

15V	Fixture Finish Options:
4011-CS	BK Black on Aluminum
	BZ Bronze on Aluminum
	BBR Bronze on Brass
	SS Cast Stainless Steel
	WT White on Aluminum

Example: **4011-CSSS**
Colorscaping Smart Transformer is required
Gel-filled wire nuts included



Fixture Finish Options:

BS Bronze Stainless Steel
SS Stainless Steel

Example: **2081-CSBS**

Colorscaping Smart Transformer is required
 Optional spring clip accessory included
 See Accessories page for more detail

Accessories

2" Concrete Pour Kit

2000-CON-PVC

	Input	Power	Brightness	Beam Angle	CRI	Rated Life
2011-CS	15VAC	4.5W / 5.5VA	White	80°	85	50,000 hours
2021-CS			Red			
2051-CS			Green Blue			
2071-CS	15VAC	4.5W / 5.5VA	White Red Green Blue	100°	85	50,000 hours
2081-CS	15VAC	4.5W / 5.5VA	White Red Green Blue	300°	85	50,000 hours
2091-CS	15VAC	4.5W / 5.5VA	White Red Green Blue	200°	85	50,000 hours
2101-CS	15VAC	4.5W / 5.5VA	White Red Green Blue	180°	85	50,000 hours
2111-CS	15VAC	4.5W / 5.5VA	White Red Green Blue	70°	85	50,000 hours
2121-CS	15VAC	4.5W / 5.5VA	White Red Green Blue	70°	85	50,000 hours
2131-CS	15VAC	4.5W / 5.5VA	White Red Green Blue	80°	85	50,000 hours



PATENTED

2" INDICATOR LIGHTS



Compact and discreet, these indicator lights provide subtle illumination for wayfinding, edges, and transitions. Designed to blend into architectural surfaces, they offer tunable white and full-color output with individual control, supporting coordinated, time-driven lighting cues with visual restraint.

- Factory-sealed, watertight fixture
- Solid stainless steel construction
- Available concrete pour kit with 18" PVC pipe which can be field shortened
- Optional spring clip accessory included
- 6' Lead Wire included

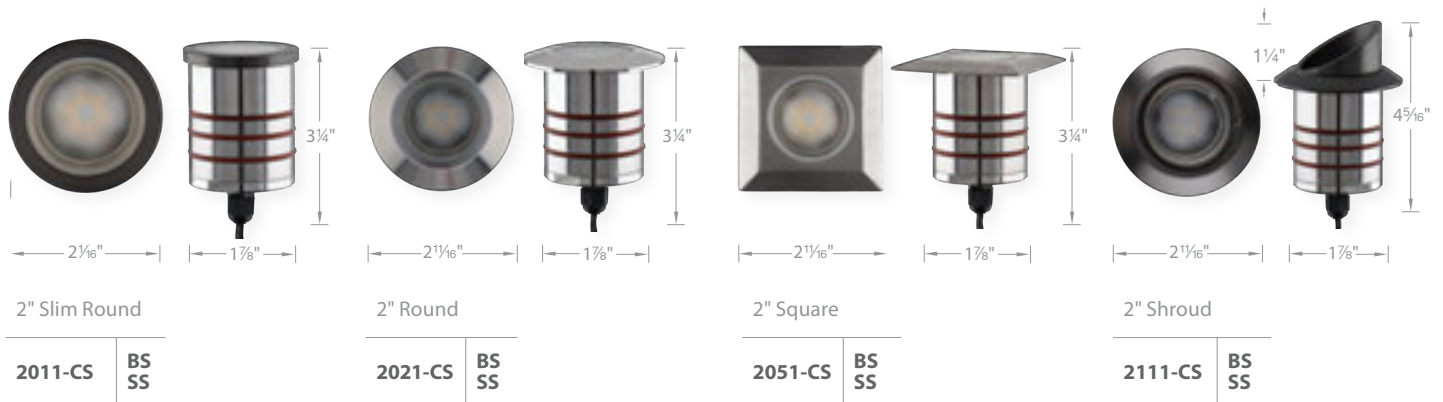
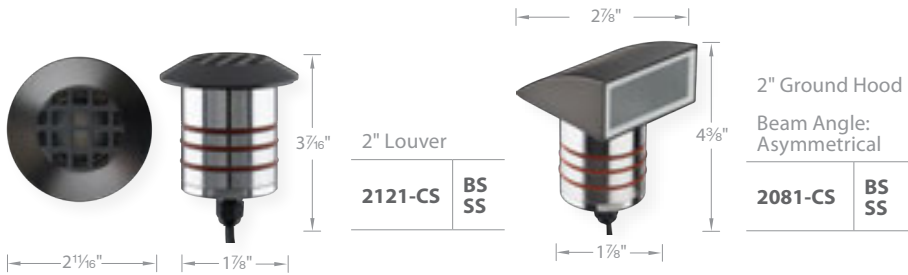





PATENTED NEW FOR 2026

UNDERWATER SPOT SS



This fully submersible stainless-steel spotlight delivers vibrant, tunable illumination underwater, ideal for ponds, fountains, and wet-area features. Its long lead wire, watertight construction, and easy-mount accessory make installation simple in both submerged and surface applications.

- Can be grouped and controlled together
- Contain discrete warm and cool white LEDs for full tunability
- Can generate tens of thousands of different colors
- Fixtures from multiple transformers can be controlled as a single group in the app

Input	Power	Brightness	Beam Angle	CRI	Rated Life
15VAC	4.5W / 5.5VA	White 230lm Red 60lm Green 155lm Blue 30lm	80°	85	50,000 hours



Includes stainless steel easy mount accessory for use with underwater applications and above ground on any surface

Designed for underwater or wet application
30ft long lead wire

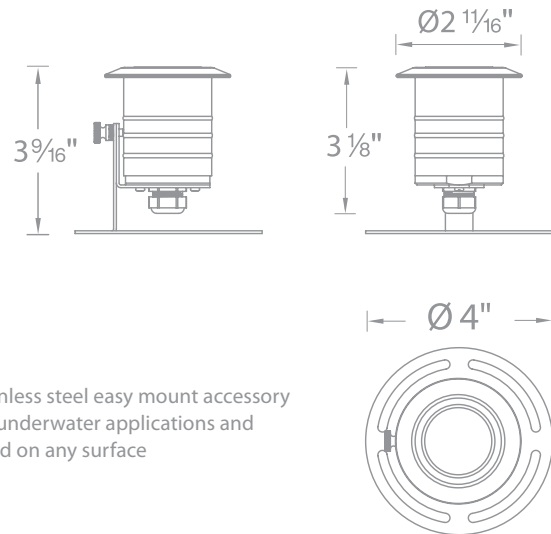

Ordering Chart

15V	Fixture Finish Options:
2031-CS	SS Stainless Steel

Example: **2031-CSSS**
Colorscaping Smart Transformer is required

UNDERWATER SPOT NB

NEW FOR 2026 PATENTED



Built from solid cast brass, this underwater spotlight adds timeless durability and warm architectural presence to fountains, ponds, and shallow water features. Factory-sealed for long-term reliability, it provides bright, tunable illumination for tailored underwater effects.

- Machined brass thumb screws
- Cast brass construction
- Underwater in depths up to 3'
- Factory-sealed, watertight fixture
- 30' long lead wire
- Limited lifetime warranty



Input	Power	Brightness		Beam Angle	CRI	Rated Life
15VAC	10.5W / 11VA	White	400lm	55°	85	50,000 hours
		Red	180lm			
		Green	335lm			
		Blue	60lm			

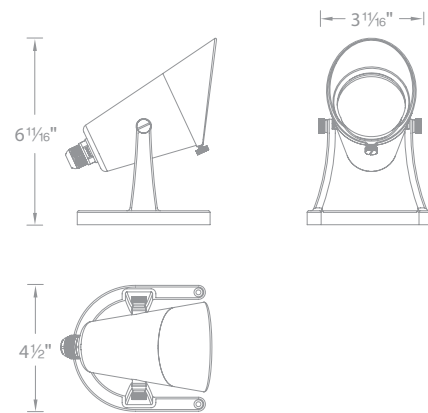

Ordering Chart

15V	Fixture Finish Options:	
5511-CS	NB	Natural Brass

Example: **5511-CSNB**
 Detachable shroud and direct-burial gel-filled wire nuts
 Colorscaping Smart Transformer is required

Accessories

Optics	
LENS-20-FR	Frosted Lens
LENS-20-SPR	Beam Spread Lens





cUL US
1838 listed

IP66

ADA

PATENTED NEW FOR 2026

DECK & PATIO



Designed for steps, decks, and railing applications, this low-profile luminaire casts a soft, diffused glow that enhances safety and ambiance. Durable metal construction and included gel filled wire nuts ensure fast, reliable installation in outdoor environments.

- Translucent lens provides for uniform diffused light output
- Solid die-cast brass or corrosion resistant aluminum alloy
- 10' lead wire and direct-burial gel-filled wire nuts included

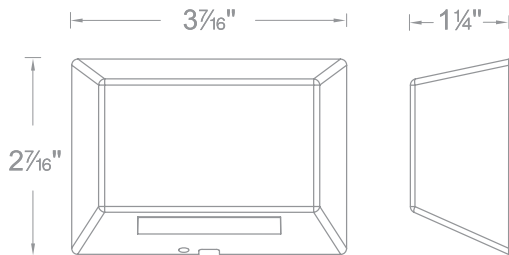

Input	Power	Brightness	CRI	Rated Life	
15VAC	2.8W / 4.0VA	White	80lm	85	50,000 hours
		Red	19lm		
		Green	60lm		
		Blue	10lm		

Ordering Chart

15V

Fixture Finish Options:

3051-CS

BK Black on Aluminum
BZ Bronze on Aluminum
BBR Bronze on Brass
WT White on Aluminum

Example: **3051-CSBK**

Colorscaping Smart Transformer Required

Flexible and discreet, this tape light delivers vivid, continuous illumination for architectural accents and concealed applications. Designed for precision and reliability, it offers tunable white and full-color output, cut-to-length flexibility, and responsive control for coordinated, time-driven lighting effects.

- Weatherproof resilience for all conditions
- Vivid full color spectrum
- Precisely tunable white light for perfect ambiance
- Effortless connectivity: plug and play connectors offer easy integration and hassle-free installation
- Comprehensive smart home system compatibility
- For custom lengths in the field, cut every 2" and seal with end caps



Ordering Chart

24VDC	Finish:	Input	Max Power	Lm/ft	Color Temp	CRI	Rated Life
01 1 foot	CC White	24VDC	3.57W/Ft 5.5W/Ft	White	R/G/B 2700K-5000K	90	50,000 hours
05 5 feet				Red			
T24-OD1 10 10 feet				Green			
15 15 feet				Blue			
25 25 feet							

Example: **T24-OD1-01-CC**

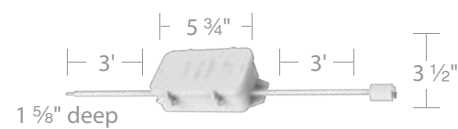

Controller	Input	Output	IP
915CS-CTR-WT	9-15VAC	24VDC/96W MAX 11W/17VA	IP65

A controller is required for the tape light to function with the Colorscaping Transformer

Example: **915CS-CTR-WT**

Max Run Tape Length Between Controller & Tape

Total Length of Lead Wire Between Controller & Tape	Colorscape Transformer & MyWAC App
3ft	25ft
6ft	25ft
9ft	25ft
12ft	22ft
18ft	15ft
24ft	12ft
30ft	10ft
40ft	7ft

Based on a 3 ft lead wire between transformer and controller.

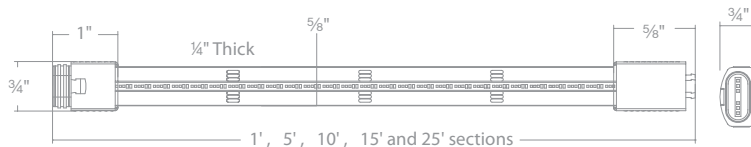

System Configuration



MyWAC App



Wallstation



Colorscaping Transformer
8150CS-TRN-SS (150W)
8300CS-TRN-SS (300W)

+



Linear RGBWW Controller
915CS-CTR-WT



RGBWW Tape

To achieve longer run lengths between the Colorscaping transformer and the tape light, it is recommended to use a 12 AWG wire extension cable between the Colorscaping transformer and the beginning of the Linear RGBWW Controller to minimize voltage drop.

Accessories

Joiner Cable	L&J Connector	Y Connector	X Connector	End Cap	5' Clear Channel	Surface Mounting Clip	Edge Mounting Clip
T24-OD-IC6-WT T24-OD-IC12-WT T24-OD-IC72-WT T24-OD-IC120-WT	T24-OD-L-WT	T24-OD-Y-WT	T24-OD-X-WT	T24-OD-EC-WT	T24-OD-CH5-CL	T24-OD-C1-WT	T24-OD-C2-WT

Underside Mounting Clip



















T24-OD-C3-WT

See Accessories page for more detail











ACCESSORIES

MOUNTING + GLARE CONTROL

9" Mounting Stake		9000-ST9-BZ	Bronze	Durable PC stake.
14" Mounting Stake		9000-ST14-BZ	Bronze	Durable PC stake.
Surface Mount Flange/Stake		5000-SCP-BK 5000-SCP-BZ 5000-SCP-BBR	Black on Aluminum Bronze on Aluminum Bronze on Brass	Includes three 7 inch threaded stainless steel stabilizing pins for ground mounting or surface mounts with four screws or over a junction box.
Guardian Mount		9000-SP9-BZ	Stainless Steel	Heavy duty stainless steel spike to position fixture.
Accent Snoot		5010-SNOOT-BK 5010-SNOOT-BZ 5010-SNOOT-BBR	Black on Aluminum Bronze on Aluminum Bronze on Brass	Shields lamp and reduces glare.
Grand Accent Snoot		5211-SNOOT-BK 5211-SNOOT-BZ 5211-SNOOT-BBR	Black on Aluminum Bronze on Aluminum Bronze on Brass	Shields lamp and reduces glare.
Accent Long Shroud		5010-LSHR-BK 5010-LSHR-BZ 5010-LSHR-BBR	Black on Aluminum Bronze on Aluminum Bronze on Brass	Reduce glare. Ideal for downlighting application.
Grand Accent Long Shroud		5211-LSHR-BK 5211-LSHR-BZ 5211-LSHR-BBR	Black on Aluminum Bronze on Aluminum Bronze on Brass	Reduce glare. Ideal for downlighting application.
Accent Honeycomb Louver		5011-HCL	Black	Reduces glare and softens brightness for refined light distribution.
Grand Accent Honeycomb Louver		5211-HCL	Black	Reduces glare and softens brightness for refined light distribution.
Gutter Mount Bracket		5000-GM-BZ 5000-GM-BK	Stainless Steel	Stainless Steel universal mounting bracket for gutter mounting fixture.
Tree Mount Junction Box		5000-TCP-BK 5000-TCP-BZ	Black on Aluminum Bronze on Aluminum	Bronze on Aluminum box with Stainless steel mounting screws. Two 1/2" NPT threaded holes.
Extension Rods		5000-X04-BZ 4 in 5000-X04-BK 4 in 5000-X04-BBR 4 in 5000-X08-BZ 8 in 5000-X08-BK 8 in 5000-X08-BBR 8 in 5000-X12-BZ 12 in 5000-X12-BK 12 in 5000-X12-BBR 12 in	5000-X18-BZ 18 in 5000-X18-BK 18 in 5000-X18-BBR 18 in 5000-X24-BZ 24 in 5000-X24-BK 24 in 5000-X24-BBR 24 in	Extends distance between Accent light and Surface Mount Canopy, Stake, or Tree Mount box.
Rod L-Coupler		5000-LCO-BK 5000-LCO-BZ	Black Bronze	Extension rod coupler.
Rock Guard		5830-GRD-BZ 5830-GRD-BBR	Bronze on Aluminum Bronze on Brass	Protects the fixture face.
Anti-Glare Shroud		5033-SHR-BZ 5033-SHR-BBR	Bronze on Aluminum Bronze on Brass	Reduces glare.
Concrete Pour Kit		5830-PIP-PVC	Shown with temporary dense foam cap	For installation in concrete Five 1/2" NPT threaded holes, PVC.
2" Concrete Pour Kit		2000-CON-PVC	Black	For installation in concrete. 18" PVC pipe included. installs onto a 4" outdoor rated junction box.

TAPE LIGHT

	5' Clear Channel	T24-OD-CH5-CL	5 feet Includes mounting hardware.
	Invisible Clip	T24-OD-C3-WT	Spring clip secures beneath tape. (10pcs)
	Surface Mounting Clip	T24-OD-C1-WT	For installation on non-flat surfaces where there is no edge contact. (10pcs/pack)
	Edge Mounting Clip	T24-OD-C2-WT	For installation on non-flat surfaces, allows for contact on one edge. (10 pcs/pack)
	L & J Connector	T24-OD-L-WT	90 Degree Angle Connection
	End Cap	T24-OD-EC-WT	Seal cut end with silicone after adding end cap
	Joiner Cable	T24-OD-IC6-WT 6 inch T24-OD-IC12-WT 1 foot T24-OD-IC72-WT 6 feet T24-OD-IC120-WT 10 feet	Connects between tape sections, Extends power supply lead wire.
	4 Way "X" Connector	T24-OD-X-WT	4 - Way extension. (1 Male end, 3 Female)
	3 Way "Y" Connector	T24-OD-Y-WT	3 - Way extension. (1 Male, 2 Female)

COLORSCAPING TRANSFORMER

	Smart Magnetic Transformer	150W MAX: 8150CS-TRN-SS 300W MAX: 8300CS-TRN-SS	Stainless Steel, 15VAC output, IP65 rated, UL 1838 listed.
---	----------------------------	--	---

WALLSTATION

	Scene Dimming Wallstation	LED-WCT-WT	Easy installation and a simple way to control lighting. The sleek, aesthetic designs are suitable for all interior locations. Wi-Fi required.
---	---------------------------	-------------------	---

WARRANTY

Landscape Products, as defined by products offered at www.waclighting.com/landscape, carry a 10 year warranty on low voltage electronics, 5 years on 120V electronics, 5 years on outdoor finishes on aluminum housings, 10 years on outdoor finishes on brass housings, lifetime on stainless steel, under normal use.

Visit www.waclighting.com/warranty for full warranty information.





WAC LIGHTING®

LANDSCAPE SOLUTIONS

Clean light reveals the landscape as it is meant to be seen, quiet, intentional, and timeless. Available in 12V, 120V, and 277V, each fixture features on board output adjustment and in-field beam control for precise shaping as the landscape evolves.

GRAND ACCENT

PATENTED



IP66



1838 listed
1598 listed

MOONLIGHTING EFFECT

Designed to replicate the natural effect of moonlight, this high-output accent fixture delivers soft, downward illumination from elevated mounting positions. With precise beam control, tunable white output, and individual fixture control, it creates layered, naturalistic lighting across landscapes and tree canopies.



- 4000K color temperature option resembles moonlight
- Adjustable beam 15° to 60°
- Continuously adjustable lumen output 740–2,000 lm
- Integral brightness control
- One fixture replaces various higher wattage halogen accent lights

Input	Power	Brightness	Beam Angle	Color Temp	CRI	Rated Life
12V						
9 - 15VAC	15W - 33W 21VA - 43VA	740lm - 2000lm	15° - 60°	2700K, 3000K, 4000K	85	45,000 hours
Transformer Required (order separately)						
120V						
120VAC	13W - 31W	780lm - 2050lm	15° - 60°	3000K, 4000K	85	45,000 hours

See photometric data on page 155 / 156

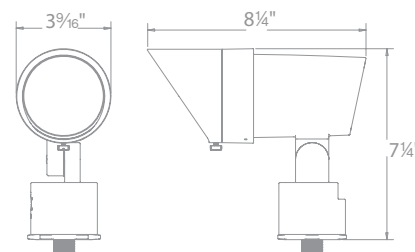

Ordering Chart

12V	120V	Fixture Finish Options:	
5211-27	5212-30 5212-40	BK	Black on Aluminum
5211-30		BZ	Bronze on Aluminum
5211-40		BBR	Bronze on Brass

Example: **5211-30BK**

See Accessories page for more detail
9" Mounting stake (12V), detachable shroud, 6' lead wire and direct-burial gel-filled wire nuts (12V) included

Accessories

Large Tree Mount Canopy Strap	Extension Rods	Optics
5000-TST-BK 5000-STB-BK	5000-X04-BZ,BK,BBR 5000-X08-BZ,BK,BBR 5000-X12-BZ,BK,BBR 5000-X18-BZ,BK,BBR 5000-X24-BZ,BK,BBR	LENS-25-AMB LENS-25-GRN LENS-25-RED LENS-25-BLU LENS-25-FR LENS-25-SPR LENS-25-BEL 5211-HCL

5" Long Shroud	Grand Accent Snoot	Mounting Stake	Power Stake	Surface Mount Flange/Stake	Guardian Mount	Gutter Mount Bracket	Tree Mount Junction Box
5211-LSHR-BK 5211-LSHR-BZ 5211-LSHR-BBR	5211-SNOOT-BK 5211-SNOOT-BZ 5211-SNOOT-BBR	9000-ST9-BZ 9000-ST14-BZ	M6000-STAKE	5000-SCP-BK 5000-SCP-BZ 5000-SCP-BBR	9000-SP9-BZ	5000-GM-BK 5000-GM-BZ	5000-TCP-BK 5000-TCP-BZ 5000-TCL-BK 5000-TCL-BZ





UL US
1838 listed
1598 listed

IP66

PATENTED

ACCENT



Compact and versatile, this accent fixture delivers precise illumination with adjustable beam control for landscape and architectural details. Offering tunable white output, it supports individual fixture control and coordinated operation for refined, time-driven outdoor lighting.

12V

- Both fixture level dimming and circuit level dimming
- Dim each circuit from either the 12V or 120V side
- Adjustable beam angle 10° to 60°

120V

- Adjustable beam angle 15° to 60°
- Simple to retrofit existing line voltage systems or coordinate well with a new commercial landscape job

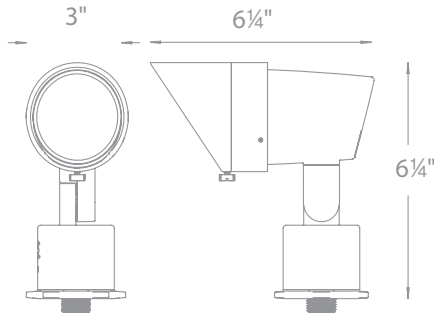

Input	Power	Brightness	Beam Angle	Color Temp	CRI	Rated Life
12V						
9 - 15VAC	1W - 18W 2VA - 23VA	50lm - 1160lm	10° - 60°	2700K, 3000K, 4000K	85	70,000 hours
120V						
110V - 120VAC	3.5W - 14.5W	100lm - 900lm	15° - 60°	3000K	85	45,000 hours

See photometric data on page 157 / 158

Accessories

Large Tree Mount Canopy Strap	Extension Rods	Optics
5000-TST-BK 5000-STB-BK	5000-X04-BZ,BK,BBR 5000-X08-BZ,BK,BBR 5000-X12-BZ,BK,BBR 5000-X18-BZ,BK,BBR 5000-X24-BZ,BK,BBR	LENS-20-AMB LENS-20-GRN LENS-20-RED LENS-20-BLU LENS-20-FR LENS-20-SPR LENS-20-BEL 5011-HCL

Ordering Chart

12V	120V	Fixture Finish Options:	
5011-27 5011-30 5011-40	5012-30	BK BZ BBR	Black on Aluminum Bronze on Aluminum Bronze on Brass

Example: **5011-30BZ**
See Accessories page for more detail
Transformer Required (order separately)
9" Mounting stake (12V), detachable shroud, 6' lead wire and direct-burial gel-filled wire nuts (12V) included

6" Long Shroud	Accent Snoot	Mounting Stake	Power Stake	Surface Mount Flange/Stake	Guardian Mount	Gutter Mount Bracket	Tree Mount Junction Box
5010-LSHR-BK 5010-LSHR-BZ 5010-LSHR-BBR	5010-SNOOT-BK 5010-SNOOT-BZ 5010-SNOOT-BBR	9000-ST9-BZ 9000-ST14-BZ	M6000-STAKE	5000-SCP-BK 5000-SCP-BZ 5000-SCP-BBR	9000-SP9-BZ	5000-GM-BK 5000-GM-BZ	5000-TCP-BK 5000-TCP-BZ 5000-TCL-BK 5000-TCL-BZ

MINI ACCENT

PATENTED



Compact and precise, this mini accent fixture delivers focused illumination for subtle landscape and architectural details. With adjustable beam control and tunable white output, it supports individual fixture control and refined, time-driven lighting for smaller-scale applications.



- Integral brightness control
- Adjustable beam angle 10° to 50°
- One fixture replaces various halogen accent lights.

Input	Power	Brightness	Beam Angle	Color Temp	CRI	Rated Life
9 - 15VAC	1W - 7W 2.5VA - 7.6VA	45lm - 365lm	10° - 50°	2700K, 3000K	85	70,000 hours

See photometric data on page 159

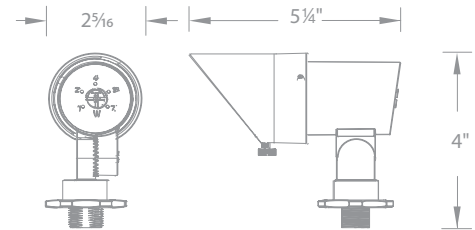

Single and Double stem mount available. See next page



Shown with gutter mount bracket accessory



Continuously adjustable brightness control

Ordering Chart

12V	Fixture Finish Options:	Accessories			
5111-27 5111-30	BK BZ BBR WT	Large Tree Mount Canopy Strap	Extension Rods	Optics	5" Long Shroud
	Black on Aluminum Bronze on Aluminum Bronze on Brass White on Aluminum	5000-TST-BK 5000-STB-BK	5000-X04-BZ,BK,BBR 5000-X08-BZ,BK,BBR 5000-X12-BZ,BK,BBR 5000-X18-BZ,BK,BBR 5000-X24-BZ,BK,BBR	LENS-16-AMB LENS-16-GRN LENS-16-RED LENS-16-BLU LENS-16-FR LENS-16-SPR LENS-16-BEL 5111-HCL	5111-LSHR-BK 5111-LSHR-BZ 5111-LSHR-BBR
Example: 5111-30BZ See Accessories page for more detail Transformer Required (order separately) 9" Mounting stake (12V), detachable shroud, 6' lead wire and direct-burial gel-filled wire nuts (12V) included					

Mini Accent Snoot	Mounting Stake	Power Stake	Surface Mount Flange/Stake	Guardian Mount	Gutter Mount Bracket	Tree Mount Junction Box
5111-SNOOT-BK 5111-SNOOT-BZ 5111-SNOOT-BBR	9000-ST9-BZ 9000-ST14-BZ	M6000-STAKE	5000-SCP-BK 5000-SCP-BZ 5000-SCP-BBR	9000-SP9-BZ	5000-GM-BK 5000-GM-BZ	5000-TCP-BK 5000-TCP-BZ 5000-TCL-BK 5000-TCL-BZ



PATENTED

MINI ACCENT

A slender, elevated profile positions light precisely where it is needed for targeted accenting. Featuring adjustable aiming, tunable white output, and individual fixture control, this mini accent is ideal for highlighting plantings and details with controlled, unobtrusive illumination.

- Includes 6", 12" and 24" extensions
- 10°-50° beam adjustability
- Continuously adjustable beam angles and brightness control
- Detachable shroud
- Constant output for 9V-15V input



6111

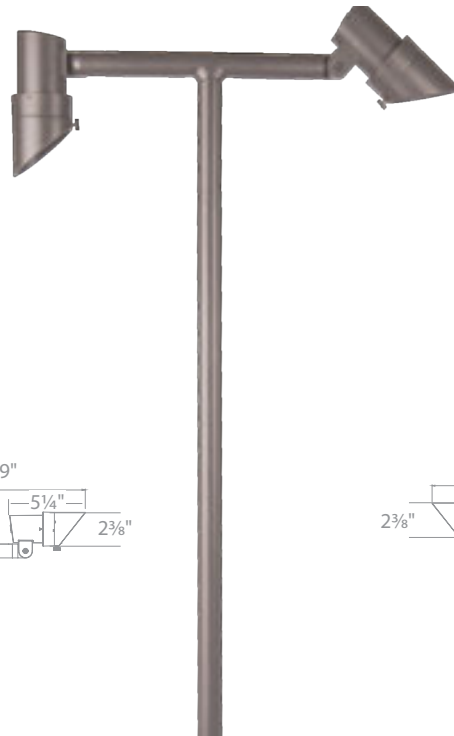
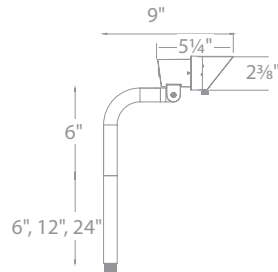

6211

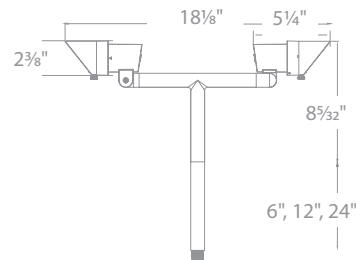

Input	Power	Brightness	Color Temp	CRI	Rated Life
9 - 15VAC	1W - 7W 2.5VA - 7.6VA	45lm - 365lm	2700K, 3000K	85	70,000 hours
9 - 15VAC	1W - 7W x2 2.5VA - 7.6VA x2	45lm - 365lm x2	2700K, 3000K	85	70,000 hours

See photometric data on page 159

Accessories

5" Long Shroud	14" Mounting Stake	Surface Mount Flange/Stake	Guardian Mount
5111-LSHR-BZ 5111-LSHR-BBR	9000-ST14-BZ	5000-SCP-BK 5000-SCP-BZ 5000-SCP-BBR	9000-SP9-BZ

Ordering Chart

Single	Double	Fixture Finish Options:	
6111-27 6111-30	6211-27 6211-30	BZ	Bronze on Aluminum
		BBR	Bronze on Brass

Example: **6111-30BBR**

Example: **6211-30BBR**

Transformer Required

See Accessories page for more detail

INTERBEAM

PATENTS
PENDING

IP66



1838 listed

Designed for flexibility, this accent fixture features interchangeable optics and adjustable beam angles to adapt to a wide range of lighting needs. With tunable white output and precise aiming, it delivers consistent, controlled illumination for landscape and architectural applications.



- MLV Dimmable (remote MLV dimmer)
- Adjustable beam angle 20° to 60°
- One adjustable light replaces multiple lights with different optics, sizes and styles.

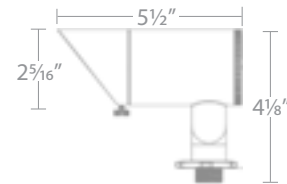

Model	Input	Power	Brightness	Beam Angle	Color Temp	CRI	Rated Life
5311	9 - 15VAC	6W / 7.7VA	475lm	20° - 60°	2700K, 3000K	85	70,000 hours
5411	9 - 15VAC	3W / 5VA	245lm	20° - 60°	2700K, 3000K	85	70,000 hours

See photometric data on page 160

Ordering Chart

12V

Fixture Finish Options:

5311-27	5411-27	BK	Black on Aluminum
5311-30	5411-30	BZ	Bronze on Aluminum

Example: **5311-30BK**
Transformer Required

See Accessories page for more detail
9" Mounting stake (12V), detachable shroud, 6' lead wire and direct-burial gel-filled wire nuts (12V) included

Large Tree Mount Canopy Strap	Extension Rods	Optics
5000-TST-BK	5000-X04-BZ,BK,BBR	LENS-16-AMB
5000-STB-BK	5000-X08-BZ,BK,BBR	LENS-16-GRN
	5000-X12-BZ,BK,BBR	LENS-16-RED
	5000-X18-BZ,BK,BBR	LENS-16-BLU
	5000-X24-BZ,BK,BBR	LENS-16-FR
		LENS-16-SPR
		LENS-16-BEL
		5111-HCL

Accessories

5" Long Shroud	Mini Accent Snoot	Mounting Stake	Power Stake	Surface Mount Flange/Stake	Guardian Mount	Gutter Mount Bracket	Tree Mount Junction Box
5111-LSHR-BK	5111-SNOOT-BK	9000-ST9-BZ	M6000-STAKE	5000-SCP-BK	9000-SP9-BZ	5000-GM-BK	5000-TCP-BK
5111-LSHR-BZ	5111-SNOOT-BZ	9000-ST14-BZ		5000-SCP-BZ		5000-GM-BZ	5000-TCP-BZ
5111-LSHR-BBR	5111-SNOOT-BBR			5000-SCP-BBR			5000-TCL-BK
							5000-TCL-BZ







HORNET



Compact and durable, this accent fixture delivers focused illumination with adjustable beam control for precise landscape and architectural highlighting. Featuring tunable white output and accurate aiming, it provides reliable performance for demanding outdoor applications.

- Solid die-cast brass construction with factory-sealed, water-tight design for long-term outdoor durability
- Adjustable, lockable beam angle delivers precise illumination from a compact, high-output form factor
- Consistent lumen output maintained across voltage drops with remote MLV dimming capability
- Versatile mounting options for ground or wall applications, with direct burial gel-filled wire included

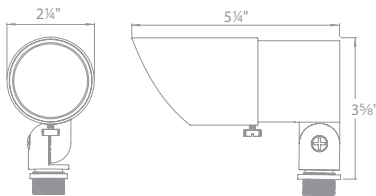

Input	Power	Brightness	Beam Angle	Color Temp	CRI	Rated Life
9 - 15VAC	10.5W / 15VA	820lm	20° - 70°	2700K, 3000K	85	45,000 hours

See photometric data on page 160

Accessories

9" Mounting Stake	Surface Mount Flange/Stake	Gutter Mount Bracket	Tree Mount Junction Box	Large Tree Mount Canopy Strap
9000-ST9-BZ	5000-SCP-BK 5000-SCP-BZ 5000-SCP-BBR	5000-GM-BK 5000-GM-BZ	5000-TCP-BK 5000-TCP-BZ 5000-TCL-BK 5000-TCL-BZ	5000-TST-BK 5000-STB-BK

Ordering Chart

12V	Fixture Finish Options:
5611-27 5611-30	BBR Bronze on Brass

Example: **5611-30BBR**
See Accessories page for more detail
Transformer Required
9" Mounting stake included
12' lead wire and direct-burial gel-filled wire nuts included

ADJUSTABLE BEAM WALL WASH

PATENTED



1838 listed
1598 listed

Designed for precise vertical illumination, this adjustable wall wash offers selectable beam distributions and integrated brightness control for refined architectural lighting. With flexible aiming, it delivers controlled, even washes across façades, walls, and landscape elements.

- Continuously adjustable NEMA beam distribution 3x4 (35°x60°), 4x5 (60°x90°), 5x6 (90°x120°)
- Integral brightness control
- Rotatable fixture head for vertical distribution
- Solid die-cast brass or corrosion resistant aluminum alloy
- Simple to retrofit existing line voltage systems or coordinate well with a new commercial landscape job



Input	Power	Brightness	Beam Angle	Color Temp	CRI	Rated Life
12V						
9 - 15VAC	3W - 25W 6VA - 34VA	200lm - 1500lm	Assorted NEMA distributions	2700K, 3000K	85	70,000 hours
Transformer Required (order separately)						
120V						
110V - 120VAC	3W - 24W	200lm - 1550lm	Assorted NEMA distributions	2700K, 3000K	85	45,000 hours

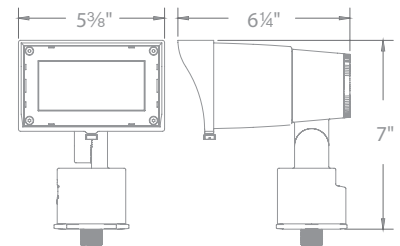

See photometric data on page 161

Ordering Chart		Fixture Finish Options:	
12V	120V		
5221-27 5221-30	5222-27 5222-30	BK	Black on Aluminum
		BZ	Bronze on Aluminum
		BBR	Bronze on Brass

Example: **5221-30BK**

See Accessories page for more detail
14" Mounting stake (12V), detachable shroud, 6' lead wire and direct-burial gel-filled wire nuts (12V) included

Accessories						
Mounting Stake	Surface Mount Flange/Stake	Guardian Mount	Gutter Mount Bracket	Tree Mount Junction Box	Large Tree Mount Canopy Strap	Optics
9000-ST14-BZ	5000-SCP-BK 5000-SCP-BZ 5000-SCP-BBR	9000-SP9-BZ	5000-GM-BK 5000-GM-BZ	5000-TCP-BK 5000-TCP-BZ 5000-TCL-BK 5000-TCL-BZ	5000-TST-BK 5000-STB-BK	LENS-3X5-AMB LENS-3X5-GRN LENS-3X5-RED LENS-3X5-BLU LENS-3X5-FR LENS-3X5-SPR LENS-3X5-BEL 5221-HCL



Architectural beam distributions from 3x4 to 4x5 to 5x6 proportions and everything in between. Always a uniform wide beam wash of light.



NEMA 5x4

NEMA 4x5

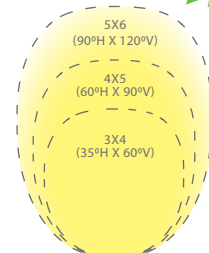
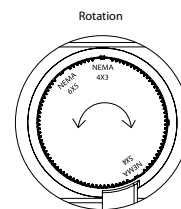
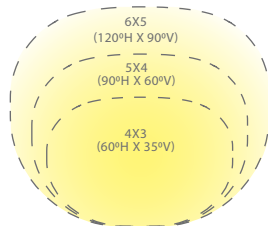
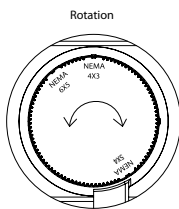

WALL WASH

PATENTED



1838 listed
1598 listed

Engineered to deliver a broad, even distribution, this wall wash fixture provides consistent vertical illumination from a compact, adjustable form. Featuring integrated brightness control, it offers precise aiming and reliable performance for architectural and landscape applications.

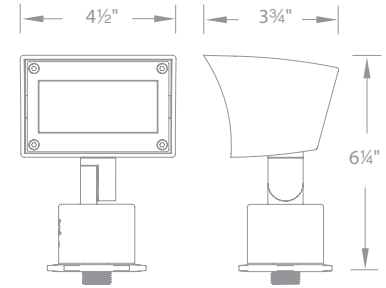

- A uniform wide distribution wall wash from a small form factor
- Solid die-cast brass or corrosion resistant aluminum alloy
- Factory sealed watertight fixtures
- Constant output for 9V-15V, 110V - 120V inputs
- Even Coverage at 15° Upwards, 50° x 80°
- Continuously Adjustable Brightness Control indexed at 1W, 4W, 8W, 13W, 18W

Input	Power	Brightness	Beam Angle	Color Temp	CRI	Rated Life
12V						
9 - 15VAC	1W - 18W 2VA - 23VA	190lm - 980lm	15° upward (50° by 80°)	2700K, 3000K	85	70,000 hours
Transformer Required (order separately)						
120V						
110V - 120VAC	3.5W - 14.5W	95lm - 855lm	15° upward (50° by 80°)	3000K	85	45,000 hours

See photometric data on page 162

Ordering Chart

12V	120V	Fixture Finish Options:	Accessories			
			Extension Rods	Rod L-Coupler	Optics	
5021-27 5021-30	5022-30	BK Black on Aluminum BZ Bronze on Aluminum BBR Bronze on Brass	5000-X04-BZ,BK,BBR 5000-X08-BZ,BK,BBR 5000-X12-BZ,BK,BBR 5000-X18-BZ,BK,BBR 5000-X24-BZ,BK,BBR	5000-LCO-BK 5000-LCO-BZ	LENS-2X4-AMB LENS-2X4-GRN LENS-2X4-RED LENS-2X4-BLU LENS-2X4-FR LENS-2X4-SPR 5021-HCL	
Example: 5021-30BK See Accessories page for more detail 9" Mounting stake (12V), 6' lead wire and direct-burial gel-filled wire nuts (12V) included						
Mounting Stake	Power Stake	Surface Mount Flange/Stake	Guardian Mount	Gutter Mount Bracket	Tree Mount Junction Box	Large Tree Mount Canopy Strap
9000-ST9-BZ 9000-ST14-BZ	M6000-STAKE	5000-SCP-BK 5000-SCP-BZ 5000-SCP-BBR	9000-SP9-BZ	5000-GM-BK 5000-GM-BZ	5000-TCP-BK 5000-TCP-BZ 5000-TCL-BK 5000-TCL-BZ	5000-TST-BK 5000-STB-BK



PATENTED

MINI WALL WASH

A compact profile delivers smooth, uniform wall washing from a smaller footprint, ideal for tighter architectural conditions. With integral brightness control, this fixture enables refined vertical illumination with precise adjustment and visual comfort.

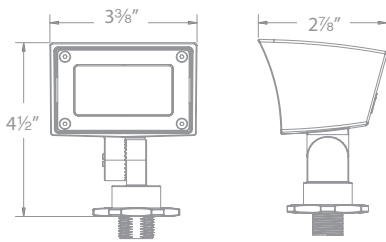

- Integral brightness control. Select color temperature option
- Mounting stake and direct burial gel filled wire nuts all included
- A uniform wide distribution wall wash from a small form factor

Input	Power	Brightness	Beam Angle	CCT	CRI	Rated Life
9 - 15VAC	1W - 8W 2VA - 12VA	80lm - 420lm	Symmetrical (70° by 90°)	2700K, 3000K	85	70,000 hours

See photometric data on page 162

Ordering Chart

12V	Fixture Finish Options:
5121-27/30	BK Black on Aluminum
	BZ Bronze on Aluminum
	BBR Bronze on Brass
	WT White on Aluminum

Example: **5121-27/30BZ**

See Accessories page for more detail
Transformer Required

9" Mounting stake (12V), 6' lead wire and direct-burial gel-filled wire nuts (12V) included

Accessories

Mounting Stake	Surface Mount Flange/Stake	Guardian Mount	Gutter Mount Bracket	Tree Mount Junction Box	Large Tree Mount Canopy Strap	Extension Rods	Optics
9000-ST9-BZ 9000-ST14-BZ	5000-SCP-BK 5000-SCP-BZ 5000-SCP-BBR	9000-SP9-BZ	5000-GM-BK 5000-GM-BZ	5000-TCP-BK 5000-TCP-BZ 5000-TCL-BK 5000-TCL-BZ	5000-TST-BK 5000-STB-BK	5000-X04-BZ,BK,BBR 5000-X08-BZ,BK,BBR 5000-X12-BZ,BK,BBR 5000-X18-BZ,BK,BBR 5000-X24-BZ,BK,BBR	LENS-2X3-AMB LENS-2X3-GRN LENS-2X3-RED LENS-2X3-BLU LENS-2X3-FR LENS-2X3-SPR LENS-2X3-BEL 5121-HCL

GRAND IN-GROUND



Built for demanding in-ground applications, this high-output fixture delivers powerful, controlled illumination with adjustable beam angles and directional aiming. Designed for durability and precision, it provides reliable performance for architectural accents, hardscape features, and landscape focal points.

- Integral brightness control
- Adjustable beam 20° to 60°
- Directional aim with +/- 20° Tilt

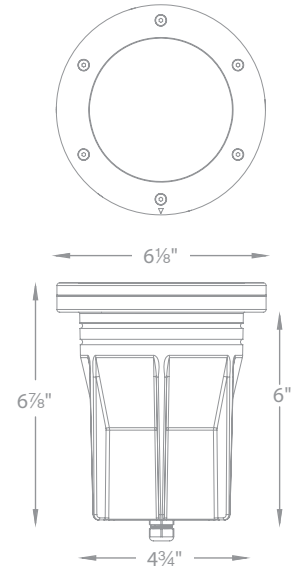

Input	Power	Brightness	Beam Angle	Color Temp	CRI	Rated Life
12V 9 - 15VAC	2W - 25W / 3VA - 33VA	105lm - 2000lm	20° to 60°	2700K, 3000K	85	55,000 hours
120V 110 - 120VAC	4W - 24W	130lm-2000lm	20° to 60°	2700K, 3000K	85	50,000 hours

See photometric data on page 163 / 164

Ordering Chart

12V	120V	Fixture Finish Options:
5033-27	5034-30	BZ Bronze on Aluminum
5033-30		BBR Bronze on Brass
Example: 5033-30BZ		
Transformer Required (order separately)		
6' lead wire and direct-burial gel-filled wire nuts (12V)		



GRAND IN-GROUND Features

Accessories		
Anti-Glare Shroud	Rock Guard	Concrete Pour Kit
5033-SHR-BZ	5830-GRD-BZ	5830-PIP-PVC
5033-SHR-BBR	5830-GRD-BBR	



1838 listed
1598 listed



IP67

PATENTED

3" IN-GROUND



A compact, low-profile in-ground fixture delivers focused illumination with adjustable beam control for precise placement. Engineered for durability and visual comfort, it offers dependable performance for architectural details, pathways, and landscape features.

- Integral brightness control
- Adjustable beam angle
- Directional aim with +/- 20° Tilt (12V ONLY)

3" In-ground Features



Control Brightness

Adjustable brightness
Presets Comparable to
10W, 25W, 35W, 50W, 75W
Halogen source



Adjust Beam Angles

Presets at 15°, 30°, 45°, 60°



Tilt and Aim

Up to 40° of adjustability preset
at -20°, -10°, 0°, 10°, 20°

Input	Power	Brightness	Beam Angle	Color Temp	CRI	Rated Life
12V						
9 - 15VAC	2W - 12W 2VA - 17VA	70lm - 505lm	15° to 60°	2700K, 3000K	85	55,000 hours
Transformer Required (order separately)						
120V						
110V - 120VAC	3W - 11.5W	65lm - 515lm	15° to 60°	3000K	85	45,000 hours

See photometric data on page 165 / 166

Ordering Chart

12V	120V	Fixture Finish Options:	
5031-27 5031-30	5032-30	BZ BBR	Bronze on Aluminum Bronze on Brass

Example: **5031-30BZ**
6' lead wire and direct-burial gel-filled
wire nuts (12V) or standard wire nuts (120V) included

Accessories

Anti-Glare Shroud	Non-Slip Lens	Rock Guard	Optics	Concrete Pour Kit
5030-SHR-BZ 5030-SHR-BBR	5030-NSLEN-CL	5030-GRD-BZ 5030-GRD-BBR	LENS-25-AMB LENS-25-GRN LENS-25-RED LENS-25-BLU LENS-25-FR LENS-25-HCL	5030-PIP-PVC



SURFACE MOUNT INDICATOR

2" APERTURE



2541-27 BS
2541-30 SS



2511-27 BS
2511-30 SS



2521-27 BS
2521-30 SS



2551-27 BS
2551-30 SS

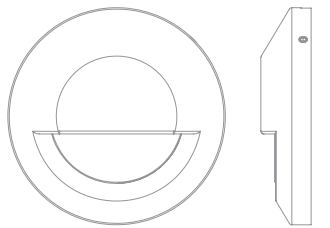

2 7/8" 1 1/16"

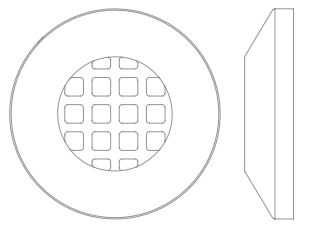

2 7/8" 1 1/16"

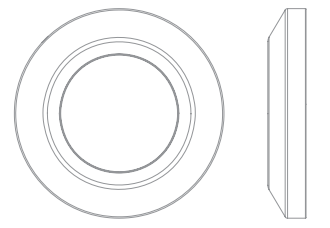

2 7/8" 1 1/16"

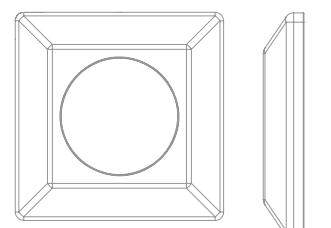

2 7/8" 1 1/16"



2591-27 BS
2591-30 SS



2571-27 BS
2571-30 SS

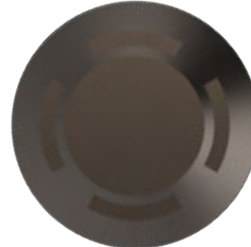

2501-27 BS
2501-30 SS



2531-27 BS
2531-30 SS

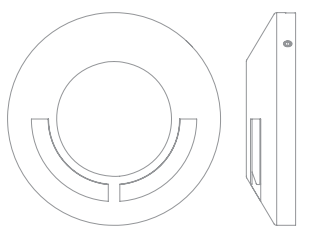

2 7/8" 1 1/16"

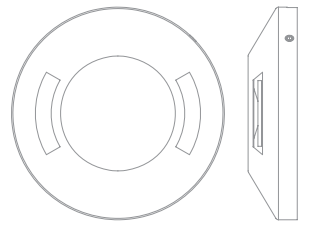

2 7/8" 1 1/16"

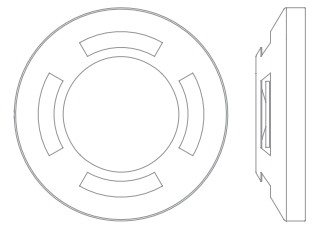

2 7/8" 1 1/16"

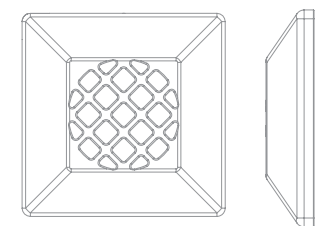

2 7/8" 5/8"

Fixture Finish Options:

BS Bronze Stainless Steel
SS Stainless Steel

Example: **2551-27SS**
Transformer Required
10' Lead Wire Included

Input	Power	Brightness	Color Temp	CRI	Rated Life
9-15VAC	3.2W - 3.5VA	3.5lm - 160lm	2700K, 3000K	90	60,000 hours





1" RECESSED IN-GROUND + INDICATOR

- Factory sealed watertight fixtures
- Solid stainless steel construction
- Options for use in outdoor downlight applications
- Constant output for 9V-15V input
- 100%-10% dimming - see specification sheet for list of tested dimmers

Fixture Finish Options:

BS	Bronze Stainless Steel
SS	Stainless Steel

Example: **1011-30SS**
Transformer Required
See Accessories page for more detail



1" Slim Round

1011-27	SS
1011-30	



1" Round

1021-27	SS
1021-30	



1" Square

1051-27	SS
1051-30	

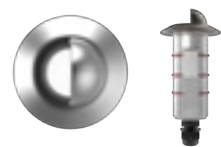
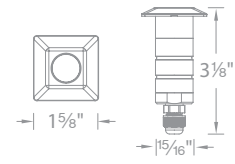
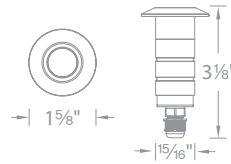
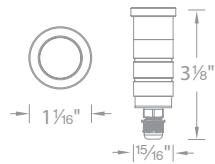

1" Scoop

1061-27	BS
1061-30	



1" Shroud

1031-27	BS
1031-30	

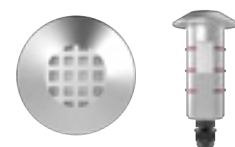

1" Louver

1041-27	BS
1041-30	

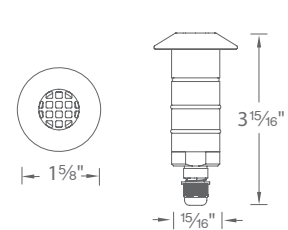
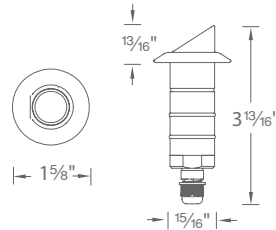
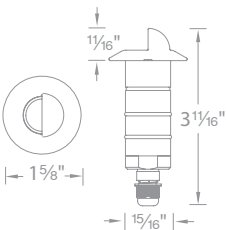

6' Lead Wire included

Optional spring clip accessory included

Optional spring clip accessory included

Input	Power	Brightness	Beam Angle	Color Temp	CRI	Rated Life
9-15VAC	1.9W / 3VA	Up to 80 lm	50° (When an open top is used)	2700K, 3000K	85	70,000 hours

Accessories

- 1" Concrete Pour Kit
- 1000-CON-PVC**



2" RECESSED IN-GROUND + INDICATOR

- Factory sealed watertight fixtures
- Solid stainless steel construction
- Constant output for 9V-15V input
- 100%-10% dimming - see specification sheet for list of tested dimmers
- Available concrete pour kit with 18" PVC pipe which can be field shortened
- Optional spring clip accessory included

Fixture Finish Options:

BS Bronze Stainless Steel
SS Stainless Steel

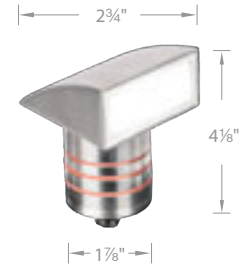

Example: **2081-30SS**
Transformer Required
See Accessories page for more detail



2" Ground Hood

Beam Angle:
Asymmetrical

2081-27	BS
2081-30	SS

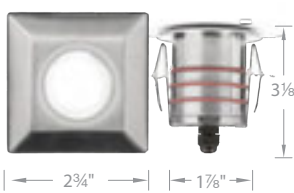
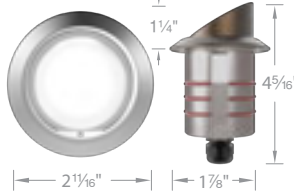
 <p>2" Slim Round</p> <table border="1"> <tr> <td>2011-27</td> <td>BS</td> <td>2012-27</td> <td>BS</td> </tr> <tr> <td>2011-30</td> <td>SS</td> <td>2012-30</td> <td>SS</td> </tr> </table>		2011-27	BS	2012-27	BS	2011-30	SS	2012-30	SS	 <p>2" Slim Round with Honeycomb Louver</p> <table border="1"> <tr> <td>2021-27</td> <td>BS</td> <td>2022-27</td> <td>BS</td> </tr> <tr> <td>2021-30</td> <td>SS</td> <td>2022-30</td> <td>SS</td> </tr> </table>		2021-27	BS	2022-27	BS	2021-30	SS	2022-30	SS	 <p>2" Round</p> <table border="1"> <tr> <td>2051-27</td> <td>BS</td> <td>2052-27</td> <td>BS</td> </tr> <tr> <td>2051-30</td> <td>SS</td> <td>2052-30</td> <td>SS</td> </tr> </table>		2051-27	BS	2052-27	BS	2051-30	SS	2052-30	SS	 <p>2" Round with Honeycomb Louver</p> <table border="1"> <tr> <td>2111-27</td> <td>BS</td> <td>2111-30</td> <td>BS</td> </tr> <tr> <td>2111-30</td> <td>SS</td> <td></td> <td>SS</td> </tr> </table>		2111-27	BS	2111-30	BS	2111-30	SS		SS
2011-27	BS	2012-27	BS																																				
2011-30	SS	2012-30	SS																																				
2021-27	BS	2022-27	BS																																				
2021-30	SS	2022-30	SS																																				
2051-27	BS	2052-27	BS																																				
2051-30	SS	2052-30	SS																																				
2111-27	BS	2111-30	BS																																				
2111-30	SS		SS																																				

 <p>2" Quad Directional</p> <table border="1"> <tr> <td>2101-27</td> <td>BS</td> </tr> <tr> <td>2101-30</td> <td>SS</td> </tr> </table>		2101-27	BS	2101-30	SS	 <p>2" Single Direction</p> <table border="1"> <tr> <td>2091-27</td> <td>BS</td> </tr> <tr> <td>2091-30</td> <td>SS</td> </tr> </table>		2091-27	BS	2091-30	SS	 <p>2" Bi-Directional</p> <table border="1"> <tr> <td>2071-27</td> <td>BS</td> </tr> <tr> <td>2071-30</td> <td>SS</td> </tr> </table>		2071-27	BS	2071-30	SS	 <p>2" Scoop</p> <table border="1"> <tr> <td>2131-27</td> <td>BS</td> </tr> <tr> <td>2131-30</td> <td>SS</td> </tr> </table>		2131-27	BS	2131-30	SS
2101-27	BS																						
2101-30	SS																						
2091-27	BS																						
2091-30	SS																						
2071-27	BS																						
2071-30	SS																						
2131-27	BS																						
2131-30	SS																						

Input	Power	Brightness	Beam Angle	Color Temp	CRI	Rated Life
9-15VAC	4.1W / 6.6VA	Up to 245 lm	30° (When an open top is used)	2700K, 3000K	85	70,000 hours

*Optional spring clip accessory included. 6' Lead Wire included.

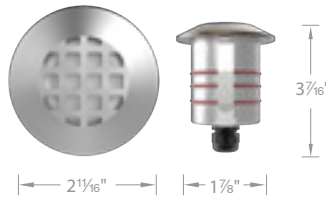

2" Louver

2121-27	BS
2121-30	SS

Accessories

2" Concrete Pour Kit
2000-CON-PVC





2" SUBMERSIBLE, IN-GROUND



Fully submersible and engineered for wet environments, this compact in-ground fixture delivers focused illumination for ponds, fountains, and water features. Constructed for durability and sealed against water intrusion, it provides reliable performance in fully submerged or wet-location applications.

- Constant output for 9V-15V input
- 100%-10% dimming - see specification sheet for list of tested dimmers
- May be used in conjunction with all landscape lighting products from WAC Lighting
- Includes a detachable stainless steel mounting bracket for use in or out of water
- Solid stainless steel construction
- Factory sealed water tight fixtures
- 30' long lead wire

Input	Power	Brightness	Beam Angle	Color Temp	CRI	Rated Life
9-15VAC	4.1W / 6.6VA	245 lm	25°	3000K	85	70,000 hours



Includes stainless steel easy mount accessory for use with underwater applications and above ground on any surface

Designed for underwater or wet application
30ft long lead wire

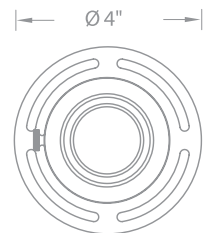
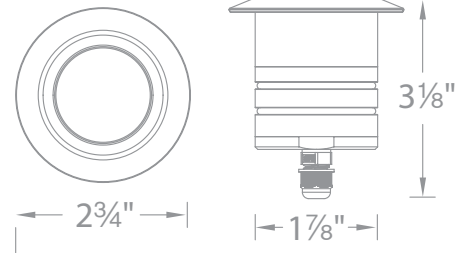

Ordering Chart

12V	Fixture Finish Options:
2031-30	SS Stainless Steel

Example: **2031-30SS**
Transformer Required

UNDERWATER SPOT



Built from solid cast brass, this underwater spotlight adds timeless durability and warm architectural presence to fountains, ponds, and shallow water features. Factory-sealed for long-term reliability, it provides bright, tunable illumination for tailored underwater effects.

- Machined brass thumb screws
- Cast brass construction
- Underwater in depths up to 3'
- Factory sealed watertight fixtures
- 30' long lead wire
- Limited lifetime warranty

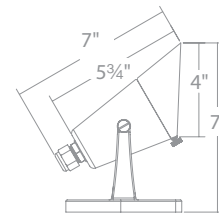
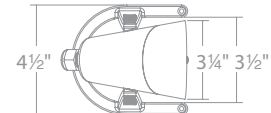

Input	Power	Brightness	Beam Angle	Color Temp	CRI	Rated Life
12-15VAC	10W/11.2VA	780 lm	60°	3000K	85	50,000 hours

Ordering Chart

12V

Fixture Finish Options:

5511-30

NB Natural Brass

Example: **5511-30NB**

Detachable shroud and direct-burial gel-filled wire nuts (12V)

Transformer Required

See Accessories page for more detail

Accessories Submersible luminaire

Optics

- LENS-20-AMB**
- LENS-20-GRN**
- LENS-20-RED**
- LENS-20-BLU**
- LENS-20-FR**
- LENS-20-SPR**

Direct Burial Waterproof Wire Nuts

9020-WNT-BK







IP66

UL US
1838 listed

TREE LIGHTS



Continuously Adjustable Beam Angles
Indexed at 35°, 45°, 55°



Select Warm White, Pure White, or Cool
White (2700K, 3000K or 4000K)



Continuously Adjustable Brightness

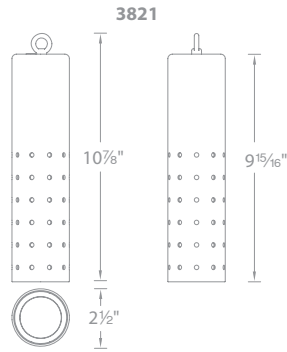

Matching Ceiling Mount

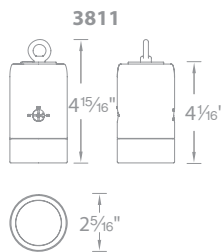
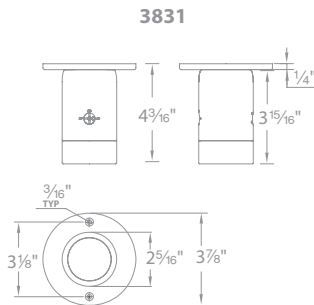

Input	Power	Brightness	CCT	CRI	Rated Life
9-15VAC	1W - 7.5W 2VA - 8VA	45lm - 380lm	2700K, 3000K 4000K	85	50,000 hours

Ordering Chart

Accessories

Optics

- LENS-11-AMB
- LENS-11-GRN
- LENS-11-RED
- LENS-11-BLU
- LENS-11-FR

12V	Pendant
3811-27/30/40	BK BZ

12V	Pendant
3821-27/30/40	BK BZ

12V	Ceiling Mount
3831-27/30/40	BK BZ WT*

Fixture Finish Options:

BK	Black on Aluminum
BZ	Bronze on Aluminum
WT*	White on Aluminum

Example: **3831-27/30/40WT**

3811/3821: 6' Chain included

Transformer Required

*WT finish available for 3831 model only

WALL CYLINDER 12V UP AND DOWN LIGHT

PATENTED



A clean cylindrical form delivers balanced up and down illumination to enhance exterior walls with depth and definition. Featuring adjustable beam angles and on-fixture CCT selection for warm, pure, or cool white, this fixture provides precise, architectural lighting with dependable outdoor performance.

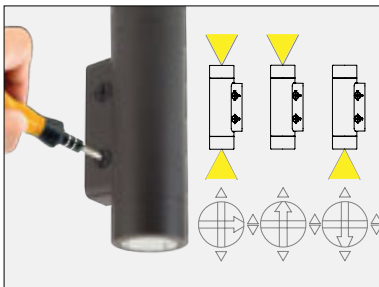
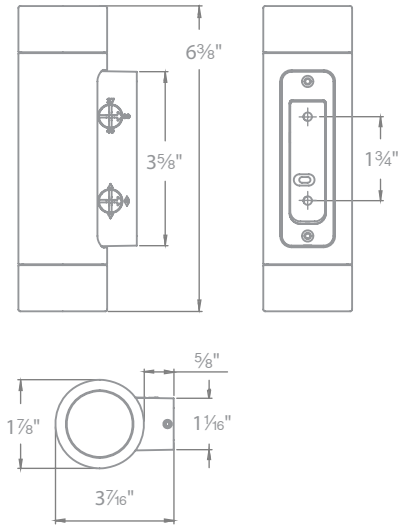

Select Up Light, Down Light or Both



Continuously Adjustable Beam Angles Indexed at 35°, 45°, 55°



Select Warm White, Pure White, or Cool White (2700K, 3000K or 4000K)

Input	Power	Brightness	Color Temp	CRI	Rated Life
9-15V	7.5W / 9.0VA 13.5W / 15VA (Both Lights On)	325 lm per light	2700K, 3000K, 4000K	85	50,000 hours

Ordering Chart

12V

Fixture Finish Options:

3611-27/30/40

BK Black on Aluminum
BZ Bronze on Aluminum
WT White on Aluminum

Example: **3611-27/30/40BZ**

Transformer Required

See Accessories page for more detail

Accessories

Optics

LENS-11-AMB **LENS-11-RED** **LENS-11-FR**
LENS-11-GRN **LENS-11-BLU**



HARDSCAPE

PATENTED   



7182-27/30 18 inches



7122-27/30 12 inches



7062-27/30 6 inches



7032 3 inches

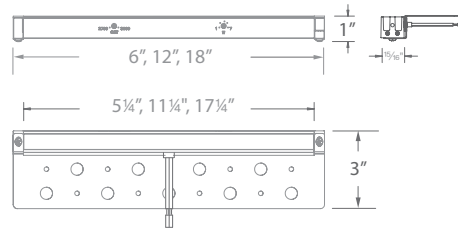

7062, 7122, 7182

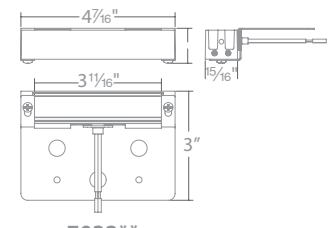

7032**

Designed for durability and ease of installation, hardscape features quick-release connections, field-selectable color temperature, corrosion-resistant aluminum construction, and a factory-sealed watertight design.

Ordering Chart

18"	12"	6"	3"	Fixture Finish Options:
7182-27/30	7122-27/30	7062-27/30	7032-27 7032-30	BK Black on Aluminum BZ Bronze on Aluminum BBR* Bronze on Brass GH Graphite on Aluminum SD Sand on Aluminum

Example: **7182-27/30BZ**

See photometric data on page 167

*BBR finish available for 7062 and 7122 model only



Select WarmWhite (2700K) or Pure White (3000K) light



PATENTED QUICK RELEASE

Based on popular demand, our new patented invention allows for a watertight male/female connection at the fixture for ease of replacement after it is installed



Continuously adjustable brightness



Removable stainless steel capstone bracket and rotating mounting clips included

- Tightly spaced and diffused LEDs for even illumination
- 6' lead wire and direct burial gel filled wire nuts included
- Easily serviceable, switch warm to pure white, and onboard dimming
- Corrosion-resistant aluminum alloy
- Factory-sealed, watertight fixture

	Input	Power	Brightness	Beam Angle	CRI	Color Temp	Rated Life
18"	9 - 15VAC	8.5W, 9.3VA	350lm	110°	85	2700K, 3000K	70,000 hours
12"	9 - 15VAC	7.0W, 7.6VA	230lm	110°	85	2700K, 3000K	70,000 hours
6"	9 - 15VAC	4.5W, 5.6VA	110lm	110°	85	2700K, 3000K	70,000 hours
3"	9 - 15VAC	1.5W, 2.6VA**	50lm	110°	85	2700K, 3000K**	70,000 hours

**Due to its compact size, the 7032 is dedicated in either 2700K or 3000K

**No integral brightness control for 7032 model
Transformer Required



LINEAR PATH LIGHT



 IP67 1838 listed



- Integral brightness control
- Low profile and discreet
- 180° fully rotatable fixture aiming
- Lock desired position in place after adjustment
- Wide Flood Beam 110° x 80°
- Adjustable anti-glare shroud
- Designed for soft ground, wood floor and concrete
- Base mount, riser mount & extension mount
- Path & Accent applications

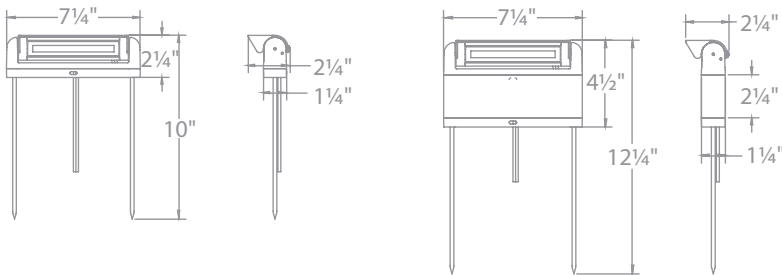

On-Board Dimming Knob

Input	Power	Brightness	Beam Angle	Color Temp	CRI	Rated Life
9-15VAC	1W - 6W 1.3VA - 8.6VA	65lm-190lm	110° x 80°	2700K, 3000K	85	60,000 hours



Optional riser attachment included

Ordering Chart

12V

Fixture Finish Options:

6401-27
6401-30

BK Black on Aluminum
BZ Bronze on Aluminum
BBR Bronze on Brass

Example: **6401-27BK**

See Accessories page for more detail
Detachable shroud, 10' lead wire and
direct-burial gel-filled wire nuts included
Transformer Required (order separately)

Accessories

9" Mounting Stake

Extension Rods

9000-ST9-BZ

5000-X04-BZ,BK,BBR
5000-X08-BZ,BK,BBR
5000-X12-BZ,BK,BBR
5000-X18-BZ,BK,BBR
5000-X24-BZ,BK,BBR



Extension mount included
(Order extension rods separately)



BROUGH

NEW FOR 2026



1838 listed

This modern path light features a slender form factor and a directional head that adjusts $\pm 90^\circ$ for precise lighting along walkways and landscapes. With selectable CCT and rugged aluminum construction, it delivers flexible performance for both residential and hospitality paths.

- Corrosion resistant aluminum alloy
- Adjustable directional light head $\pm 90^\circ$
- Factory-sealed, watertight fixture
- 5 CCT Selectable - 2700K/3000K/3500K/4000K/5000K

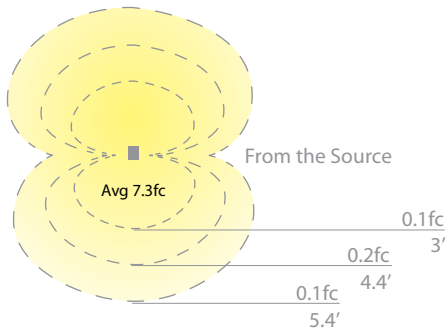
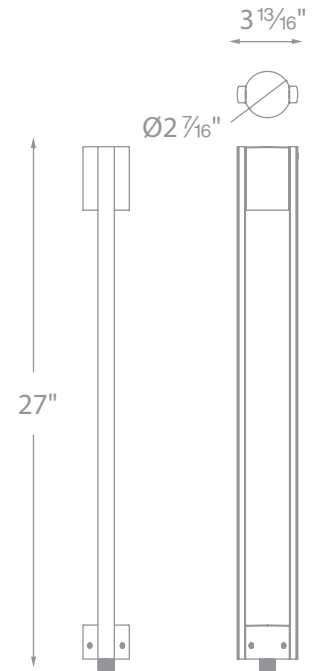

Input	Power	Brightness	Color Temp	CRI	Rated Life
9-15VAC	6.8W / 10.5VA	Up to 305lm	2700K, 3000K, 3500K 4000K, 5000K	90	50,000 hours

Ordering Chart

12V	Fixture Finish Options:
6121-5CS	BK Black on Aluminum BZ Bronze on Aluminum
Example: 6121-5CSBK 14" Mounting stake, 6 foot lead wire, and direct-burial gel-filled wire nuts included Transformer Required	

Accessories

14" Mounting Stake	Surface Mount Flange/Stake	Guardian Mount
9000-ST14-BZ	5000-SCP-BK 5000-SCP-BZ	9000-SP9-BZ







NEW FOR 2026

STANDUP

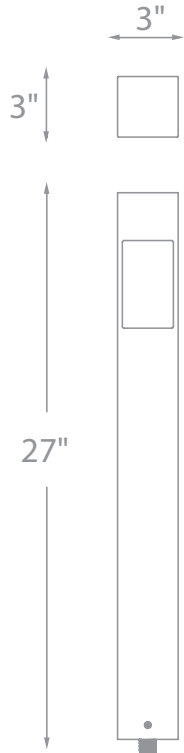

The Standup Path Light offers a clean, architectural silhouette with soft indirect illumination that minimizes glare along pathways and planted areas. Its selectable CCT and watertight construction provide long-lasting versatility for any landscape design.

- Corrosion resistant aluminum alloy
- Factory-sealed, watertight fixture
- Soft indirect illumination
- 5 CCT Selectable - 2700K/3000K/3500K/4000K/5000K

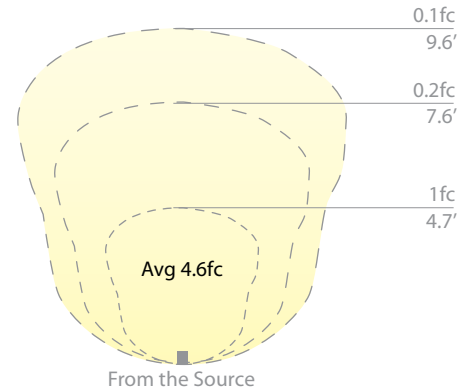

Input	Power	Brightness	Color Temp	CRI	Rated Life
9 - 15VAC	6.8W - 10.5VA	Up to 110lm	2700K, 3000K, 3500K 4000K, 5000K	90	50,000 hours

Accessories		
14" Mounting Stake	Surface Mount Flange/Stake	Guardian Mount
9000-ST14-BZ	5000-SCP-BK 5000-SCP-BZ	9000-SP9-BZ

Ordering Chart

12V	Fixture Finish Options:	
6131-5CS	BK	Black on Aluminum
	BZ	Bronze on Aluminum

Example: **6131-5CSBK**
14" Mounting stake, 6 foot lead wire, and direct-burial gel-filled wire nuts included
Transformer Required

The Hilyne Path Light pairs a tall, minimalist profile with a slim vertical aperture that emits soft, glare-controlled illumination. Built for durability with selectable CCT, it elegantly defines walkways and gardens with refined simplicity.

- Corrosion resistant aluminum alloy
- Factory-sealed, watertight fixture
- Soft indirect illumination
- 5 CCT Selectable - 2700K/3000K/3500K/4000K/5000K

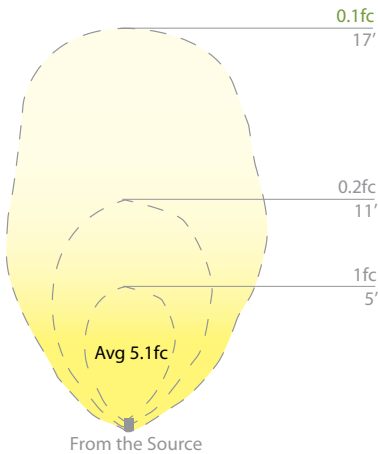
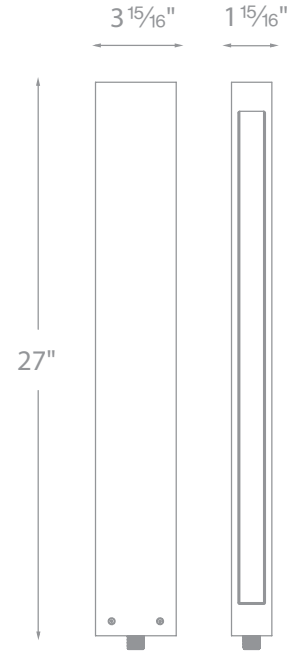

Input	Power	Brightness	Color Temp	CRI	Rated Life
9 - 15VAC	6.8W / 10.5VA	200lm	2700K, 3000K, 3500K 4000K, 5000K	90	50,000 hours

Ordering Chart

12V	Fixture Finish Options:
6141-5CS	BK Black on Aluminum BZ Bronze on Aluminum

Example: **6141-5CSBZ**
14" Mounting stake, 6 foot lead wire, and direct-burial gel-filled wire nuts included
Transformer Required

Accessories

14" Mounting Stake	Surface Mount Flange/Stake	Guardian Mount
9000-ST14-BZ	5000-SCP-BK 5000-SCP-BZ	9000-SP9-BZ



TIKI



A slender form with a directional head delivers controlled illumination for pathways and landscapes. Designed for durability, this area light features a sturdy center mount, recommended spacing for residential and commercial applications, solid brass or aluminum construction, and a factory-sealed watertight design.

- Sturdy center mount design works well in applications where area illumination is desired
- Recommended spacing for installation:
Residential: 7 to 9ft
Commercial: 5 to 7ft
- Factory-sealed, watertight fixture
- Solid brass or corrosion resistant aluminum alloy
- Constant output for 9V-15V input

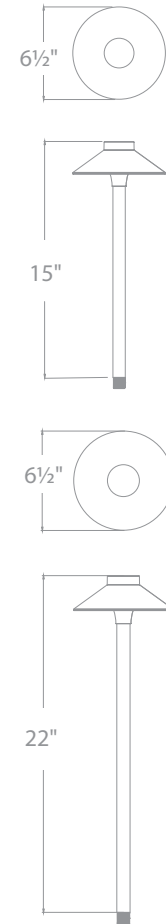

Input	Power	Brightness	Color Temp	CRI	Rated Life
9-15VAC	6.5W / 9.5VA	Up to 225lm	2700K, 3000K	90	60,000 hours

Ordering Chart

15"	22"
6042-27 6042-30	6041-27 6041-30

Fixture Finish Options:

BK	Black on Aluminum
BZ	Bronze on Aluminum
BBR*	Bronze on Brass

Example: **6042-27BZ**

*BBR finish available for 6041 model only
Transformer Required

9" Mounting stake, 6 foot lead wire, and direct-burial gel-filled wire nuts included
See Accessories page for more detail

Accessories

9" Mounting Stake	14" Mounting Stake	Surface Mount Flange/Stake	Guardian Mount
9000-ST9-BZ	9000-ST14-BZ	5000-SCP-BK 5000-SCP-BZ 5000-SCP-BBR	9000-SP9-BZ

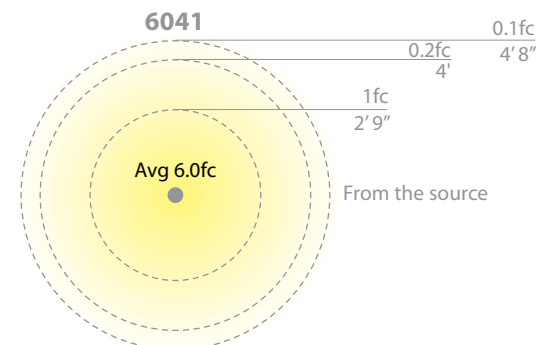
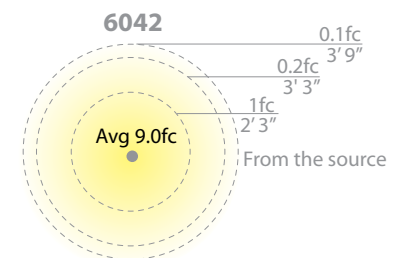



CANOPY

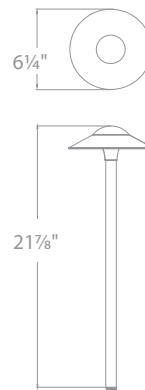
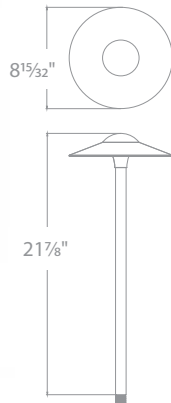
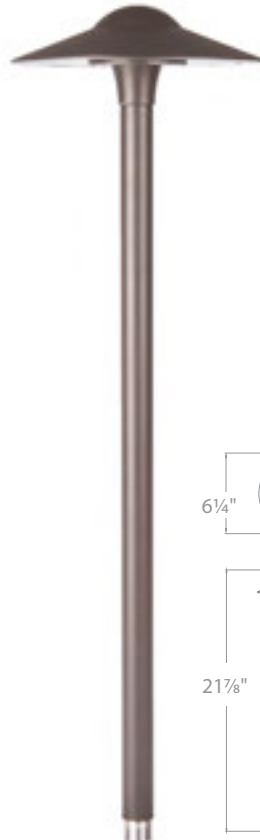

Designed for area illumination, this canopy-style path light features a sturdy center mount and durable construction for long-term outdoor use. With recommended spacing for residential and commercial settings, it offers consistent output from a factory-sealed, corrosion-resistant fixture.

- Sturdy center mount design works well in applications where area illumination is desired
- Recommended spacing for installation:
Residential: 7 to 9ft
Commercial: 5 to 7ft
- Factory-sealed, watertight fixture
- Solid brass or corrosion resistant aluminum alloy
- Constant output for 9V-15V input

Input	Power	Brightness	Color Temp	CRI	Rated Life
9-15VAC	6.5W / 9.5VA	Up to 225lm	2700K, 3000K	90	60,000 hours

Ordering Chart

8" Cap	6" Cap	Fixture Finish Options:	
6051-27 6051-30	6053-27 6053-30	BK	Black on Aluminum
		BZ	Bronze on Aluminum
		BBR	Bronze on Brass

Example: **6051-27BBR**

Mounting stake, 6 foot lead wire, and direct-burial gel-filled wire nuts included
Transformer Required

See Accessories page for more detail

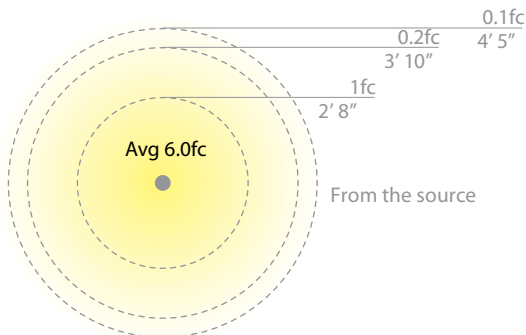

Accessories

9" Mounting Stake	14" Mounting Stake	Surface Mount Flange/Stake	Guardian Mount
9000-ST9-BZ	9000-ST14-BZ	5000-SCP-BK 5000-SCP-BZ 5000-SCP-BBR	9000-SP9-BZ





6511

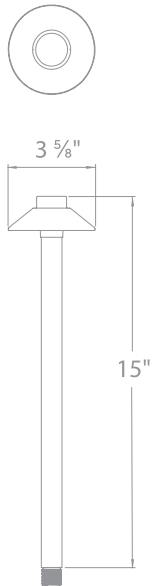

6521

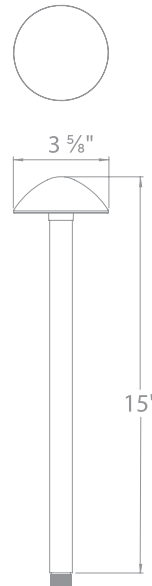

A slender silhouette casts a gentle pool of light along pathways and garden edges, bringing warmth and quiet definition to the landscape. Designed with a sturdy center mount and durable construction, this area light delivers consistent illumination for residential and hospitality settings.

- Simple design with small form factor, natural fit to any landscape
- Sturdy center mount design works well in applications where area illumination is desired
- Recommended spacing for installation:
Residential: 4 to 6ft
Commercial: 3 to 4ft

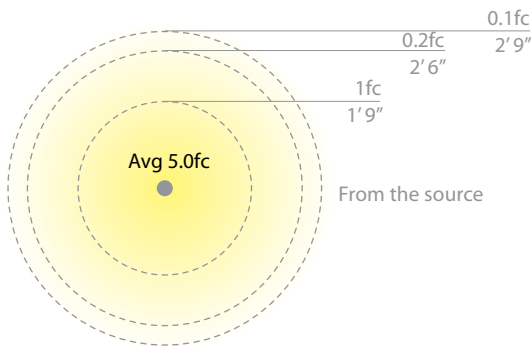

Input	Power	Brightness	Color Temp	CRI	Rated Life
9 - 15VAC	2.5W - 2.7VA	Up to 100lm	2700K, 3000K	90	60,000 hours

Accessories

9" Mounting Stake	14" Mounting Stake	Surface Mount Flange/Stake	Guardian Mount
9000-ST9-BZ	9000-ST14-BZ	5000-SCP-BK 5000-SCP-BZ 5000-SCP-BBR	9000-SP9-BZ

Ordering Chart

12V		Fixture Finish Options:	
6511-27	6521-27	BK	Black on Aluminum
6511-30	6521-30	BZ	Bronze on Aluminum
		BBR*	Bronze on Brass

Example: **6511-27BBR**
 *BBR finish available for 6511 model only
 Mounting stake, 6 foot lead wire, and direct-burial gel-filled wire nuts included
 Transformer Required
 See Accessories page for more detail

AREA



A broad, sculptural form casts a welcoming glow across pathways and open landscapes, creating a calm and comfortable sense of place. Designed for durability and outdoor performance, this area light delivers consistent illumination from a factory-sealed, corrosion-resistant fixture.

- Broad appeal makes this fixture suitable for varying landscape designs
- Recommended spacing for installation :
Residential: 11 to 13ft
Commercial: 7 to 9ft
- IP66 Rated, protected against high-pressure water jets
- Factory-sealed, watertight fixture
- Solid brass or corrosion resistant aluminum alloy
- Constant output for 9V-15V input

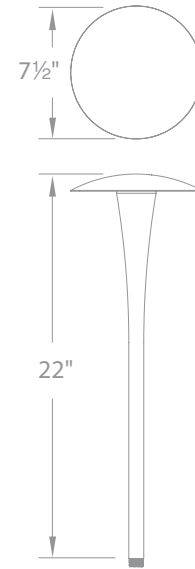

Input	Power	Brightness	Color Temp	CRI	Rated Life
9-15VAC	5.8W / 9.4VA	Up to 150lm	2700K, 3000K	90	60,000 hours

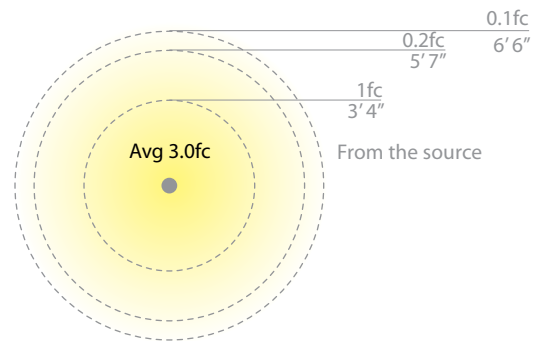

Ordering Chart

12V

Fixture Finish Options:

6011-27
6011-30

BK Black on Aluminum
BZ Bronze on Aluminum
BBR Bronze on Brass

Example: **6011-27BZ**
Mounting stake, 6 foot lead wire, and direct-burial gel-filled wire nuts included
Transformer Required
See Accessories page for more detail

Accessories

9" Mounting Stake	14" Mounting Stake	Surface Mount Flange/Stake	Guardian Mount
9000-ST9-BZ	9000-ST14-BZ	5000-SCP-BK 5000-SCP-BZ 5000-SCP-BBR	9000-SP9-BZ



SLOPE

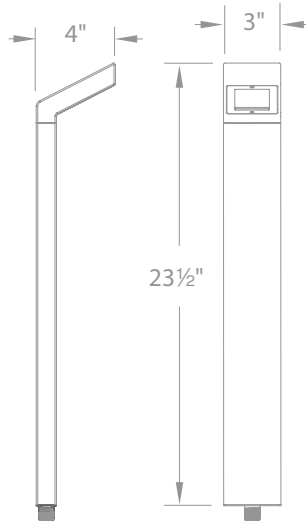

A slim, angular profile guides light gently along pathways, blending seamlessly into the landscape. Designed for visual comfort and durability, this path light provides even illumination from a factory-sealed fixture built for long-term outdoor use.

- Sleek linear design blends seamlessly into pathways while providing soft, even illumination
- Recommended spacing for installation:
Residential: 7 to 9ft
Commercial: 4 to 6ft
- Factory-sealed, watertight fixture
- Constant output for 9V-15V input

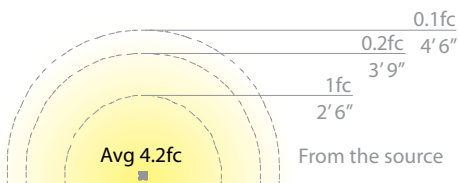

Input	Power	Brightness	Color Temp	CRI	Rated Life
9-15VAC	2.9W / 4.7VA	Up to 95lm	2700K, 3000K	90	60,000 hours

Accessories

9" Mounting Stake	14" Mounting Stake	Surface Mount Flange/Stake	Guardian Mount
9000-ST9-BZ	9000-ST14-BZ	5000-SCP-BK 5000-SCP-BZ	9000-SP9-BZ

Ordering Chart

12V	Fixture Finish Options:
6021-27 6021-30	BK Black on Aluminum BZ Bronze on Aluminum

Example: **6021-27BZ**
14" Mounting stake, 6 foot lead wire, and direct-burial gel-filled wire nuts included
Transformer Required
See Accessories page for more detail

SLIDE



A sleek, linear form integrates smoothly into pathways, providing soft, even illumination for clear wayfinding. Factory sealed for outdoor durability, this path light delivers consistent output from a compact design suited to residential and commercial landscape applications.

- Sculpted form integrates naturally into pathways while delivering soft, even illumination
- Factory-sealed, watertight fixture
- Constant output for 9V-15V input

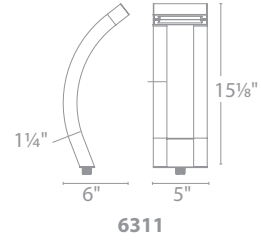

6311

6321

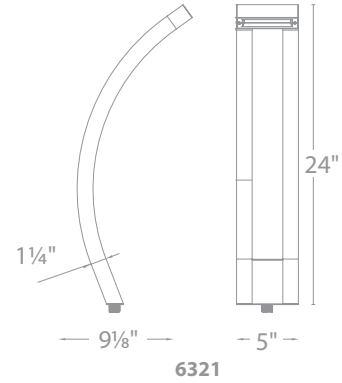

Input	Power	Brightness	Color Temp	CRI	Rated Life
9-15VAC	3.0W / 4.5VA	Up to 95lm	3000K Pure white	90	60,000 hours

Recommended spacing for installation:

6311 Small

- Residential: 7 to 9ft
- Commercial: 4 to 6ft

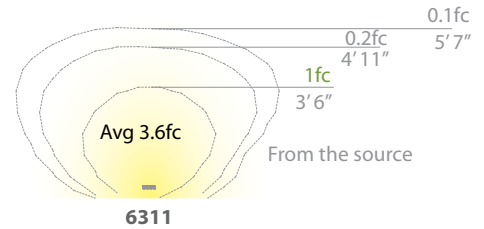

6311

Ordering Chart

Small	Large	Fixture Finish Options:
6311-30	6321-30	BZ Bronze on Aluminum

Example: **6311-30BZ**
 14" Mounting stake, 6 foot lead wire, and direct-burial gel-filled wire nuts included
 Transformer Required
 See Accessories page for more detail

Recommended spacing for installation:

6321 Large

- Residential: 9 to 11ft
- Commercial: 5 to 7ft

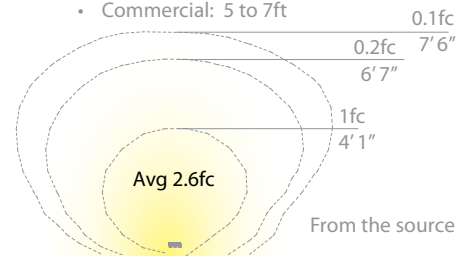

6321

Accessories

9" Mounting Stake	14" Mounting Stake	Surface Mount Flange/Stake	Guardian Mount
9000-ST9-BZ	9000-ST14-BZ	5000-SCP-BZ	9000-SP9-BZ



BALANCE



A slim, linear profile delivers focused pathway illumination with a clean, architectural presence. Designed to blend seamlessly into the landscape, this fixture provides soft, even light from a factory-sealed construction built for consistent outdoor performance.

- Sleek linear design blends seamlessly into pathways while providing soft, even illumination
- Recommended spacing for installation:
Residential: 11 to 13ft
Commercial: 7 to 9ft
- Factory-sealed, watertight fixture
- Constant output for 9V-15V input

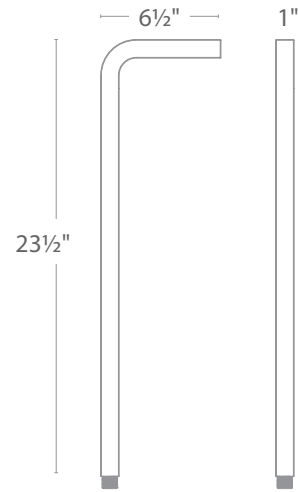

Input	Power	Brightness	Color Temp	CRI	Rated Life
9-15VAC	6.5W / 11.5VA	Up to 275lm	2700K, 3000K	90	60,000 hours

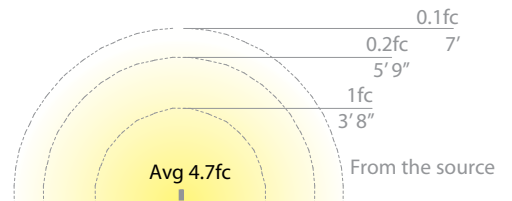

Ordering Chart

12V	Fixture Finish Options:	
6061-27	BK	Black on Aluminum
6061-30	BZ	Bronze on Aluminum
	BBR	Bronze on Brass

Example: **6061-27BZ**
9" Mounting stake, 6 foot lead wire, and direct-burial gel-filled wire nuts included
Transformer Required
See Accessories page for more detail

Accessories

9" Mounting Stake	14" Mounting Stake	Surface Mount Flange/Stake	Guardian Mount
9000-ST9-BZ	9000-ST14-BZ	5000-SCP-BK 5000-SCP-BZ 5000-SCP-BBR	9000-SP9-BZ



BALANCE

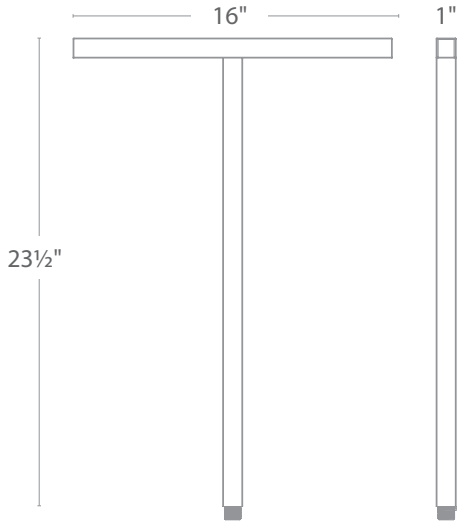
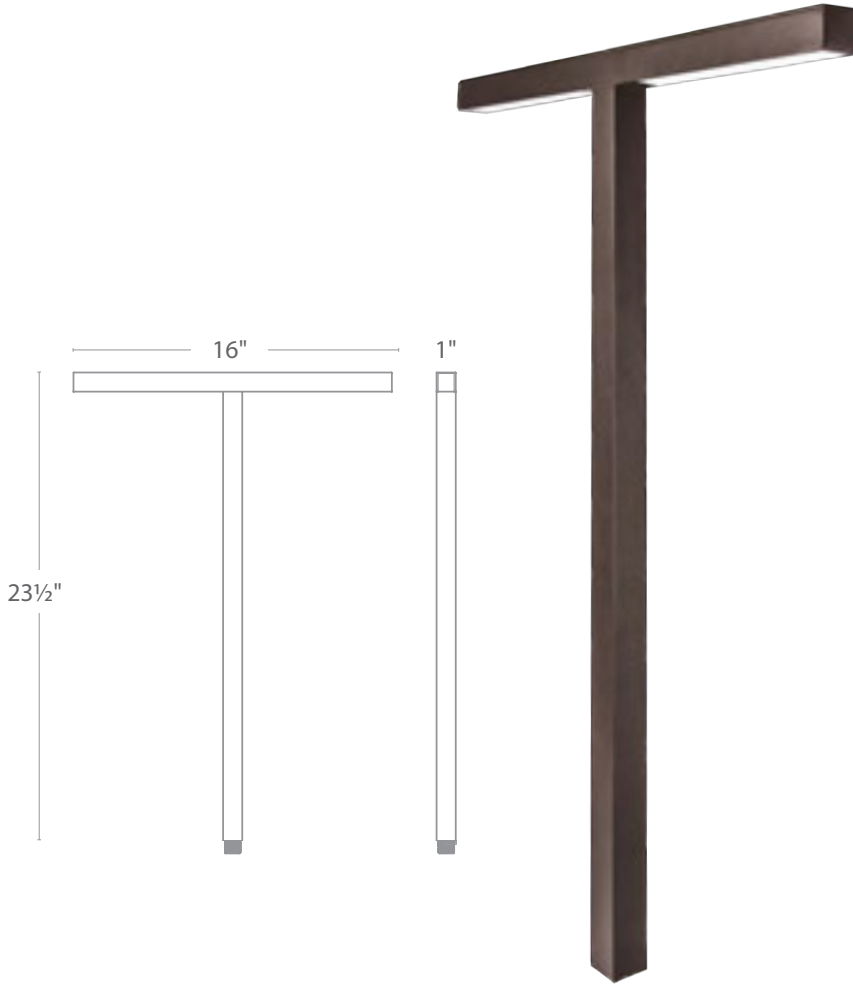

A balanced, horizontal form casts even illumination across wider pathways and shared spaces. With a sleek linear design and durable, factory-sealed construction, this fixture delivers consistent, low-glare lighting suited to residential and commercial environments.

- Sleek linear design blends seamlessly into pathways while providing soft, even illumination
- Recommended spacing for installation:
Residential: 11 to 13ft
Commercial: 7 to 9ft
- Factory-sealed, watertight fixture
- Constant output for 9V-15V input

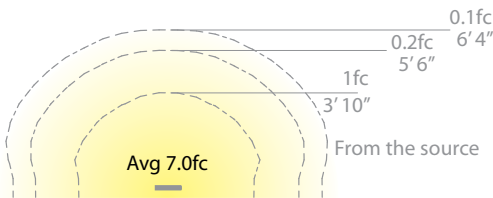

Input	Power	Brightness	Color Temp	CRI	Rated Life
9-15VAC	10W / 14VA	Up to 375lm	2700K, 3000K	90	60,000 hours

Accessories

9" Mounting Stake	14" Mounting Stake	Surface Mount Flange/Stake	Guardian Mount
9000-ST9-BZ	9000-ST14-BZ	5000-SCP-BK 5000-SCP-BZ	9000-SP9-BZ

Ordering Chart

12V	Fixture Finish Options:
6071-27 6071-30	BK Black on Aluminum BZ Bronze on Aluminum

Example: **6071-27BZ**
9" Mounting stake, 6 foot lead wire, and direct-burial gel-filled wire nuts included
Transformer Required
See Accessories page for more detail





QUAD



A bold, angular form delivers soft, downward illumination to guide pathways with clarity and control. Designed to blend seamlessly into the landscape, this path light features durable, factory-sealed construction and provides consistent output for residential and commercial outdoor environments.

- Sleek linear design blends seamlessly into pathways while providing soft, even illumination
- Recommended spacing for installation:
Residential: 8 to 10ft
Commercial: 5 to 7ft
- Factory-sealed, watertight fixture
- Constant output for 9V-15V input

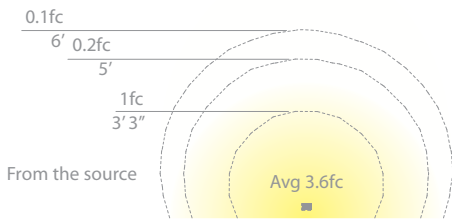

Input	Power	Brightness	Color Temp	CRI	Rated Life
9-15VAC	3W / 4.5VA	Up to 100lm	2700K, 3000K	90	60,000 hours

Accessories

9" Mounting Stake	14" Mounting Stake	Surface Mount Flange/Stake	Guardian Mount
9000-ST9-BZ	9000-ST14-BZ	5000-SCP-BZ	9000-SP9-BZ

Ordering Chart

12V	Fixture Finish Options:
6091-27 6091-30	BZ Bronze on Aluminum

Example: **6091-27BZ**
14" Mounting stake, 6 foot lead wire, and direct-burial gel-filled wire nuts included
Transformer Required
See Accessories page for more detail

ECLIPSE



A rounded, directional head delivers controlled illumination along pathways and landscape edges. Designed for durability and visual comfort, this path light features a sturdy side mount, factory-sealed construction, and consistent output for residential and commercial outdoor environments.

- Sturdy side mount design works well in applications where directional illumination is desired
- Recommended spacing for installation:
Residential: 8 to 10ft
Commercial: 5 to 7ft
- Factory-sealed, watertight fixture
- Solid die-cast corrosion resistant aluminum alloy
- Constant output for 9V-15V input

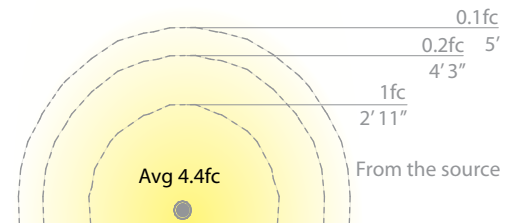
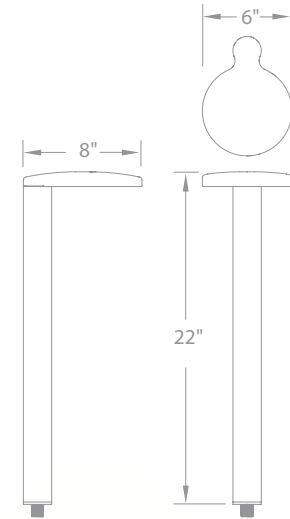

Input	Power	Brightness	Color Temp	CRI	Rated Life
9-15VAC	2.9W / 4.7VA	Up to 125lm	2700K, 3000K	90	60,000 hours

Ordering Chart

12V	Fixture Finish Options:	
6031-27	BK	Black on Aluminum
6031-30	BZ	Bronze on Aluminum
Example: 6031-27BZ		
14" Mounting stake, 6 foot lead wire, and direct-burial gel-filled wire nuts included		
Transformer Required		
See Accessories page for more detail		

Accessories

9" Mounting Stake	14" Mounting Stake	Surface Mount Flange/Stake	Guardian Mount
9000-ST9-BZ	9000-ST14-BZ	5000-SCP-BK 5000-SCP-BZ	9000-SP9-BZ



LEDGE



A slim, rectilinear form casts soft, even illumination while blending seamlessly into modern landscapes. With durable, factory-sealed construction and a compact footprint, this path light provides reliable guidance lighting for residential and commercial applications.

- Sleek linear design blends seamlessly into pathways while providing soft, even illumination
- Recommended spacing for installation:
Residential: 8 to 10ft
Commercial: 5 to 7ft
- Factory-sealed, watertight fixture
- Constant output for 9V-15V input

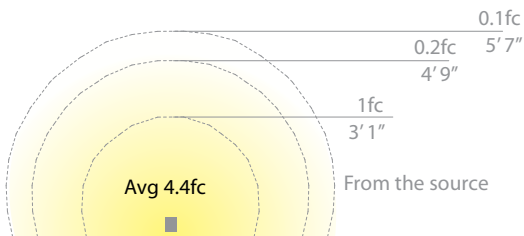

Input	Power	Brightness	Color Temp	CRI	Rated Life
9-15VAC	3.0W / 4.5VA	Up to 105lm	2700K, 3000K	90	60,000 hours

Accessories

9" Mounting Stake	14" Mounting Stake	Surface Mount Flange/Stake	Guardian Mount
9000-ST9-BZ	9000-ST14-BZ	5000-SCP-BK 5000-SCP-BZ	9000-SP9-BZ

Ordering Chart

12V	Fixture Finish Options:
6081-27 6081-30	BK Black on Aluminum BZ Bronze on Aluminum

Example: **6081-27BZ**
14" Mounting stake, 6 foot lead wire, and direct-burial gel-filled wire nuts included
Transformer Required
See Accessories page for more detail





NEW FOR 2026

GRAND LEDGE 12V/120V-277V

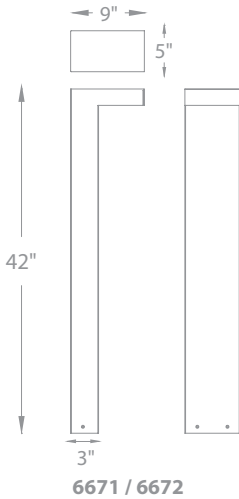

6671 / 6672

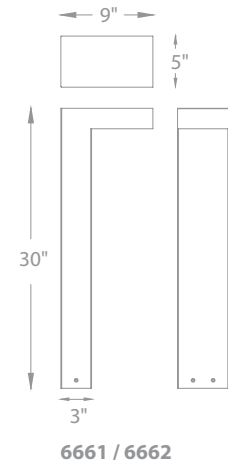

6661 / 6662



6661 / 6662

6671 / 6672

This linear bollard delivers high-output, Type II pathway illumination for large residential and commercial environments. With selectable CCT and dual-voltage flexibility, it offers powerful performance and clean visual lines for plazas, pathways, and campuses.

- Sleek linear design blends seamlessly into pathways while providing soft, even illumination
- Factory-sealed, watertight fixture
- Corrosion resistant aluminum alloy
- Type II lighting distribution
- 5 CCT Selectable - 2700K/3000K/3500K/4000K/5000K

12V

120V

Input	Power	Brightness	Color Temp	CRI	Rated Life
12V					
9-15VAC	24W / 24VA	Up to 1780lm	2700K, 3000K, 3500K 4000K, 5000K	90	50,000 hours
Transformer Required (order separately)					
120V - 277V					
120-277VAC	23W	Up to 1780lm	2700K, 3000K, 3500K 4000K, 5000K	90	50,000 hours

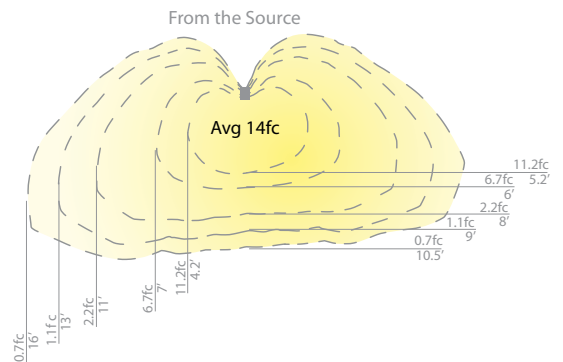

Mounting accessory included

12V

120V/277V



M6000-STAKE



M6630-CON-KIT

Ordering Chart

	12V	120V-277V	Fixture Finish Options:	
30"	6661-5CS	6662-5CS	BK	Black on Aluminum
42"	6671-5CS	6672-5CS	BZ	Bronze on Aluminum

Example: **6661-5CSBZ**

DECIBEL

NEW FOR 2026



1838 listed

A compact, sculptural bollard with a smooth curved form, the Decibel provides warm, indirect illumination that complements any landscape style. Its one-piece die-cast body and sealed design ensure durability in demanding outdoor settings.

- Simple design with small form factor, natural fit to any landscape
- One-piece die-cast aluminum body

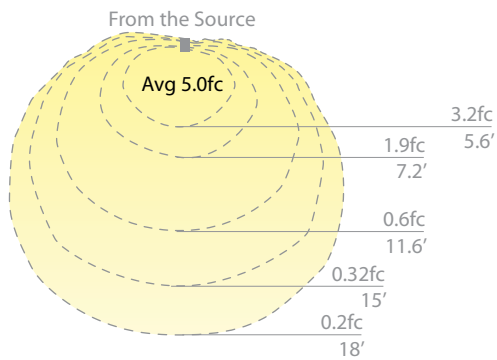
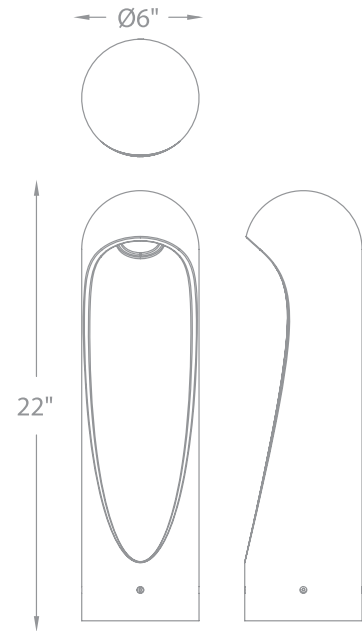

Input	Power	Brightness	Color Temp	CRI	Rated Life
9 - 15VAC	8.5W / 10VA	Up to 365lm	2700K, 3000K	90	50,000 hours

Ordering Chart

12V

Fixture Finish Options:

6701-27
6701-30

BK Black on Aluminum
BZ Bronze on Aluminum
GT Granite on Aluminum

Example: **6701-27GT**
6 foot lead wire, and direct-burial gel-filled wire nuts included
Transformer Required

Mounting accessory included

12V



M6000-STAKE



NEW FOR 2026

PASSAGE

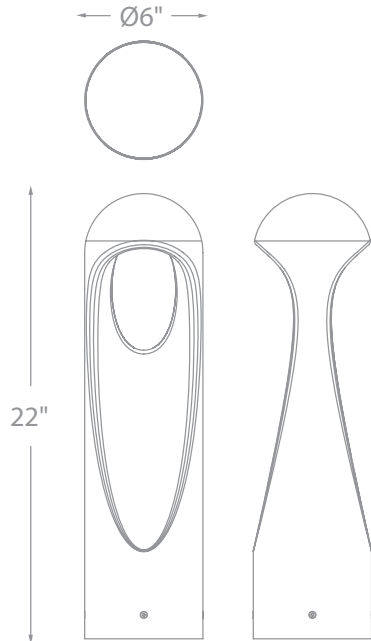

The Passage Bollard features a soft, enveloping downward glow created by its recessed aperture, ideal for walkways and gathering spaces. Its simple geometric form and robust construction make it both visually subtle and highly reliable.

- One-piece die-cast aluminum body
- Factory-sealed, watertight fixture
- Soft indirect illumination

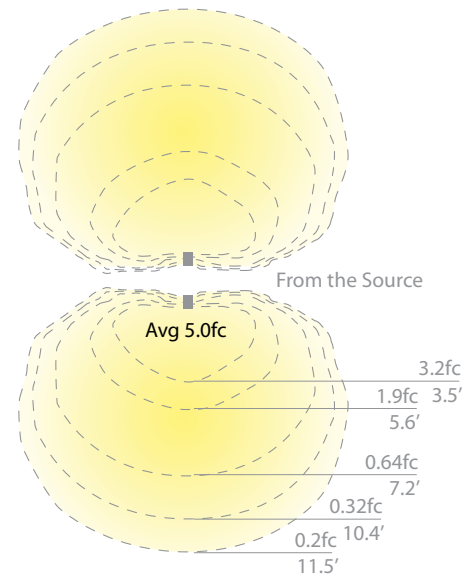

Input	Power	Brightness	Color Temp	CRI	Rated Life
9 - 15VAC	8.5W / 10VA	345lm	2700K, 3000K	90	50,000 hours

Mounting accessory included

12V



M6000-STAKE

Ordering Chart

12V

6702-27
6702-30

Fixture Finish Options:

BK Black on Aluminum
BZ Bronze on Aluminum
GT Granite on Aluminum

Example: **6702-30BZ**
6 foot lead wire, and
direct-burial gel-filled wire nuts included
Transformer Required

EVEN

NEW FOR 2026



1838 listed

With a sleek linear design and even light distribution, the Even Bollard creates clean, consistent illumination along paths and open landscapes. Its watertight construction and constant-output driver deliver dependable performance across voltage variations.

- Sleek linear design blends seamlessly into pathways while providing soft, even illumination
- Factory-sealed, watertight fixture
- Constant output for 9V-15V input

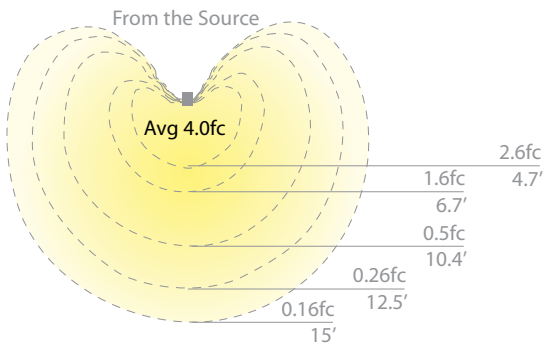
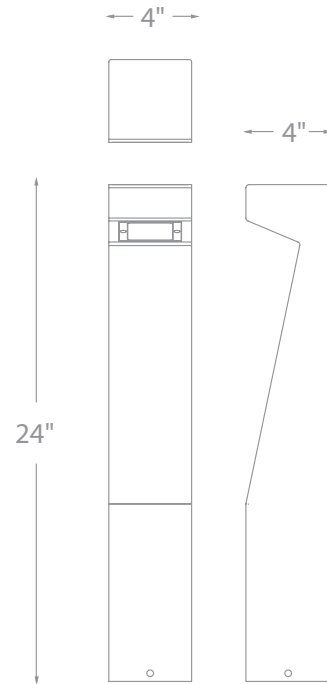

Input	Power	Brightness	Color Temp	CRI	Rated Life
9-15VAC	8.5W /10VA	Up to 510lm	2700K, 3000K	90	50,000 hours

Ordering Chart

12V	Fixture Finish Options:
6703-27	BK Black on Aluminum
6703-30	BZ Bronze on Aluminum
	GT Granite on Aluminum

Example: **6703-27GT**
6 foot lead wire, and direct-burial-gel filled wire nuts included
Transformer Required

Mounting accessory included



M6000-STAKE







NEW FOR 2026

ALTAR

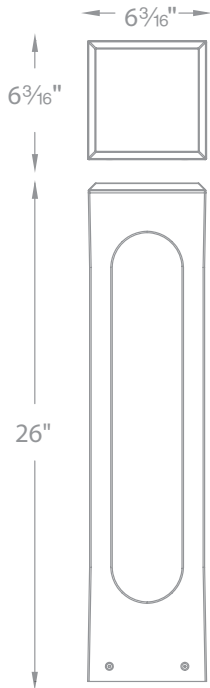

The Altar Bollard's center-lit design casts a symmetrical, multidirectional glow that enhances both pathways and open landscape zones. Its compact form and sealed construction make it a practical solution where steady area illumination is needed.

- Simple design with small form factor, natural fit to any landscape
- Sturdy center mount design works well in applications where area illumination is desired

Input	Power	Brightness	Color Temp	CRI	Rated Life
9 - 15VAC	8.5W / 10VA	Up to 385lm	2700K, 3000K	90	50,000 hours

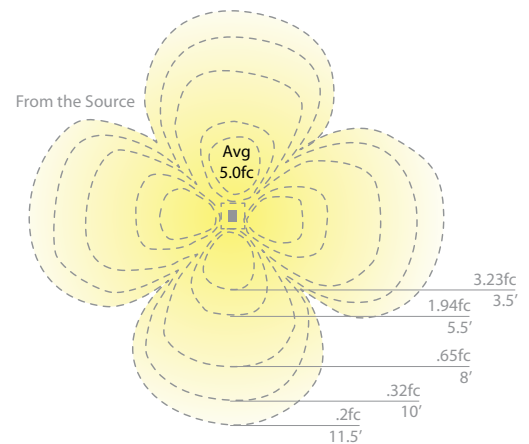

Mounting accessory included

12V



M6000-STAKE

Ordering Chart

12V

6704-27
6704-30

Fixture Finish Options:

BK Black on Aluminum
BZ Bronze on Aluminum
GT Granite on Aluminum

Example: **6704-27GT**
6 foot lead wire, and
direct-burial gel-filled wire nuts included
Transformer Required

CUBICAL

NEW FOR 2026



Featuring a tall, monolithic design with a recessed light chamber, the Cubical Bollard adds modern sophistication to walkways and architectural surroundings. Its indirect illumination and rugged aluminum body ensure long-term performance with a refined aesthetic.

- Corrosion-resistant aluminum alloy
- Factory-sealed, watertight fixture
- Soft indirect illumination

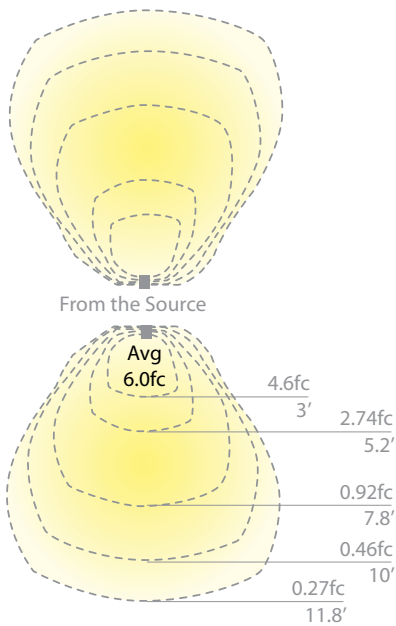
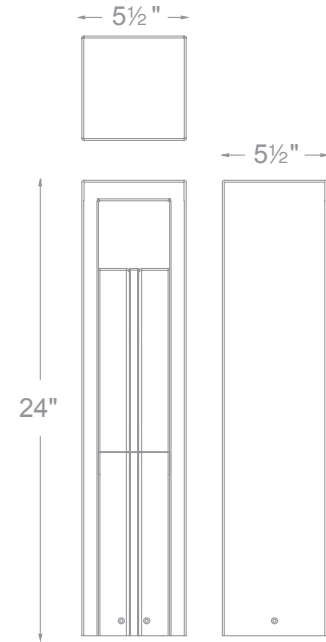

Input	Power	Brightness	Color Temp	CRI	Rated Life
9 - 15VAC	8.5W / 10VA	310lm	2700K, 3000K	90	50,000 hours

Ordering Chart

12V

6705-27
6705-30

Fixture Finish Options:

BK Black on Aluminum
BZ Bronze on Aluminum
GT Granite on Aluminum

Example: **6705-30BK**

6 foot lead wire,
and direct-burial gel-filled wire nuts included
Transformer Required

Mounting accessory included

12V



M6000-STAKE



GATE



A refined, open-frame form defines pathways and garden edges with a crisp architectural presence. Clean vertical lines surround a recessed light chamber, delivering controlled illumination from a durable, factory-sealed construction designed for consistent outdoor performance.

- Factory-sealed, watertight fixture
- Constant output for 9V-15V input
- Detachable back plate for lighting control included



Single direction illumination with back plate



Shown without plate Shown with plate

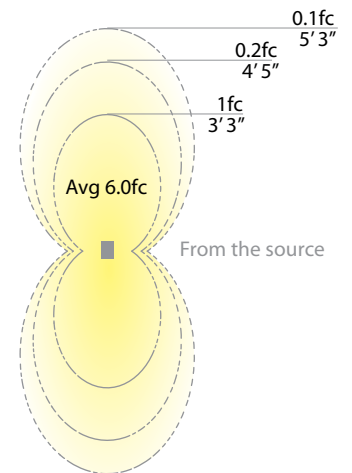
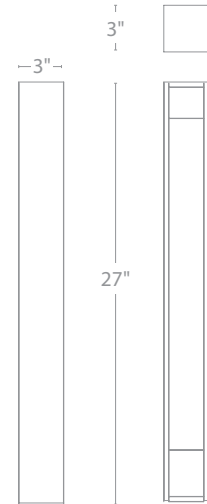

Input	Power	Brightness	Color Temp	CRI	Rated Life
9-15VAC	7.2W / 7.6VA	115lm	2700K, 3000K	90	60,000 hours

Ordering Chart

12V

Fixture Finish Options:

6651-27
6651-30

BK Black on Aluminum
BZ Bronze on Aluminum

Example: **6651-27BK**

Power stake, 6 foot lead wire, and direct-burial gel-filled wire nuts included
Transformer Required

Mounting accessory included

12V



M6000-STAKE





SCOOP 12V/120V/277V

Recommended spacing for installation:
(12V) 6611

- Residential: 5 to 6ft
- Commercial: 3 to 4ft

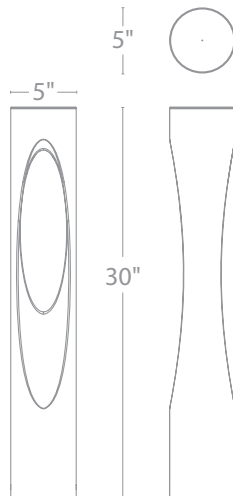
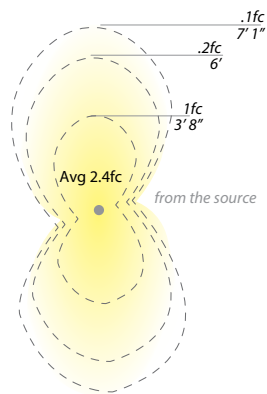

A sculpted cylindrical form features a recessed, elliptical aperture that softly defines pathways and open spaces. Designed to blend into the landscape, this bollard delivers controlled, glare-managed illumination from a durable, factory-sealed construction suited to residential and commercial environments.

- Sleek linear design blends seamlessly into pathways while providing soft, even illumination front and back
- Factory-sealed, watertight fixture
- Constant output for 9V-15V input

Recommended spacing for installation:
(120V, 277V) 6612, 6613

- Residential: 6.5 to 7.5ft
- Commercial: 4.5 to 5.5ft

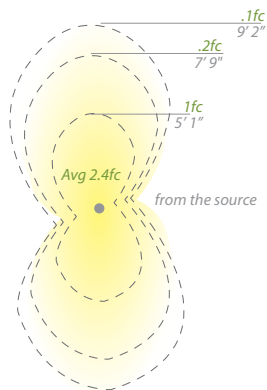

Input	Power	Brightness	Color Temp	CRI	Dimming	Rated Life
12V						
9-15VAC	7.8W / 8.5VA	Up to 180lm	2700K, 3000K	90	MLV only	60,000 hours
Transformer Required (order separately)						
120V	12.5W	Up to 350lm	2700K, 3000K	90	TRIAC or ELV	60,000 hours
277V	13.2W	Up to 370lm	2700K, 3000K	90	ELV only	60,000 hours

Mounting accessory included

12V

120V/277V



M6000-STAKE

M6610-CON-KIT

Ordering Chart

12V	120V	277V
6611-27	6612-27	6613-27
6611-30	6612-30	6613-30

Fixture Finish Options:

BK	Black on Aluminum
BZ	Bronze on Aluminum

Example: **6613-27BZ**



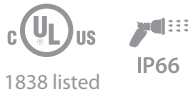

TOWER 12V/120V/277V



A structured, open-frame form creates a defined architectural presence while delivering soft, area illumination. Vertical elements surround a recessed light source, providing controlled output from a durable, factory-sealed construction suited to residential and commercial outdoor environments.

Recommended spacing for installation:
(12V) 6621

- Residential: 12 to 14.5ft
- Commercial: 4 to 6.5ft

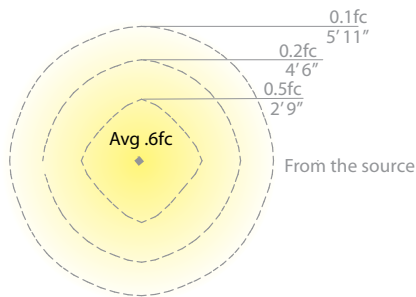

- Sleek linear design blends seamlessly into pathways while providing soft, even illumination
- Factory-sealed, watertight fixture
- Constant output for 9V-15V input

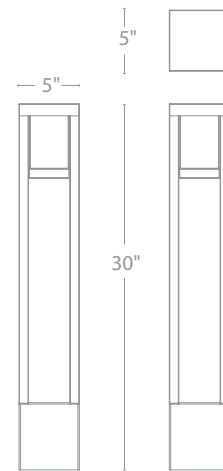

Recommended spacing for installation:
(120V, 277V) 6622, 6623

- Residential: 16 to 22ft
- Commercial: 8 to 11ft

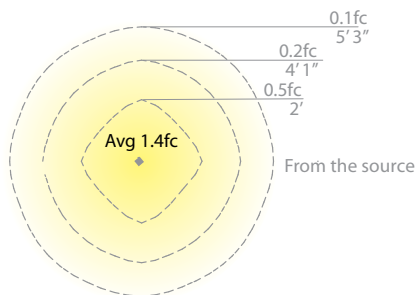

Input	Power	Brightness	Color Temp	CRI	Dimming	Rated Life
12V 9-15VAC	5.8W / 6.2VA	Up to 170lm	2700K, 3000K	90	MLV only	60,000 hours
Transformer Required (order separately)						
120V	12.5W	Up to 430lm	2700K, 3000K	90	TRIAC or ELV	60,000 hours
277V	13.2W	Up to 470lm	2700K, 3000K	90	ELV only	60,000 hours

Mounting accessory included

12V

120V/277V



M6000-STAKE

M6620-CON-KIT

Ordering Chart

12V	120V	277V	Fixture Finish Options:	
6621-27	6622-27	6623-27	BK	Black on Aluminum
6621-30	6622-30	6623-30	BZ	Bronze on Aluminum

Example: **6623-27BZ**

CHAMBER 12V/120V/277V BOLLARD



An open, vertical form frames a recessed light chamber, creating a refined architectural presence along pathways and garden edges. Clean lines and durable, factory-sealed construction support controlled illumination designed to sit quietly within the landscape.

- Sleek linear design blends seamlessly into pathways while providing soft, even illumination
- Factory-sealed, watertight fixture
- Constant output for 9V-15V input

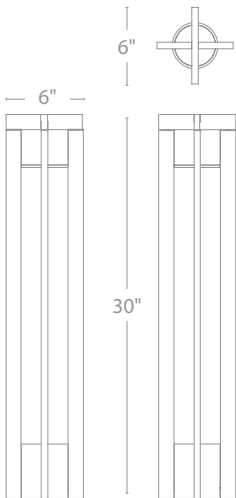

Recommended spacing for installation:
(12V) 6631

- Residential: 19.5 to 23ft
- Commercial: 13 to 15.5ft

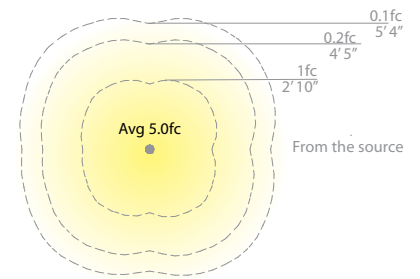

Recommended spacing for installation:
(120V, 277V) 6632, 6633

- Residential: 12.5 to 15ft
- Commercial: 8 to 10ft

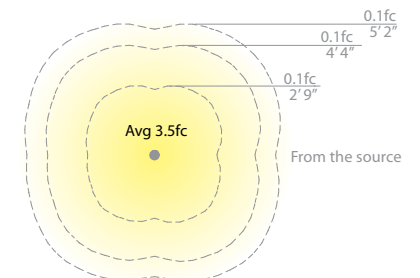

Input	Power	Brightness	Color Temp	CRI	Dimming	Rated Life
12V						
9-15VAC	5.8W / 6.2VA	Up to 150lm	2700K, 3000K	90	MLV only	60,000 hours
Transformer Required (order separately)						
120V	12.5W	Up to 400lm	2700K, 3000K	90	TRIAC or ELV	60,000 hours
277V	13.2W	Up to 450lm	2700K, 3000K	90	ELV only	60,000 hours

Ordering Chart

12V	120V	277V
6631-27	6632-27	6633-27
6631-30	6632-30	6633-30

Fixture Finish Options:

BK	Black on Aluminum
BZ	Bronze on Aluminum

Example: **6631-27BZ**

Mounting accessory included





CHAMBER 120V/277V

16", 20" & 25" OUTDOOR WALL SCNCE



Bold Mid-Century Modern look with intersecting aluminum frames and cutting-edge LED light.

- Solid aluminum construction with weather-resistant finish
- Minimal mounting hardware for easy installation
- Light engine is factory sealed for maximum protection from the elements
- No transformer or driver required

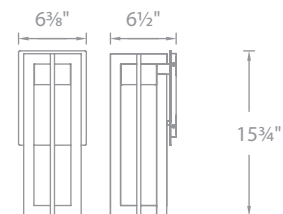

WS-W48616

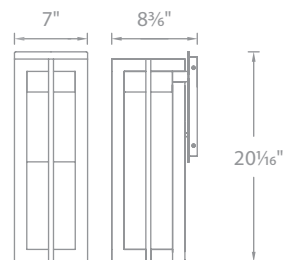

WS-W48620

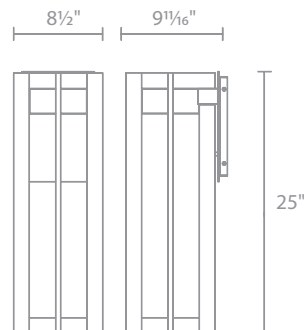

WS-W48625

Input	Power	Brightness	Color Temp	CRI	Dimming	Rated Life
16" 120V (277V special order)	12W	255lm	3000K	90	100% -10% ELV	50,000 hours
20" 120V (277V special order)	18W	519lm	3000K	90	100% -10% ELV	50,000 hours
25" 120V (277V special order)	22W	605lm	3000K	90	100% -10% ELV	50,000 hours

Ordering Chart

Sconce

Fixture Finish Options:

WS-W48616
WS-W48620
WS-W48625

BK Black
BZ Bronze

Example: **WS-W48616-BZ**

For 277V, add an "F" before the finish: **WS-W48616F-BZ**



CHAMBER 120V/277V 16" OUTDOOR PENDANT & 20" OUTDOOR POST MOUNT

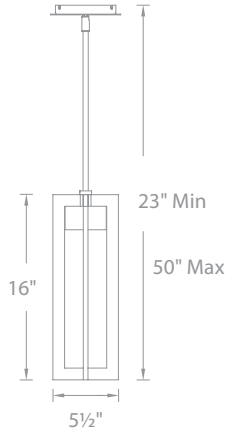

PD-W48616



PM-W48620



Input	Power	Brightness	Color Temp	CRI	Dimming	Rated Life
16"						
120V	12W	372lm	3000K	90	100% -10% ELV	50,000 hours
20"						
120V (277V special order)	17.5W	634lm	3000K	90	100% -10% ELV	50,000 hours

Ordering Chart

Pendant

PD-W48616

Post Mount

PM-W48620

Fixture Finish Options:

BK Black
BZ Bronze

Example: **PD-W48616-BK**
For 277V, add an "F" before the finish: **PD-W48616F-BK**

ARCHETYPE 12V/120V/277V

BOLLARD

A refined linear form designed to frame pathways with calm, even illumination. Open geometry creates visual lightness while directing light precisely where it's needed. Built for durability, Archetype brings quiet structure and clarity to landscape and architectural settings.

- Sleek linear design blends seamlessly into pathways while providing soft, even illumination

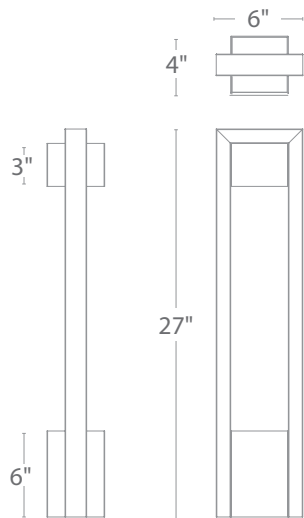

Recommended spacing for installation:
(12V) 6641

- Residential: 11.5 to 14ft
- Commercial: 7 to 9ft

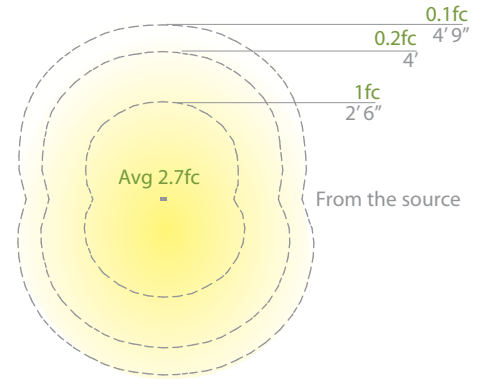

Recommended spacing for installation:
(120V, 277V) 6642, 6643

- Residential: 12.5 to 14.5ft
- Commercial: 8 to 9.5ft

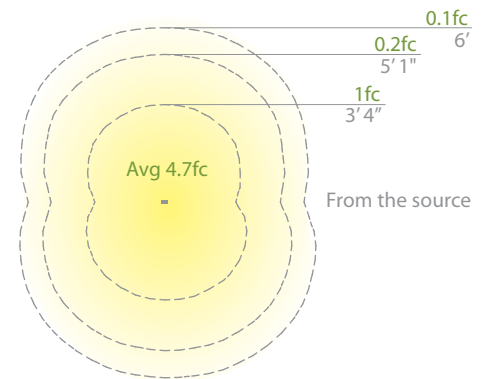

Input	Power	Brightness	Color Temp	CRI	Dimming	Rated Life
12V						
9-15VAC	5.8W / 6.2VA	Up to 195lm	2700K, 3000K	90	MLV only	60,000 hours
Transformer Required (order separately)						
120V	12.5W	Up to 470lm	2700K, 3000K	90	TRIAC or ELV	60,000 hours
277V	13.2W	Up to 550lm	2700K, 3000K	90	ELV only	60,000 hours

Ordering Chart

12V	120V	277V	Fixture Finish Options:	
6641-27	6642-27	6643-27	BK	Black on Aluminum
6641-30	6642-30	6643-30	BZ	Bronze on Aluminum

Example: **6643-27BZ**

Mounting accessory included



M6000-STAKE

M6640-CON-KIT



ARCHETYPE 120V

12", 18", & 24" OUTDOOR WALL SCNCE



A low-profile, artful design adds a distinctive, sophisticated look in any outdoor application.

- Aluminum hardware with etched glass diffuser
- No transformer or driver required

	Model	Input	Power	Brightness	Color Temp	CRI	Dimming	Rated Life
18"	WS-W13918	120V	16W	427lm	3000K	90	100% -10% ELV	54,000 hours
24"	WS-W13924	120V	22W	760lm	3000K	90	100% -10% ELV	54,000 hours
12"	WS-W15912	120V	10W	331lm	3000K	90	100% -10% ELV	54,000 hours
18"	WS-W15918	120V	13W	435lm	3000K	90	100% -10% ELV	54,000 hours
24"	WS-W15924	120V	16W	775lm	3000K	90	100% -10% ELV	54,000 hours



Ordering Chart

Scence

Fixture Finish Options:

WS-W13918
WS-W13924

WS-W15912
WS-W15918
WS-W15924

BK Black

Example: **WS-W13918-BK**

18" OUTDOOR PENDANT & 28" OUTDOOR POST MOUNT

PENDANT

- Aluminum hardware with etched glass diffuser
- No transformer or driver needed
- Three 12" and one 6" downrod included (additional rods available)

POST MOUNT

- Aluminum hardware with etched glass diffuser
- No transformer or driver needed
- Mount on 3" maximum post (not included)

	Model	Input	Power	Brightness	Color Temp	CRI	Dimming	Rated Life
18"	PD-W15918	120V	10W	379	3000K	90	100% -10% ELV	54,000 hours
28"	PM-W15928	120V	16W	382	3000K	90	100% -10% ELV	54,000 hours

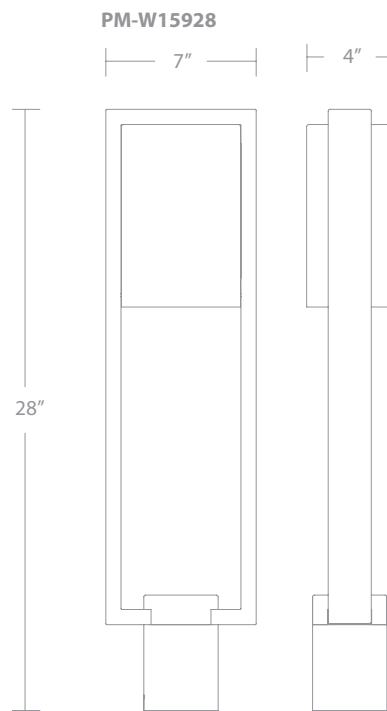
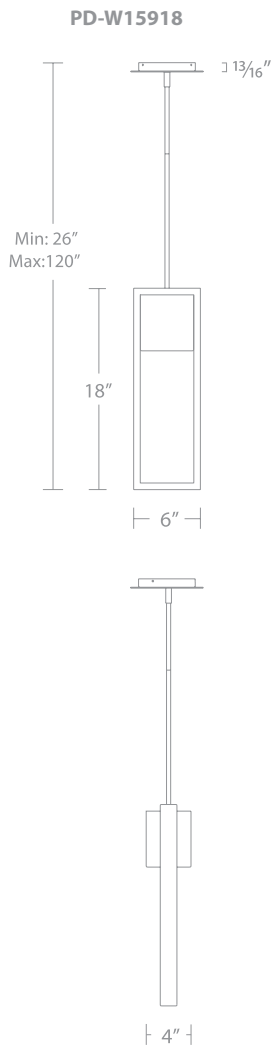

Ordering Chart

Pendant	Post Mount	Fixture Finish Options:
PD-W15918	PM-W15928	BK Black

Example: **PD-W15918-BK**

DECK & PATIO



1838 listed

- Translucent lens provides for uniform diffused light output
- 100%-10% dimming - see specification for list of tested dimmers
- Solid die-cast brass or corrosion resistant aluminum alloy
- 6' lead wire and direct burial gel filled wire nuts included

Transformer Required
See photometric data on page 167



3011

Ordering Chart

3011-27
3011-30

Fixture Finish Options:

BK Black on Aluminum
BZ Bronze on Aluminum
BBR Bronze on Brass
WT White on Aluminum

Example: **3011-27WT**

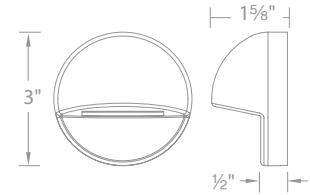

Input	Power	Brightness	Color Temp	CRI	Rated Life
9 - 15VAC	2.8W - 4.6VA	60lm	2700K, 3000K	90	50,000 hours



3021

Ordering Chart

3021-27
3021-30

Fixture Finish Options:

BK Black on Aluminum
BZ Bronze on Aluminum
BBR Bronze on Brass
WT White on Aluminum

Example: **3021-27BZ**

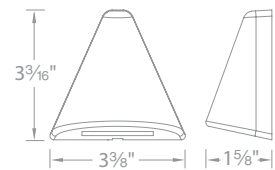

Input	Power	Brightness	Color Temp	CRI	Rated Life
9 - 15VAC	2.8W - 4.6VA	60lm	2700K, 3000K	90	50,000 hours



3031

Ordering Chart

12V

3031-27
3031-30

Fixture Finish Options:

BK Black on Aluminum
BZ Bronze on Aluminum
BBR Bronze on Brass
WT White on Aluminum

Example: **3031-27BK**

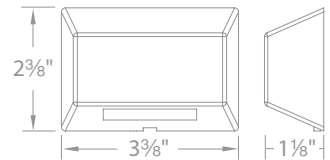

Input	Power	Brightness	Color Temp	CRI	Rated Life
9 - 15VAC	2.8W - 4.6VA	75lm	2700K, 3000K	90	50,000 hours



3041

Ordering Chart

12V

3041-27
3041-30

Fixture Finish Options:

BK Black on Aluminum
BZ Bronze on Aluminum
BBR Bronze on Brass
WT White on Aluminum

Example: **3041-27BK**

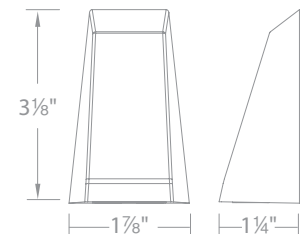

Input	Power	Brightness	Color Temp	CRI	Rated Life
9 - 15VAC	1.5W - 2VA	45lm	2700K, 3000K	90	50,000 hours





1838 listed (12V)
1598 listed (120V)

STEP LIGHTS

- Solid stainless steel construction
- Includes a spring clip for wall or step applications
- Corrosion resistant aluminum alloy, or cast stainless steel construction
- Anti-microbial white paint

SQUARE STEP LIGHTS



Ordering Chart

12V

Fixture Finish Options:

2061-27
2061-30

BS Bronze Stainless Steel
SS Stainless Steel

Example: **2061-30BS**

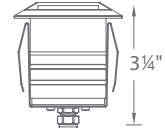
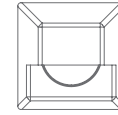

← 2 3/4" →

← 1 7/8" →

Input	Power	Brightness	Color Temp	CRI	Rated Life
9-15VAC	4.1W / 6.6VA	55lm	2700K, 3000K	85	70,000 hours

RECTANGLE STEP LIGHTS



Ordering Chart

12V

Fixture Finish Options:

4011-27
4011-30
4011-AM

BZ Bronze on Aluminum
BK Black on Aluminum
BBR Bronze on Brass
GH* Graphite
SS** Cast Stainless Steel
WT White on Aluminum

Example: **4011-30BZ**

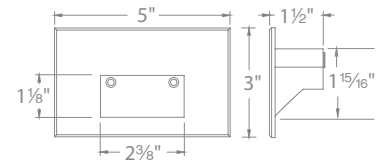

120V

WL-LED100-27
WL-LED100-30
WL-LED100-AM

Ordering Chart

12V

Fixture Finish Options:

4021-27
4021-30
4021-AM

BZ Bronze on Aluminum
BK Black on Aluminum
GH* Graphite
SS** Cast Stainless Steel
WT White on Aluminum

Example: **4021-30BK**

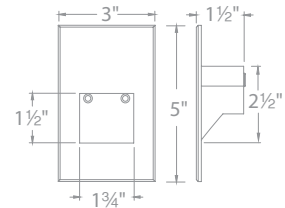

Input	Power	Brightness	Color Temp	CRI	Rated Life
12V					
9-15VAC	2W / 3.1VA	Up to 38 lm	2700K & 3000K & Amber	90	60,000 hours

Transformer Required (order separately)

120V

110-120VAC	3.5W	Up to 65 lm	3000K	90	54,000 hours
------------	------	-------------	-------	----	--------------

*Graphite finish is only available in 120V

**Cast Stainless Steel finish is only available in 3000K and Amber colors



ENDURANCE[®]

BRICK LIGHTS



- Option to easily retrofit existing incandescent brick lights by others.
- Factory-sealed LED light engine
- Die-cast aluminum construction
- 120V direct wire - no driver needed

LOW GLARE BRICK LIGHT

WL-5205 Louver



Ordering Chart

120V

Fixture Finish Options:

WL-5205-30

- aBK** Architectural Black
- aBZ** Architectural Bronze
- aGH** Architectural Graphite
- aWT** Architectural White

Example: **WL-5205-30-ABK**

Input	Power	Brightness	Color Temp	CRI	Dimming	Rated Life
120V	5.5W	Up to 110 lm	3000K	90	100% - 10% ELV	80,000 hours

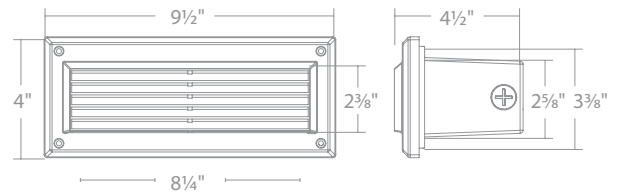

OPEN ILLUMINATION BRICK LIGHT

WL-5105 Opal



Input	Power	Brightness	Color Temp	CRI	Dimming	Rated Life
120V	5.5W	Up to 45 lm	3000K	90	100% - 10% ELV	80,000 hours

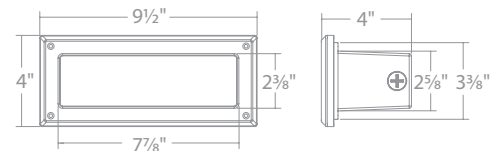

Ordering Chart

120V

Fixture Finish Options:

WL-5105-30

- aBK** Architectural Black
- aBZ** Architectural Bronze
- aGH** Architectural Graphite
- aWT** Architectural White

Example: **WL-5105-30-AWT**



SURFACE MOUNTED STEP LIGHTS

LOW PROFILE INSTALLATION

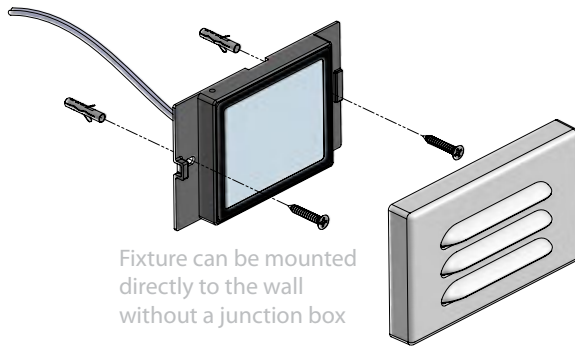

Fixture can be mounted directly to the wall without a junction box

- Slim, low profile design-surface mount installation
- Junction box not required
- Die-cast aluminum or die-cast brass
- Invisible hardware
- 6' lead wire included
- Compatible with WAC® 12V Landscape Transformers



Ordering Chart

12V

Fixture Finish Options:

4901-27
4901-30

BZ Bronze on Aluminum
BK Black on Aluminum
BBR Bronze on Brass
WT White on Aluminum

Example: **4901-27BK**

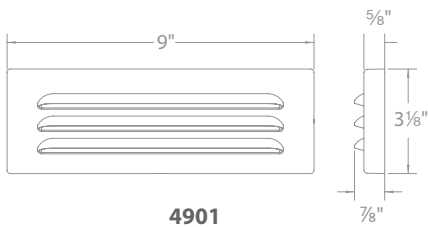

4901

Input	Power	Brightness	Color Temp	CRI	Rated Life
9-15V	8W/12VA	100lm	2700K, 3000K	90	70,000 hours

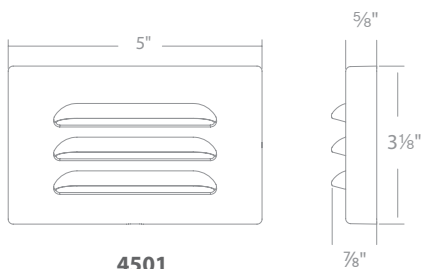

4501

Input	Power	Brightness	Color Temp	CRI	Rated Life
9-15V	4W/5.6VA	55lm	2700K, 3000K	90	70,000 hours



Ordering Chart

12V

Fixture Finish Options:

4501-27
4501-30

BZ Bronze on Aluminum
BK Black on Aluminum
BBR Bronze on Brass
WT White on Aluminum

Example: **4501-30WT**

12V RECTANGULAR STEP & WALL LIGHTS

Input: 12V
 Brightness: Up to 17 lm
 Dimming: 100%-10% MLV
 Rated Life: 60,000 hours

- The louvered design shields the light source to reduce glare and enhance visual comfort.
- Constructed of die-cast aluminum with an abrasion-resistant powder-coated finish.

Step Light	Model	Voltage	Wattage	Color Temp	CRI	Finish
	4051-27	12V	2W / 3.1VA	2700K	90	BK Black on AL
	4051-30			3000K		BZ Bronze on AL
	4051-AM			Amber		WT White on AL



4051

Example: **4051-27-BZ**

Step Light	Model	Voltage	Wattage	Color Temp	CRI	Finish
	4061-27	120V	2W / 3.1VA	2700K	90	BK Black on AL
	4061-30			3000K		BZ Bronze on AL
	4061-AM			Amber		WT White on AL



4061

Example: **4061-30-BK**

Input: 12V
 Brightness: Up to 4 lm
 Dimming: 100%-10% MLV
 Rated Life: 60,000 hours

- Features a fluid, decorative profile with full cut-off illumination.
- Constructed of die-cast aluminum with an abrasion-resistant powder-coated finish or a plated brushed nickel finish.

Step Light	Model	Voltage	Wattage	Color Temp	CRI	Finish
	4031-27	12V	2W / 3.1VA	2700K	90	BK Black on AL
	4031-30			3000K		BZ Bronze on AL
	4031-AM			Amber		WT White on AL



4031

Example: **4031-27-BZ**

Transformer Required

Step Light	Model	Voltage	Wattage	Color Temp	CRI	Finish
	4041-27	12V	2W / 3.1VA	2700K	90	BK Black on AL
	4041-30			3000K		BZ Bronze on AL
	4041-AM			Amber		WT White on AL



4041

Example: **4041-30-WT**

Input: 12V
 Brightness: Up to 2 lm
 Dimming: 100%-10% ELV
 Rated Life: 60,000 hours



- The geometric design provides focused downward illumination
- Constructed of die-cast aluminum with an abrasion-resistant powder-coated finish..



Step Light	Model	Voltage	Wattage	Color Temp	CRI	Finish
	4091-27	12V	2W / 3.1VA	2700K	90	BK Black on AL
	4091-30			3000K		BZ Bronze on AL
	4091-AM			Amber		WT White on AL

Example: **4091-30-BK**

Input: 12V
 Brightness: Up to 28 lm
 Dimming: 100%-10% MLV
 Rated Life: 60,000 hours

- Tempered glass diffuses light for even illumination.
- Constructed of die-cast aluminum.
- Available with an abrasion-resistant powder-coated finish or a marine-grade stainless steel option.
- Mounts vertically or horizontally.



Step Light	Model	Voltage	Wattage	Color Temp	CRI	Finish
	4071-27	12V	2W / 3.1VA	2700K	90	BK Black on AL
	4071-30			3000K		BZ Bronze on AL
	4071-AM			Amber		SS Stainless Steel
						WT White on AL

Example: **4071-27-SS**

120V & 277V RECTANGULAR STEP & WALL LIGHTS

Input: 120V, 277V
 Brightness: Up to 4 lm
 Dimming: 100%-10% ELV (120V only)
 Rated Life: 50,000 hours

- Features a fluid, decorative profile with full cut-off illumination.
- Constructed of die-cast aluminum with an abrasion-resistant powder-coated finish or a plated brushed nickel finish.
- Title 24 compliant (120V only).

Step Light	Model	Voltage	Wattage	Color Temp	CRI	Finish
	WL-LED110-C	120V	3.5W	2700K	90	BK Black on AL
	WL-LED110-AM			3000K		BN* Brushed Nickel
	WL-LED110F-C	277V	3W	Amber		BZ Bronze on AL
	WL-LED110F-AM				WT White on AL	
Example: WL-LED110-C-WT	Transformer Required					



WL-LED110-C-WT

Step Light	Model	Voltage	Wattage	Color Temp	CRI	Finish
	WL-LED210-C	120V	3.5W	3000K	90	BK Black on AL
	WL-LED210-AM			Amber		BN* Brushed Nickel
	WL-LED210F-C	277V	3W			BZ Bronze on AL
	WL-LED210F-AM				WT White on AL	
Example: WL-LED210-C-BK	*BN finish is damp location listed and is not warranted for contact with harsh chemicals or exterior installations.					



WL-LED210-C-BK

Input: 120V, 277V
 Brightness: Up to 36 lm
 Dimming: 100%-10% ELV (120V only)
 Rated Life: 50,000 hours

- The louvered design shields the light source to reduce glare and enhance visual comfort.
- Constructed of die-cast aluminum with an abrasion-resistant powder-coated finish.

Step Light	Model	Voltage	Wattage	Color Temp	CRI	Finish
	WL-LED120-C	120V	3.5W	3000K	90	BK Black on AL
	WL-LED120-AM			Amber		BZ Bronze on AL
	WL-LED120F-C	277V	3W			WT White on AL
	WL-LED120F-AM					
Example: WL-LED120-C-BK						



WL-LED-120-C-BZ

Step Light	Model	Voltage	Wattage	Color Temp	CRI	Finish
	WL-LED220-C	120V	3.5W	3000K	90	BK Black on AL
	WL-LED220-AM			Amber		BZ Bronze on AL
	WL-LED220F-C	277V	3W			WT White on AL
	WL-LED220F-AM					
Example: WL-LED220-C-BZ						



WL-LED-220-C-BZ

Input: 120V, 277V
 Brightness: Up to 40 lm
 Dimming: 100%-10% ELV (120V only)
 Rated Life: 50,000 hours

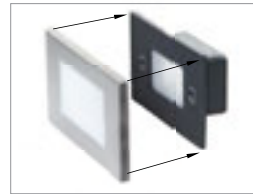

IP66-rated, self-contained fixture offered with multiple faceplate options. It fits into a standard switch box or a 2" x 4" junction box with minimum interior dimensions of 3"L x 2"W x 2.5"D.

- Tempered glass diffuses light for even illumination.
- Constructed of die-cast aluminum.
- Available with an abrasion-resistant powder-coated finish or a marine-grade stainless steel option.
- Title 24 compliant (120V only).
- Mounts vertically or horizontally.



Step Light

Model Voltage Wattage Color Temp CRI Finish

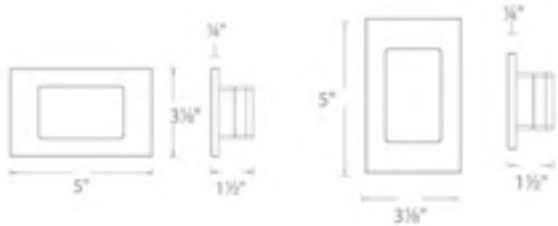

WL-LED130-C
WL-LED130-AM

120V 3.5W

3000K
 Amber

90

BK Black on AL
BZ Bronze on AL
SS Stainless Steel
WT White on AL

WL-LED130F-C
WL-LED130F-AM

277V 3W

Example: **WL-LED130-C-SS**

Input: 120V, 277V
 Brightness: Up to 3 lm
 Dimming: 100%-10% ELV (120V only)
 Rated Life: 50,000 hours

- The geometric design provides focused downward illumination
- Constructed of die-cast aluminum with an abrasion-resistant powder-coated finish.
- Title 24 compliant (120V models only).



Step Light

Model Voltage Wattage Color Temp CRI Finish

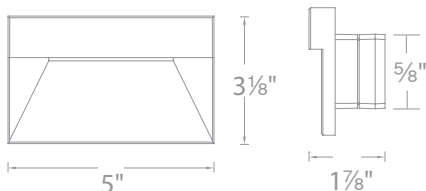

WL-LED140-C
WL-LED140-AM

120V 3.5W

3000K
 Amber

90

BK Black on AL
BZ Bronze on AL
WT White on AL

WL-LED140F-C
WL-LED140F-AM

277V 3W

Example: **WL-LED140-C-BK**

12VAC OUTDOOR



- Seamless integration with standard magnetic transformers or landscape lighting
- Compatible with MLV dimmers for adjustable brightness
- COB technology ensures uniform, dot-free illumination
- Constructed with double-insulated, UV-stabilized silicone for durability
- Easy-to-use push-in connectors for simple, hassle-free installation
- Cuttable every 2 inches with end-caps to maintain integrity
- Versatile spool lengths: 1ft, 5ft, 10ft, 20ft, and 35ft
- Energy-efficient, consuming only 1.5W per foot while delivering 100 lumens per foot
- High color fidelity with a 90+ color rendering index
- Available in warm white tones of 2700K and 3000K

Max Run Length with WAC cable Accessories

Total Length of Lead Wire Between Magnetic Transformer and Tape	12 VAC	13 VAC	14 VAC	15 VAC
	With 5A Fuse Lead Wire			
6ft	37ft	37ft	35ft	35ft
9ft	37ft	37ft	35ft	35ft
12ft	30ft	32ft	32ft	30ft
18ft	25ft	28ft	30ft	30ft
24ft	21ft	27ft	29ft	28ft
30ft	20ft	26ft	28ft	27ft
40ft	18ft	25ft	27ft	27ft

Note: Maximum run lengths shown guarantee 60% lumen maintenance at the end of the run

Ordering Chart

8012	1 foot	
8052	5 feet	
8102	10 feet	27
8202	20 feet	30
8352	35 feet	

Fixture Finish:

WT White

Example: **8202-30WT**
Transformer Required

See Accessories page for more detail

Input	Power	Brightness	Color Temp	CRI	Rated Life	Cutting Length
12VAC	1.5W per foot	100 lm per foot	2700K, 3000K	90+	50,000 hours	2 inches

Accessories

Joiner Cable	L&J Connector	Y Connector	X Connector	End Cap	5' Clear Channel	Lead Wire with 5A Fuse
T24-OD-IC6-WT T24-OD-IC12-WT T24-OD-IC72-WT T24-OD-IC120-WT	T24-OD-L-WT	T24-OD-Y-WT	T24-OD-X-WT	T24-OD-EC-WT	T24-OD-CH5-CL	8002-06WT 8002-10WT

Surface Mounting Clip	Edge Mounting Clip	Underside Mounting Clip
T24-OD-C1-WT	T24-OD-C2-WT	T24-OD-C3-WT

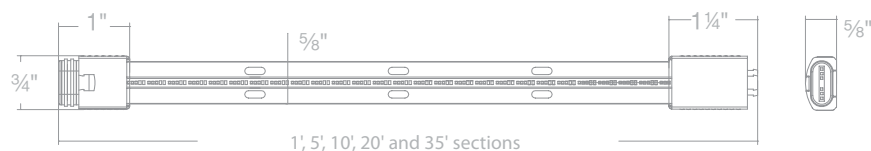



24VDC OUTDOOR



- May be cut every 4 inches
- Beam Spread: 115°
- Multiple roll lengths offered
- Equal brightness from end to end
- Protection against water spray, dust with silicone jacket (IP65)
- 100 ft max distance between the power supply and beginning of InvisiLED®



Ordering Chart		Fixture Finish:	System	Max Run
	01 1 foot	Black	T24-OD1	80ft
	05 5 feet			
T24-OD1	10 10 feet			
T24-OD2	20 20 feet			
	40 40 feet			
	80* 80 feet*			

*T24-OD2 not available in 80 feet
 Example: **T24-OD2-01-27**
 See Accessories page for more detail



Input	Power	Brightness	Color Temp	CRI	Rated Life
24VDC	1.2W/ft	T24-OD1	2700K, 3000K, 4000K	90	50,000 hours
	2.4W/ft	T24-OD2			
					up to 200 lm per foot





Power Supply for TRIAC/ELV Dimming

Model	Input	Output	Dimmable	
 PS-24DC-U96R-WE	120V-277VAC	24VDC, 96W	ELV / TRIAC	Remote Wet Location Includes a 6 foot lead wire
 PS-24DC-A96P-WE	120V	24VDC, 96W	N/A	Portable Wet Location Includes a 6 foot lead wire 120V input power cord ready

Power Supply for Wireless/DMX Control

	Model	Input	Output	Dimension	
	PS-24DC-U96R-IP67	120/277VAC	24VDC, 96W	8 3/8" x 2 13/16" x 1 11/16"	Remote Power Supply - Wet Location IP67 Class 2 Output Power Supply. Includes a 6 foot lead wire.
	PS-24DC-U96R-IP45	120/277VAC	24VDC, 96W	8 13/16" x 2 1/16" x 1 1/4"	Remote Power Supply - Damp Location IP45 Class 2 Output Power Supply. Includes a 6 foot lead wire.
	PS-24DC-A96P-OD	120VAC	24VDC, 96W	8 3/8" x 2 13/16" x 1 11/16"	Portable Power Supply - Wet Location IP67 Class 2 Output Power Supply. Includes a 6 foot lead wire.

Controller

	T24-OD-CTR	24VDC, 96W Max from power supply 3ft input cable included	24VDC, 90W Max 3ft output cable included	5" x 3 1/2" x 1 1/2"	Outdoor Wireless DMX Controller Allows outdoor tape to be wirelessly controlled through MyWAC app, WallStation, or DMX. IP65 wet rated *Wi-Fi network is required to operate the system. This controller consumes 6W power Max
	LED-WCT-WT	120-230VAC	N/A	4 5/8" x 2 3/4" x 1 5/8"	WallStation Multi-scene selection/Dimming Control, dedicated Off button/Suitable for standard single NEMA wall box Setup and configuration via MyWAC mobile application. Wi-Fi required.

Accessories

Invisiled Outdoor Joiner Cable	Invisiled Outdoor Lead Wire	Invisiled Outdoor Power Connector Kit with Wire Jacket and Silicone Sealant	Invisiled Outdoor Tape to Tape Y Connector	Wireless Controller to InvisiLED Outdoor Tape joiner Cable	Invisiled Outdoor Surface Mount Clear Channel	Silicone Sealant
T24-WE-IC-002-BK T24-WE-IC-006-BK T24-WE-IC-012-BK T24-WE-IC-036-BK T24-WE-IC-072-BK T24-WE-IC-144-BK T24-WE-IC-240-BK	T24-WE-B012-BK T24-WE-B072-BK	T24-WE-EX2-006-BK	T24-WE-Y-BK	T24-WE-EX-CTR	T24-WE-CH5	T24-WE-SI-45
Invisiled Outdoor Edge Mounting Clip.	Invisiled Outdoor Surface Mounting Clip	Invisiled Outdoor Underside Mounting Clip.	Wet Rated Tape End Cap with Silicone Sealant	DMX Signal Cable - Universe	DMX Signal Cable - Satellite	
LED-TO24-C2	LED-TO24-C1	T24-WE-C3	T24-WE-EC	T24-OD-MW60 T24-OD-MW120	T24-OD-SW60 T24-OD-SW120	

Example installation for Wireless and DMX control

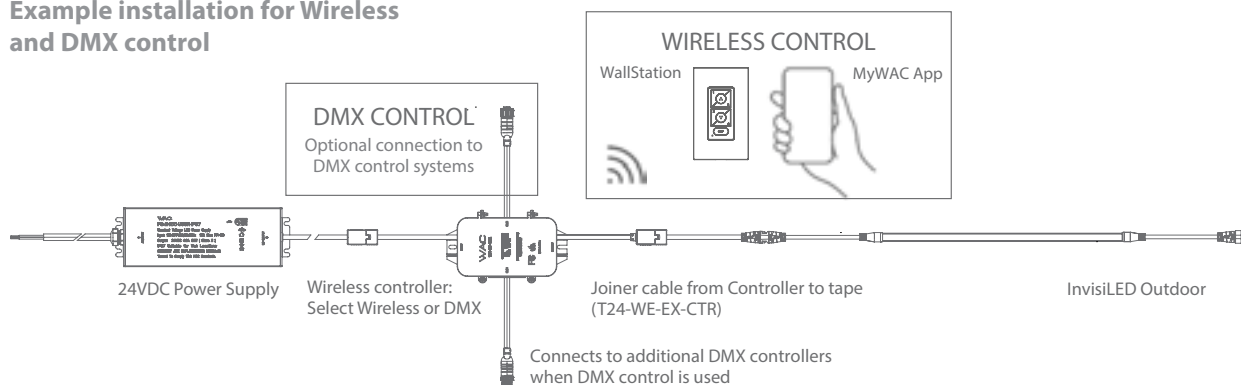

24VDC OUTDOOR PRO+



- Dual dimming options: traditional and wireless DMX control
- Smart system compatibility with MyWAC app and home assistants
- COB technology ensures uniform, dot-free illumination
- IP66-rated silicone jacket for outdoor durability
- Easy-to-use push-in connectors for quick installation
- Cuttable every 2 inches with end-caps for a clean finish after cutting
- High-intensity white LEDs with a CRI > 90
- Available in 4 CCT options to blend into any architecture

Ordering Chart

	01	1 foot		
	05	5 feet	27P	2700K
T24-OD1	10	10 feet	30P	3000K
T24-OD2	20	20 feet	35P	3500K
	30*	30 feet	40P	4000K
	40**	40 feet		

Fixture Finish:

White

Example: **T24-OD1-20-30P**

* Only available in the T24-OD2 model

** Only available in the T24-OD1 model

See Accessories page for more detail

Input	Power	Brightness	Color Temp	CRI	Rated Life	Cutting Length
24VDC	1.2W/ft 2.3W/ft	T24-OD1 T24-OD2	up to 100 lm per foot up to 200 lm per foot	2700K, 3000K, 3500K, 4000K	90	50,000 hours



Max Run Length

Total Length of Lead Wire from Power Supply/Controller to tape	T24-OD1 (100lm/ft)		T24-OD2 (200lm/ft)	
	TRIAC/ELV Dimming: Power Supply	Wireless Control: Power Supply + Wireless DMX Controller	TRIAC/ELV Dimming: Power Supply	Wireless Control: Power Supply + Wireless DMX Controller
6ft	40ft	40ft	30ft	30ft
9ft	40ft	40ft	30ft	26ft
12ft	40ft	38ft	26ft	22ft
18ft	33ft	29ft	20ft	17ft
24ft	26ft	24ft	16ft	14ft
30ft	22ft	20ft	13ft	12ft
40ft	17ft	16ft	10ft	9ft



Note: Calculation based on 6' lead wire between power supply and controller



Power Supply

	Model	Input	Output	Dimension	Dimming	
	PS-24DC-U96R-IP67	120/277VAC	24VDC, 96W	8 3/8" x 2 13/16" x 1 1/16"	TRIAC/ELV	Remote Power Supply - Wet Location IP67 Class 2 Output Power Supply. Includes a 6 foot lead wire.
	PS-24DC-U96R-IP45	120/277VAC	24VDC, 96W	8 13/16" x 2 1/16" x 1 1/4"	TRIAC/ELV	Remote Power Supply - Damp Location IP45 Class 2 Output Power Supply. Includes a 6 foot lead wire.
	PS-24DC-A96P-OD	120VAC	24VDC, 96W	8 3/8" x 2 13/16" x 1 1/16"	N/A	Portable Power Supply - Wet Location IP67 Class 2 Output Power Supply. Includes a 6 foot lead wire.

Controller

	T24-OD-CTR	24VDC, 96W Max from power supply 3ft input cable included	24VDC, 90W Max 3ft output cable included	5" x 3 1/2" x 1 1/2"		Outdoor Wireless DMX Controller Allows outdoor tape to be wirelessly controlled through MyWAC app, WallStation, or DMX. IP65 wet rated *Wi-Fi network is required to operate the system. This controller consumes 6W power Max
	LED-WCT-WT	120-230VAC	N/A	4 5/8" x 2 3/4" x 1 5/8"		WallStation Multi-scene selection/Dimming Control, dedicated Off button/Suitable for standard single NEMA wall box Setup and configuration via MyWAC mobile application. Wi-Fi required.

Important Dimming Notice: Must select either the Outdoor Wireless DMX Controller (T24-OD-CTR) for wireless operation or a TRIAC/ELV dimmer for dimming capabilities. Please be aware that these control options cannot be used simultaneously—the LED tape cannot be dimmed using both the TRIAC/ELV dimmer and wirelessly from the mobile app or WallStation. Choose one method to ensure optimal functionality and avoid operational conflicts.

Accessories

Joiner Cable	L&J Connector	Y Connector	X Connector	End Cap	5' Clear Channel	Surface Mounting Clip
T24-OD-IC6-WT T24-OD-IC12-WT T24-OD-IC72-WT T24-OD-IC120-WT	T24-OD-L-WT	T24-OD-Y-WT	T24-OD-X-WT	T24-OD-EC-WT	T24-OD-CH5-CL	T24-OD-C1-WT
Edge Mounting Clip	Underside Mounting Clip	DMX Signal Cable - Universe	DMX Signal Cable - Satellite			
T24-OD-C2-WT	T24-OD-C3-WT	T24-OD-MW60 T24-OD-MW120	T24-OD-SW60 T24-OD-SW120			

Example installation for Wireless and DMX control

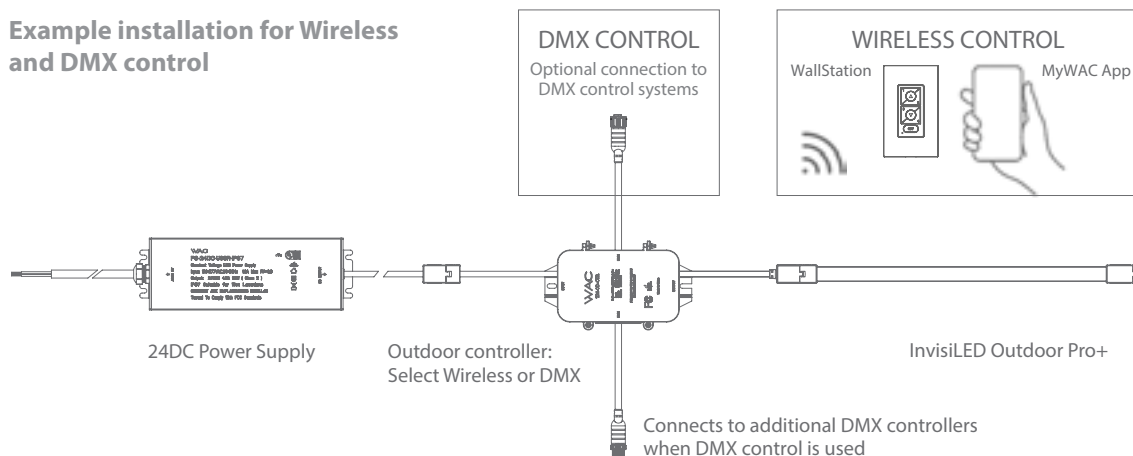

24VDC OUTDOOR RGBWW

RGBWW LANDSCAPE TAPE LIGHTING



- Comprehensive smart home system compatibility
- Advanced IP66 rated protective silicone jacket
- Effortless connectivity: plug and play connectors offer easy, hassle-free installation
- Cuttable every 2 inches and sealable with end caps
- Vivid full color spectrum
- Precisely tunable white light for perfect ambiance
- High-Definition vivid white illumination with superior CRI

Input	Power	Lm/ft	Color Temp	CRI	Rated Life	Cutting Length
24VDC	3.57W/ft *	White	100 lm/ft	R/G/B	90	50,000 hours
	5.5W/ft **	Red	9.7 lm/ft	2700K-5000K		
		Green	34 lm/ft			
		Blue	10.4 lm/ft			

*MyWAC App/Wallstation Control

**DMX Control

Ordering Chart

24VDC

01	1 foot		
05	5 feet		
T24-OD1 10	10 feet	CC	White
15	15 feet		
25	25 feet		

Fixture Finish:

White

Total Length of Lead Wire* Between Controller to Tape

- 3ft
- 6ft
- 9ft
- 12ft
- 18ft
- 24ft
- 30ft
- 40ft

Example: **T24-OD1-01-CC**



See Accessories page for more detail

Note: Calculation based on 6' lead wire* between power supply and controller

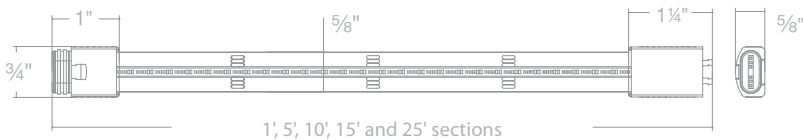

*All lead wire usage in the system assumes WAC Joiner cable accessories



Power Supply

	Model	Input	Output	Dimension	
	PS-24DC-U96R-IP67	120/277VAC	24VDC, 96W	8 3/8" x 2 13/16" x 1 11/16"	Remote Power Supply - Wet Location IP67 Class 2 Output Power Supply. Includes a 6 foot lead wire.
	PS-24DC-U96R-IP45	120/277VAC	24VDC, 96W	8 13/16" x 2 1/16" x 1 1/4"	Remote Power Supply - Damp Location IP45 Class 2 Output Power Supply. Includes a 6 foot lead wire.
	PS-24DC-A96P-OD	120VAC	24VDC, 96W	8 3/8" x 2 13/16" x 1 11/16"	Portable Power Supply - Wet Location IP67 Class 2 Output Power Supply. Includes a 6 foot lead wire.

Controller

	T24-OD-CTR	24VDC, 96W Max from power supply 3ft input cable included	24VDC, 90W Max 3ft output cable included	5" x 3 1/2" x 1 1/2"	Outdoor Wireless DMX Controller Allows outdoor tape to be wirelessly controlled through MyWAC app, WallStation, or DMX. IP65 wet rated *Wi-Fi network is required to operate the system. This controller consumes 6W power Max
	LED-WCT-WT	120-230VAC	N/A	4 5/8" x 2 3/4" x 1 5/8"	WallStation Multi-scene selection/Dimming Control, dedicated Off button/Suitable for standard single NEMA wall box Setup and configuration via MyWAC mobile application. Wi-Fi required.

Accessories

Joiner Cable	L & J Connector	Y Connector	X Connector	End Cap	5' Clear Channel	Surface Mounting Clip
T24-OD-IC6-WT T24-OD-IC12-WT T24-OD-IC72-WT T24-OD-IC120-WT	T24-OD-L-WT	T24-OD-Y-WT	T24-OD-X-WT	T24-OD-EC-WT	T24-OD-CH5-CL	T24-OD-C1-WT
Edge Mounting Clip	Underside Mounting Clip	DMX Signal Cable - Universe	DMX Signal Cable - Satellite			
T24-OD-C2-WT	T24-OD-C3-WT	T24-OD-MW60 T24-OD-MW120	T24-OD-SW60 T24-OD-SW120			

Example installation for Wireless and DMX control

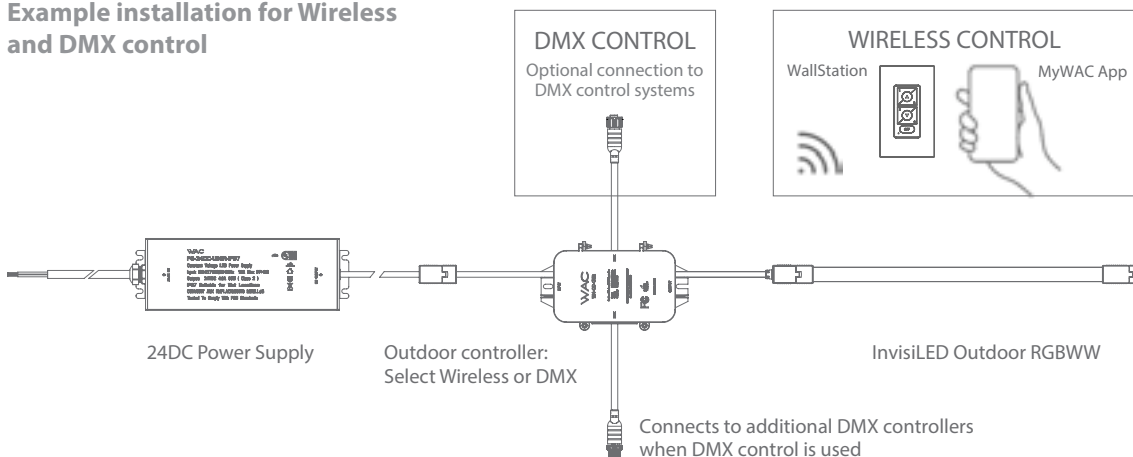

OUTDOOR TRACK



X-10 TRACK HEAD LED ADJUSTABLE BEAM



**PATENT
PENDING**

Power: 12W / 12VA
 Input: 12V
 Dimming: 100%-5%, MLV
 Rated Life: 50,000 hours
 Construction: Die-cast Aluminum
 Standards: ETL & cETL Wet Location Listed

- Continuously adjustable beam angles from 20° - 70° with indexed adjustment markings
- Built-in voltage drop compensation provides consistent output
- Fixtures are polarity agnostic and may be installed to track in either orientation
- High power factor (PF) electronics for optimized VA rating
- Accommodates one lens accessory and one glare control accessory



	Model	Color Temp	CRI	Beam Angle	Max Lumens	Max CBCP	Finish	
	X-10	27 2700K	90	20° - 70°	630	2230	BK WT	Black
		30 3000K						White

Example: **X-10-30BK**

ACCESSORY HOLDER

LENS-X10-HLD-BK

Required for use with lens and glare control accessory



GLARE CONTROL ACCESSORIES

LENS-16-HCL

Honeycomb Louver

LENS ACCESSORIES

LENS-16-AMB

Amber

LENS-16-BLU

Blue

LENS-16-GRN

Green

LENS-16-RED

Red

LENS-16-FR

Frosted











LENS-16-SPR

Spread Lens

LENS-16-BEL

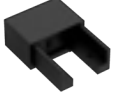
Beam Elongating

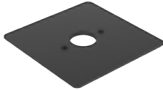
OUTDOOR TRACK COMPONENTS

Track	Model	Finish	Dimensions	Description	
	XT4 XT8	BK Black WT White	48" x 1 3/8" x 1/16" 96" x 1 3/8" x 1/16"	Outdoor Track Constructed from powder-coated aluminum for durability. Requires 10-gauge landscape lighting cable for installation. Supplied with mounting hardware, one pair of joiners, and one end cap. Pre-drilled mounting holes with 8" spacing.	
Example: XT4-BK					
Transformers & Wires	Model	Finish	Dimensions	Max Power	Description
	9075-TRN 9150-TRN 9300-TRN 9600-TRN	SS Stainless Steel	14" x 5 3/8" x 5 5/8" 18 7/8" x 6 3/4" x 6 1/4" 18 7/8" x 6 3/4" x 6 1/4" 14 1/2" x 10 1/8" x 6"	75W 150W 300W 600W (2x300W outputs)	Outdoor-Rated Stainless Steel Transformer with 12–15V terminals, knockout for power and photo sensor connections, and a 3-prong timer outlet.
	9100-10G 9250-10G	BK Black	100 ft x 7/16" x 3/16" 250 ft x 7/16" x 3/16"		12V Landscape Lighting 10-Gauge Cable Available in 100 ft and 250 ft lengths. Required for each track installation. Determine the distance from the transformer to the end of the track run to select the appropriate cable length.
Example: 9300-TRN-SS					
Connectors & Hardware	Model	Finish	Dimensions	Description	
	X-FE	BK Black WT White	4" x 1 3/8" x 1/16"	Feed End Used to side or top feed direct wiring to track sections. A canopy plate is required when using with a standard junction box.	
	X-L	BK Black WT White	4" x 4" x 1/16"	L Connector Joins 2 track sections 90°. May be top fed for direct wiring to track sections.	
	X-FLX	BK Black WT White	12 5/8" x 1 3/8" x 1/16"	Flexible Connector Joins 2 track sections at variable angles. Use as a transition from wall-to-wall, wall-to-ceiling, and ceiling-to-ceiling.	
	X-EC	BK Black WT White	2" x 1 3/8" x 1/16"	End Cap Additional end cap. Use at end of track run or open patterns to complete the installation.	
	X-JOIN	BK Black WT White	1 7/16" x 3/16" x 9/16"	I Joiner Additional joiner. Joins two track sections.	
	X-CP	BK Black WT White	5" x 5" x 3/16"	Canopy Plate Covers a junction box. Use with Feed End or L Connector.	
Example: X-L-BK					
Track Cover	Model	Finish	Dimensions	Description	
	X-COV	BK Black WT White	48" x 1 3/8" x 3/16"	Track Cover Optional field cuttable UV-resistant polycarbonate cover designed to fit channels for a finished look. Two 48" sections included.	
Example: X-COV-BK					

120-VOLT LANDSCAPE LIGHTING

From accent and wall wash to inground and bollard lighting, our line voltage landscape lighting uses the standard 120-volt electrical system without a transformer to power our fixtures and enhance the safety, security, and beauty of your property. Commonly used in large outdoor spaces and to highlight specific features in commercial areas, line voltage luminaires provide a robust and consistent light source. Energy efficient, LED Line voltage landscape lighting enables simpler, straightforward layouts to illuminate any evening scene with romance and functionality.



ACCENT 120V

See page 47



GRAND ACCENT 120V

See page 44



WALL WASH 120V

See page 56



ADJUSTABLE BEAM
WALL WASH 120V

See page 54



GRAND INGROUND 120V

See page 59



3" INGROUND 120V

See page 58

BOLLARDS 120V-277V

SCOOP
See page 109



CHAMBER
See page 112



TOWER
See page 111



ARCHETYPE
See page 116



GRAND LEDGE 42" & 30"
See page 97



WL-LED100
See page 122



WL-LED200
See page 122



WL-LED110
See page 128



WL-LED210
See page 128



WL-LED120
See page 128



WL-LED220
See page 128



WL-LED130
See page 129



WL-LED130
See page 129



WL-LED140
See page 129

ENDURANCE® LED WALL PACK



Input: 120V
Dimming: 100% - 10% ELV
Rated Life: 54,000 hours

- Breathable waterproof technology and factory-sealed
- LED light engine ensures fixture can maintain stable atmospheric pressure and prevent condensation
- Die-cast aluminum construction
- 120V direct wire—no driver needed
- 2" threaded heavy-duty mounting arm
- Photo or motion sensor sold separately



Ceiling Mounted
360° Horizontal rotation
90° Vertical aiming



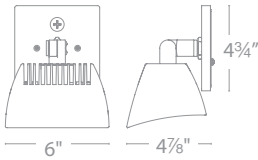

Shown with Round Canopy Box
Includes two canopies for use with surface mount or recessed junction boxes



Model	Color Temp	CRI	Power	Comparable	Max Lumens	Finish
WP-LED335 Flood	30	3000K	35.5W	100W HID	2450	aBK Architectural Black aBZ Architectural Bronze aGH Architectural Graphite aWT Architectural White
	50	5000K				
WP-LED354 Flood Pro	35	3500K	53W	150W HID	3445	

Example: **WP-LED354-35-aWT**

Model	Finish	Description	Features
 MS-120-BK MS-120-BZ MS-120-GY MS-120-WT	Black	Motion Sensor (120V)	<ul style="list-style-type: none"> • Detect motion to control on/off. • The double hinge structure allows users to aim the sensor in any position. • Can be mounted on a canopy or on a lighting fixture. • Built-in adjustable timer allows automatic shut off after the sensor coverage area is vacated. • Maximum time delay is 5 minutes, minimum is 5 seconds. • Designed for outdoor (wet location) or indoor application.
	Bronze		
	Gray		
	White		
 PC-120-BK PC-120-BZ PC-120-GY PC-120-WT	Black	Photosensor (120V)	<ul style="list-style-type: none"> • Detects the presence of visible light, infrared transmission (IR), and/or ultraviolet (UV) energy in order to control light on/off. • CEC Title 20 Compliant. • Intelligent light control of lighting fixtures based on ambient light. • The mechanical structure allows the user to lock the sensor in any position. • Can be mounted on a canopy or on a lighting fixture.
	Bronze		
	Gray		
	White		
 MP-120-BK MP-120-BZ MP-120-GY MP-120-WT	Black	Motion Sensor plus Photocell (120-277V)	<ul style="list-style-type: none"> • Detects motion to control fixtures on/off for adjustable amount of time (10 seconds to 10 minutes) • D2D mode allows sensor to be used as photocell • Motion sensitivity adjustable between 10ft to 50ft (180° cone) • Manual Override the sensor for 5hours by quickly flipping the light switch • Built-In learning function to prevent sensor from being affected by reflected light • Can be mounted on a canopy or on a lighting fixture
	Bronze		
	Gray		
	White		

ENDURANCE[®] SINGLE & DOUBLE SPOT



Input: 120V
Dimming: 100% - 10% ELV
Rated Life: 50,000 hours

- Factory-sealed LED light engine
- Die-cast aluminum construction
- 120V direct wire - no driver needed
- Photo/motion sensor sold separately



Model Color Temp CRI Power Comparable Max Lumens Finish

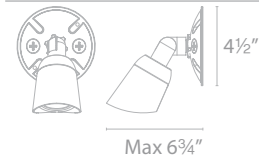

WP-LED415	30	3000K	85	15W	75W Halogen	965 1030	ABK	Architectural Black
	50	5000K					ABZ	Architectural Bronze
							AGH	Architectural Graphite
							AWT	Architectural White

ABK Architectural Black
ABZ Architectural Bronze
AGH Architectural Graphite
AWT Architectural White

Example: **WP-LED415-30-aWT**

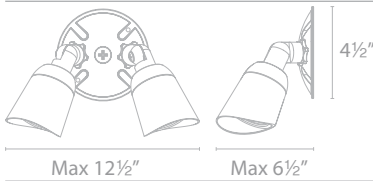

WP-LED430	30	3000K	85	30W	2 x 75W Halogen	965 x2 1030 x2	ABK	Architectural Black
	50	5000K					ABZ	Architectural Bronze
							AGH	Architectural Graphite
							AWT	Architectural White

ABK Architectural Black
ABZ Architectural Bronze
AGH Architectural Graphite
AWT Architectural White

Example: **WP-LED430-30-aBZ**

ENDURANCE LED WALL PACKS



Input: 120V-277V
Dimming: 100%-15% ELV
100%-30% 0-10V
Rated Life: 100,000 hours

- Factory-sealed LED light engine
- Die-cast aluminum construction
- 20° forward throw illumination
- Built-in level for easy adjustment
- Photo/Motion sensor sold separately



FIN

Tempered Prismatic Glass
Reduces glare while optimizing light distribution



HAWK

Mounts in any orientation for direct and indirect illumination



Includes box sleeve. For use with surface mount junction boxes

Model Color Temp CRI Power Comparable Max Lumen Finish

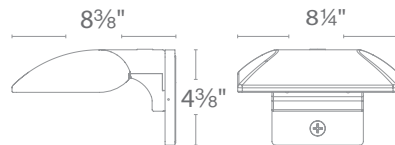

WP-LED219	30	3000K	85	19W	39W HID	1435	ABZ	Architectural Bronze
							AGH	Architectural Graphite
WP-LED227				27W	70W HID	2095	AWT	Architectural White

ABZ Architectural Bronze
AGH Architectural Graphite
AWT Architectural White

Example: **WP-LED219-30-aBZ**

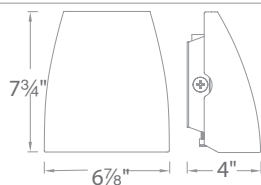

WP-LED119				19W	39W HID	1390	ABZ	Architectural Bronze
WP-LED127	30	3000K	85	27W	70W HID	2075	AGH	Architectural Graphite
WP-LED135				35W	100W HID	2750	AWT	Architectural White

ABZ Architectural Bronze
AGH Architectural Graphite
AWT Architectural White

Example: **WP-LED119-30-aGH**

ENDURANCE[®]

ADJUSTABLE WALL-MOUNTED LED SPOTLIGHT



Input: 120V
 Dimming: 100% - 10% ELV
 Rated Life: 50,000 hours

Designed for sign lighting or wall mounted lighting in any direction

- Factory-sealed LED light engine
- Die-cast aluminum construction
- 120V direct wire - no driver needed

360° Rotation on axis

Rotate to continuously adjust beam angles indexed at 15° to 60°

Safety cable recommended for extensions over 36"



	Model	Color Temp	CRI	Power	Comparable	Max Lumens	Finish
	WP-LED514 Single	30 40	3000K 4000K	85	15W PAR 38	1140	aBK Architectural Black aBZ Architectural Bronze aGH Architectural Graphite aWT Architectural White
	WP-LED529 Double	30 40	3000K 4000K	85	30W 150W x2 PAR 38	1140 x2	ABK Architectural Black ABZ Architectural Bronze AGH Architectural Graphite AWT Architectural White

Example: WP-LED529-30-aWT



Includes extension rod kit to extend up to 48"



Safety cable and canopy included

Includes extension rod kit to extend up to 48"



WP-LED514
Single

Rotate 180°

Extendable rod

PHOTOMETRICS			
Beam Setting	Power - 15W Per Head		
	Distance	Foot Candles	Beam Diameter
15°	2'	1036 fc	½'
	3'	460 fc	1'
	4'	259 fc	1'
25°	2'	600 fc	1'
	3'	267 fc	1½'
	4'	150 fc	2'
40°	2'	378 fc	1½'
	3'	168 fc	2'
	4'	95 fc	3'
60°	2'	219 fc	2½'
	3'	93 fc	3½'
	4'	54 fc	4½'

RUBIX

LED CEILING MOUNTS



Input: 120-277V
 Dimming: 100% - 10% ELV or 0-10V
 Rated Life: 70,000 hours

- Ceiling mount
- Die-cast aluminum construction



FM-W2505



FM-W2510

	Model	Color Temp	CRI	Power	Beam Angle	Max Lumens	Finish
	FM-W2505	3000K	90	16W	86°	750	AL Brushed Aluminum BK Black BZ Bronze GH Graphite WT White
	FM-W2510	3000K	90	30W	95°	1875	AL Brushed Aluminum BK Black BZ Bronze GH Graphite WT White

Example: **FM-W2505-WT**

TUBE LED PENDANT



Input: 120-277V
 Dimming: 100%-10% ELV 100%-5% 0-10V
 Rated Life: 70,000 hours

- Die-cast aluminum construction
- Hang straight swivel
- Three 12" and one 6" down rods included



PD-W2605

	Model	Color Temp	CRI	Power	Beam Angle	Max Lumens	Finish
	PD-W2605	3000K	90	16W	33°	800	AL Brushed Aluminum
							BK Black
							BZ Bronze
							GH Graphite
							WT White

Example: PD-W2605-BK

TUBE CEILING MOUNT



Input: 120-277V
 Dimming: 100%-10% ELV 100%-5% 0-10V
 Rated Life: 70,000 hours

- Ceiling mount
- Die-cast aluminum construction



FM-W2605



FM-W2612

	Model	Color Temp	CRI	Power	Beam Angle	Max Lumens	Finish
	FM-W2605	3000K	90	16W	35°	800	AL Brushed Aluminum
							BK Black
							BZ Bronze
							GH Graphite
							WT White
	FM-W2612	3000K	90	30W	91°	1740	AL Brushed Aluminum
							BK Black
							BZ Bronze
							GH Graphite
							WT White

Example: FM-W2605-WT

RUBIX

LED WALL MOUNTS



- Mounts up or down
- Die-cast aluminum construction

Input: 120-277V
 Dimming: 100%-10% ELV 100%-5% 0-10V
 Rated Life: 70,000 hours



Model	Color Temp	CRI	Power	Beam Angle	Max Lumens	Finish
 WS-W2509 Single Light	3000K	90	16W	86°	805	AL Brushed Aluminum
						BK Black
						BZ Bronze
						GH Graphite
						WT White

Example: **WS-W2509-WT**



- Mounts up or down
- Die-cast aluminum construction

Input: 120-277V
 Dimming: 100%-10% ELV 100%-5% 0-10V
 Rated Life: 70,000 hours



Model	Color Temp	CRI	Power	Beam Angle	Max Lumens	Finish
 WS-W2510 Up & Down Light	3000K	90	30W	86°	1385	AL Brushed Aluminum
						BK Black
						BZ Bronze
						GH Graphite
						WT White

Example: **WS-W2510-GH**



- Mounts up or down
- Die-cast aluminum construction



Input: 120-277V
 Dimming: 100%-10% ELV 100%-5% 0-10V
 Rated Life: 70,000 hours



WS-W2504

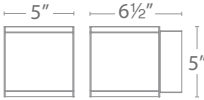

WS-W2505

 WS-W2504 Single Light	3000K	90	16W	86°	750	AL Brushed Aluminum
						BK Black
						BZ Bronze
						GH Graphite
						WT White
 WS-W2505 Up & Down Light	3000K	90	30W	86°	1400	AL Brushed Aluminum
						BK Black
						BZ Bronze
						GH Graphite
						WT White

Example: **WS-W2504-BZ**

TUBE LED WALL MOUNT



Input: 120-277V
 Dimming: 100%-10% ELV 100%-5% 0-10V
 Rated Life: 70,000 hours

- Die-cast aluminum construction
- Single light mounts up or down



WS-W2605



WS-W2604



	Model	Color Temp	CRI	Power	Beam Angle	Max Lumens	Finish
	WS-W2605 Single Light	3000K	90	16W	33°	800	AL Brushed Aluminum BK Black BZ Bronze GH Graphite WT White
	WS-W2604 Up & Down Light	3000K	90	30W	33°	1750	AL Brushed Aluminum BK Black BZ Bronze GH Graphite WT White

Example: **WS-W2605-AL**

TUBE LED WALL MOUNT



Input: 120-277V
 Dimming: 100%-10% ELV 100%-5% 0-10V
 Rated Life: 70,000 hours

- Die-cast aluminum construction
- Single light mounts up or down



WS-W2609



WS-W2610



	Model	Color Temp	CRI	Power	Beam Angle	Max Lumens	Finish
	WS-W2609 Single Light	3000K	90	16W	70°	825	AL Brushed Aluminum BK Black BZ Bronze GH Graphite WT White
	WS-W2610 Up & Down Light	3000K	90	30W	70°	1525	AL Brushed Aluminum BK Black BZ Bronze GH Graphite WT White

Example: **WS-W2609-BK**



12V MAGNETIC TRANSFORMER

Input: 120V
Output: 12VAC
Rated Life: 50,000 hours

- Features a built-in on/off photocell with a timer that adjusts to sunset and sunrise
- Two channels support separate lighting runs
- Includes a 6-foot cord and plug for power
- Constructed of stainless steel

Magnetic Transformer	Model	Wattage	Finish
	LC-2531100	100W	SS Stainless Steel
	LC-2531200	200W	

Example: **LC-2531100-SS**



ALL-IN-ONE CCT SELECTABLE



SPOTT

Input: 9-15VAC
 Rated Life: 50,000 hours

- The mounting stake includes a foot push bar for easy installation
- It is designed with a shroud to help reduce glare
- A 5CCT switch is hidden under the back cap for a clean aesthetic
- A side-mounted knob allows for tool-less tilt adjustment
- Constructed of aluminum with a glass lens

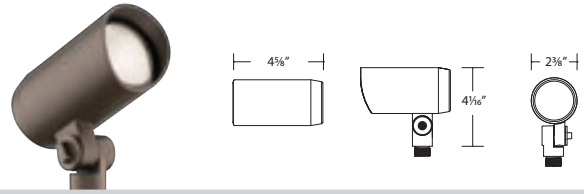

Model	Beam	Max Lumens	Wattage	Color Temp	Finish
LC-253205	F 30°	560	7W	2700K	CS BZ Bronze
		3000K			
	W 60°	535		3500K	
		4000K			
		5000K			

Example: LC-253205-FCS-BZ

LANTERN, STAFF, CONE

Input: 9-15VAC
 Rated Life: 50,000 hours

- The mounting stake includes a foot push bar for easy installation
- Comes with two separate 10" rods to allow for height adjustment
- A 5CCT switch is hidden for a clean aesthetic
- Constructed of aluminum with a polycarbonate lens

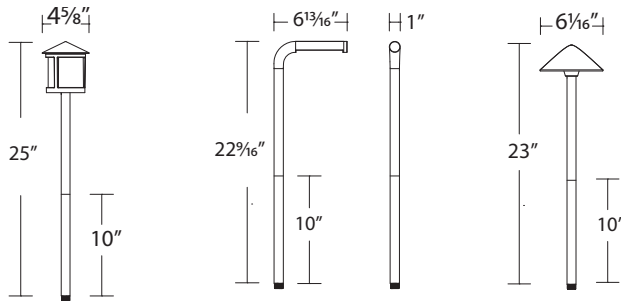

Model	Max Lumens	Wattage	Color Temp	Finish
LC-253305	155	3W	2700K	CS BZ Bronze
LC-253401	225	4W	3000K	
LC-253507	150	4W	3500K	
			4000K	
			5000K	

Example: LC-253305-CS-BZ

CIRKEL & PLAYNE

Input: 9-15VAC
 Rated Life: 50,000 hours

- The clip-in mounting system features an integrated wire slot for streamlined installation
- A 5CCT switch is hidden on the back for a clean aesthetic
- Constructed of aluminum with an acrylic lens

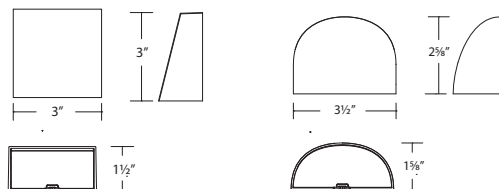

Model	Max Lumens	Wattage	Color Temp	Finish
LC-253603	140	3W	2700K	CS BZ Bronze
LC-253703	115		3000K	
			3500K	
			4000K	
			5000K	

Example: LC-253603-CS-BZ



TRANSFORMER LANDSCAPE

A rugged, outdoor-rated stainless steel transformer designed for reliable landscape lighting performance. Multiple voltage taps support long runs and consistent output, with integrated knockouts for power and photocell connections.





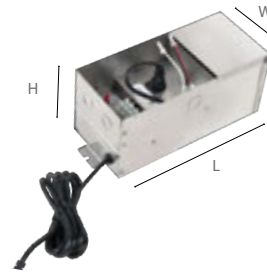

- 12V to 15V taps
- Knockouts for power and photo sensor connections
- 3-prong outlet for timer
- Outdoor Rated stainless steel transformer contains an outdoor Rated 3-prong plug for power

Model	
9075-TRN-SS	75W Max Dimensions: 13.97" L x 5.35"W x 5.63"H
9150-TRN-SS	150W Max Dimensions: 18.90" L x 6.69"W x 6.30"H
9300-TRN-SS	300W Max Dimensions: 18.90" L x 6.69"W x 6.30"H
9600-TRN-SS	600W Max (2 x 300W outputs) Dimensions: 14.49" L x 10.08"W x 5.94"H







ACCESSORIES LANDSCAPE

Accessories LED LANDSCAPE

External Low Voltage MLV Dimmer		9000-MLV-BK	Black on Aluminum	Max Load: 150W at 12VAC Minimum load: None Capacity: 13A Input Voltage: 12-15VAC
Mechanical Timer		9000-MTI-WT	White	Connect within the transformer
Photosensor		9000-PCH-GY	1000VA Max	Attached directly to the transformer
Photosensor - Remote		9000-PCR-GY	1000VA Max	If transformer is located in a shady spot, this photosensor has a 10 foot cord and a stainless steel bracket to secure in a sunny area
Direct Burial Water proof Wire Nuts		9020-WNT-BK		Silicone filled wire nut with gasket (Pack of 20pcs)
12V Direct Burial Outdoor Cable		9100-12G-BK 9250-12G-BK 9500-12G-BK	100 feet 12 gauge 250 feet 12 gauge 500 feet 12 gauge	





Accessories 3" INGROUND

Non-slip lens		5030-NSLEN-CL	Clear/patterned	Slip resistant lens
Rock Guard		5030-GRD-BZ 5030-GRD-BBR	Bronze on Aluminum Bronze on Brass	Protects the fixture surface
Anti-Glare Shroud		5030-SHR-BZ 5030-SHR-BBR	Bronze on Aluminum Bronze on Brass	Reduces glare
Concrete Pour Kit		5030-PIP-PVC	Shown with temporary dense foam cap	For installation in concrete; five 1/2" NPT threaded holes, PC

Accessories GRAND INGROUND















Rock Guard		5830-GRD-BZ 5830-GRD-BBR	Bronze on Aluminum Bronze on Brass	Protects the fixture surface
Anti-Glare Shroud		5033-SHR-BZ 5033-SHR-BBR	Bronze on Aluminum Bronze on Brass	Reduces glare
Concrete Pour Kit		5830-PIP-PVC	Shown with temporary dense foam cap	For installation in concrete; five 1/2" NPT threaded holes, PVC

Accessories RECESSED + INGROUND

		2000-CON-PVC 2" Concrete Pour Kit	For installation in concrete. 18" PVC pipe included. Installs onto a 4" outdoor rated junction box.
		1000-CON-PVC 1" Concrete Pour Kit	For installation in concrete. 18" PVC pipe included. Installs onto a 4" outdoor rated junction box.

ACCESSORIES **LANDSCAPE**

Accessories MOUNTING & GLARE CONTROL

5" Long Shroud For 5211/5212 Grand Accent		5211-LSHR-BK 5211-LSHR-BZ 5211-LSHR-BBR	Reduce glare; ideal for downlighting application
6" Long Shroud For 5011/5012 Accent		5010-LSHR-BK 5010-LSHR-BZ 5010-LSHR-BBR	Reduce glare; ideal for downlighting application
5" Long Shroud For 5111 Mini Accent		5111-LSHR-BK 5111-LSHR-BZ 5111-LSHR-BBR	Reduce glare; ideal for downlighting application
Grand Accent Snoot		5211-SNOOT-BK 5211-SNOOT-BZ 5211-SNOOT-BBR	Reduce glare; ideal for downlighting application
Accent Snoot		5010-SNOOT-BK 5010-SNOOT-BZ 5010-SNOOT-BBR	Reduce glare; ideal for downlighting application
Mini Accent Snoot		5111-SNOOT-BK 5111-SNOOT-BZ 5111-SNOOT-BBR	Reduce glare; ideal for downlighting application
9" Mounting Stake		9000-ST9-BZ	Durable PC stake
14" Mounting Stake		9000-ST14-BZ	Durable PC stake
Surface Mount Flange/Stake		5000-SCP-BK 5000-SCP-BZ 5000-SCP-BBR	Includes three 7 inch threaded stainless steel stabilizing pins for ground mounting or surface mounts with four screws or over a junction box
Guardian Mount		9000-SP9-BZ	Heavy duty stainless steel spike to position fixture
Gutter Mount Bracket		5000-GM-BK 5000-GM-BZ 5000-GM-WT	Stainless steel universal mounting bracket for gutter mounting fixture
Tree Mount Junction Box		5000-TCP-BK 5000-TCP-BZ	Aluminum box with stainless steel mounting screws; two 1/2" NPT threaded holes, UL 120V listed
		5000-TCL-BK 5000-TCL-BZ	Large aluminum box with stainless steel mounting screws; two 1/2" NPT threaded holes, UL 120V listed
Large Tree Mount Canopy Strap		5000-TST-BK	Ratcheting device with strap to be used with Large Tree Mount Junction Box (5000-TCL)
		5000-STB-BK	Tree mount bracket only
Power Stake		M6000-STAKE	Power Stake for both 12V and 120V fixtures

Accessories OPTIC

Grand Accent Optics		LENS-25-AMB LENS-25-GRN LENS-25-RED	Amber Green Red	LENS-25-BLU LENS-25-FR LENS-25-SPR	Blue Frosted Spread	5211-HCL LENS-25-BEL	Honeycomb Louver Elongating Beam
Accent Optics		LENS-20-AMB LENS-20-GRN LENS-20-RED	Amber Green Red	LENS-20-BLU LENS-20-FR LENS-20-SPR	Blue Frosted Spread	5011-HCL LENS-20-BEL	Honeycomb Louver Elongating Beam
Mini Accent Optics		LENS-16-AMB LENS-16-GRN LENS-16-RED	Amber Green Red	LENS-16-BLU LENS-16-FR LENS-16-SPR	Blue Frosted Spread	5111-HCL LENS-16-BEL	Honeycomb Louver Elongating Beam
Mini Wall Wash Optics		LENS-2X3-AMB LENS-2X3-GRN LENS-2X3-RED	Amber Green Red	LENS-2X3-BLU LENS-2X3-FR LENS-2X3-SPR	Blue Frosted Spread	LENS-2X3-BEL	Elongating Beam
Wall Wash Optics		LENS-2X4-AMB LENS-2X4-GRN LENS-2X4-RED	Amber Green Red	LENS-2X4-BLU LENS-2X4-FR LENS-2X4-SPR	Blue Frosted Spread		
NEMA Wall Wash Optics		LENS-3X5-AMB LENS-3X5-GRN LENS-3X5-RED	Amber Green Red	LENS-3X5-BLU LENS-3X5-FR LENS-3X5-SPR	Blue Frosted Spread	LENS-3X5-BEL	Elongating Beam

ACCESSORIES LANDSCAPE

Accessories LANDSCAPE TAPE LIGHTING

	InvisiLED® Outdoor Joiner Cable Extends power supply lead wire	T24-WE-IC-002-BK 2 in T24-WE-IC-006-BK 6 in T24-WE-IC-012-BK 1 ft T24-WE-IC-036-BK 3 ft T24-WE-IC-072-BK 6 ft T24-WE-IC-144-BK 12 ft T24-WE-IC-240-BK 20ft	Black		InvisiLED® Outdoor Surface Mounting Clip	LED-TO24-C1	Black (10 pieces)
	InvisiLED® Outdoor Lead Wire Connects to Indoor Power Supply	T24-WE-BO12-BK 1 ft T24-WE-BO72-BK 6 ft	Black		InvisiLED® Outdoor Edge Mounting Clip	LED-TO24-C2	Black (10 pieces)
	InvisiLED® Outdoor Power Connector Kit with Wire Jacket and Silicone Sealant Allows power to Wet Rated tape	T24-WE-EX2-006-BK 6 in	Black		InvisiLED® Outdoor Underside Mounting Clip	T24-WE-C3	Black (10 pieces)
	InvisiLED® Outdoor Tape to Tape Y Connector Splits power to the two tape sections	T24-WE-Y-BK	Black		InvisiLED® Outdoor Surface Mount Clear Channel	T24-WE-CH5	5 ft Clear
	Wet Rated Tape End Cap with Silicone Sealant. 24VDC Wet Rated (10 pieces)	T24-WE-EC	Clear		Silicone Sealant Tape Sealant (45 grams)	T24-WE-SI-45	White
	5' Clear Channel	T24-OD-CH5-CL	5 ft	Includes mounting hardware	Clear		
	L & J Connector	T24-OD-L-WT		90 Degree Angle Connection	White		
	Invisible Clip	T24-OD-C3-WT		Spring clip secures beneath tape (10pcs/Pack)	White		
	Surface Mounting Clip	T24-OD-C1-WT		For installation on non-flat surfaces where there is no edge contact (10pcs/pack)	White		
	Edge Mounting Clip	T24-OD-C2-WT		For installation on non-flat surfaces, allows for contact on one edge (10 pcs/pack)	White		
	End Cap	T24-OD-EC-WT		Seal cut end with silicone after adding end cap	White		
	Joiner Cable	T24-OD-IC6-WT 6 in T24-OD-IC12-WT 1 ft T24-OD-IC72-WT 6 ft T24-OD-IC120-WT 10 ft		Connects between tape sections, Extends power supply lead wire	White		
	4 Way "X" Connector	T24-OD-X-WT		4 - Way extension (1 Male end, 3 Female)	White		
	3 Way "Y" Connector	T24-OD-Y-WT		3 - Way extension (1 Male, 2 Female)	White		
	Lead Wire w/ 5A fuse	8002-06WT 6 ft 8002-10WT 10 ft		Lead wire to connect 12V Landscape tape with Landscape Magnetic Transformer	White		
	InvisiLED® Outdoor Joiner Cable	T24-WE-EX-CTR	6 in	Joiner cable between wireless controller to InvisiLED® Outdoor Tape	White		
	DMX Signal Cable - Universe	T24-OD-MW60 5 ft T24-OD-MW120 10 ft		DMX to Universe controller	Black		
	DMX Signal Cable - Satellite	T24-OD-SW60 5 ft T24-OD-SW120 10 ft		Master to Satellite controller or Satellite to Satellite	Black		

GRAND ACCENT 12V PHOTOMETRICS

At 15° Setting



POWER	15W		22W		26W		30W		33W	
DISTANCE	FOOT CANDLES	BEAM WIDTH	FOOT CANDLES	BEAM WIDTH	FOOT CANDLES	BEAM WIDTH	FOOT CANDLES	BEAM WIDTH	FOOT CANDLES	BEAM WIDTH
4ft	260.4fc	1.1ft	418.4fc	1.1ft	465.4fc	1.1ft	521.4fc	1.1ft	549.3fc	1.1ft
8ft	65.1fc	2.1ft	104.6fc	2.1ft	116.4fc	2.1ft	130.4fc	2.1ft	137.3fc	2.1ft
12ft	28.9fc	3.2ft	46.5fc	3.2ft	51.7fc	3.2ft	57.9fc	3.2ft	61.0fc	3.2ft
16ft	16.3fc	4.2ft	26.2fc	4.2ft	29.1fc	4.2ft	32.6fc	4.2ft	34.3fc	4.2ft
24ft	7.2fc	6.3ft	11.6fc	6.3ft	12.9fc	6.3ft	14.5fc	6.3ft	15.3fc	6.3ft
32ft	4.1fc	8.4ft	6.5fc	8.4ft	7.3fc	8.4ft	8.1fc	8.4ft	8.6fc	8.4ft
40ft	2.6fc	10.5ft	4.2fc	10.5ft	4.7fc	10.5ft	5.2fc	10.5ft	5.5fc	10.5ft
48ft	1.8fc	12.6ft	2.9fc	12.6ft	3.2fc	12.6ft	3.6fc	12.6ft	3.8fc	12.6ft
60ft	1.2fc	15.8ft	1.9fc	15.8ft	2.1fc	15.8ft	2.3fc	15.8ft	2.4fc	15.8ft

At 25° Setting



POWER	15W		22W		26W		30W		33W	
DISTANCE	FOOT CANDLES	BEAM WIDTH	FOOT CANDLES	BEAM WIDTH	FOOT CANDLES	BEAM WIDTH	FOOT CANDLES	BEAM WIDTH	FOOT CANDLES	BEAM WIDTH
4ft	198.0fc	1.8ft	323.3fc	1.8ft	362.6fc	1.8ft	399.3fc	1.8ft	418.4fc	1.8ft
8ft	49.5fc	3.5ft	80.8fc	3.5ft	90.7fc	3.5ft	99.8fc	3.5ft	104.6fc	3.5ft
12ft	22.0fc	5.3ft	35.9fc	5.3ft	40.3fc	5.3ft	44.4fc	5.3ft	46.5fc	5.3ft
16ft	12.4fc	7.1ft	20.2fc	7.1ft	22.7fc	7.1ft	25.0fc	7.1ft	26.2fc	7.1ft
24ft	5.5fc	10.6ft	9.0fc	10.6ft	10.1fc	10.6ft	11.1fc	10.6ft	11.6fc	10.6ft
32ft	3.1fc	14.2ft	5.1fc	14.2ft	5.7fc	14.2ft	6.2fc	14.2ft	6.5fc	14.2ft
40ft	2.0fc	17.7ft	3.2fc	17.7ft	3.6fc	17.7ft	4.0fc	17.7ft	4.2fc	17.7ft
48ft	1.4fc	21.3ft	2.2fc	21.3ft	2.5fc	21.3ft	2.8fc	21.3ft	2.9fc	21.3ft
60ft	0.9fc	26.6ft	1.4fc	26.6ft	1.6fc	26.6ft	1.8fc	26.6ft	1.9fc	26.6ft

At 40° Setting



POWER	15W		22W		26W		30W		33W	
DISTANCE	FOOT CANDLES	BEAM WIDTH	FOOT CANDLES	BEAM WIDTH	FOOT CANDLES	BEAM WIDTH	FOOT CANDLES	BEAM WIDTH	FOOT CANDLES	BEAM WIDTH
4ft	107.4fc	2.9ft	167.4fc	2.9ft	191.5fc	2.9ft	210.8fc	2.9ft	223.2fc	2.9ft
8ft	26.8fc	5.8ft	41.9fc	5.8ft	47.9fc	5.8ft	52.7fc	5.8ft	55.8fc	5.8ft
12ft	11.9fc	8.7ft	18.6fc	8.7ft	21.3fc	8.7ft	23.4fc	8.7ft	24.8fc	8.7ft
16ft	6.7fc	11.6ft	10.5fc	11.6ft	12.0fc	11.6ft	13.2fc	11.6ft	13.9fc	11.6ft
24ft	3.0fc	17.5ft	4.7fc	17.5ft	5.3fc	17.5ft	5.9fc	17.5ft	6.2fc	17.5ft
32ft	1.7fc	23.3ft	2.6fc	23.3ft	3.0fc	23.3ft	3.3fc	23.3ft	3.5fc	23.3ft
40ft	1.1fc	29.1ft	1.7fc	29.1ft	1.9fc	29.1ft	2.1fc	29.1ft	2.2fc	29.1ft
48ft	0.7fc	34.9ft	1.2fc	34.9ft	1.3fc	34.9ft	1.5fc	34.9ft	1.5fc	34.9ft
60ft	0.5fc	43.7ft	0.7fc	43.7ft	0.9fc	43.7ft	0.9fc	43.7ft	1.0fc	43.7ft

At 60° Setting



POWER	15W		22W		26W		30W		33W	
DISTANCE	FOOT CANDLES	BEAM WIDTH	FOOT CANDLES	BEAM WIDTH	FOOT CANDLES	BEAM WIDTH	FOOT CANDLES	BEAM WIDTH	FOOT CANDLES	BEAM WIDTH
4ft	50.1fc	4.6ft	79.4fc	4.6ft	91.6fc	4.6ft	100.1fc	4.6ft	105.4fc	4.6ft
8ft	12.5fc	9.2ft	19.8fc	9.2ft	22.9fc	9.2ft	25.0fc	9.2ft	26.3fc	9.2ft
12ft	5.6fc	13.9ft	8.8fc	13.9ft	10.2fc	13.9ft	11.1fc	13.9ft	11.7fc	13.9ft
16ft	3.1fc	18.5ft	5.0fc	18.5ft	5.7fc	18.5ft	6.3fc	18.5ft	6.6fc	18.5ft
24ft	1.4fc	27.7ft	2.2fc	27.7ft	2.5fc	27.7ft	2.8fc	27.7ft	2.9fc	27.7ft
32ft	0.8fc	37.0ft	1.2fc	37.0ft	1.4fc	37.0ft	1.6fc	37.0ft	1.6fc	37.0ft
40ft	0.5fc	46.2ft	0.8fc	46.2ft	0.9fc	46.2ft	1.0fc	46.2ft	1.1fc	46.2ft
48ft	0.3fc	55.4ft	0.6fc	55.4ft	0.6fc	55.4ft	0.7fc	55.4ft	0.7fc	55.4ft
60ft	0.2fc	69.3ft	0.4fc	69.3ft	0.4fc	69.3ft	0.4fc	69.3ft	0.5fc	69.3ft

GRAND ACCENT 120V PHOTOMETRICS

At 15° Setting	POWER	13W		16W		21W		26W		31W	
	DISTANCE	FOOT CANDLES	BEAM WIDTH	FOOT CANDLES	BEAM WIDTH	FOOT CANDLES	BEAM WIDTH	FOOT CANDLES	BEAM WIDTH	FOOT CANDLES	BEAM WIDTH
	4ft	298.8fc	1.1ft	356.4fc	1.1ft	457.7fc	1.1ft	541.1fc	1.1ft	613.5fc	1.1ft
	8ft	74.7fc	2.1ft	89.1fc	2.1ft	114.4fc	2.1ft	135.3fc	2.1ft	153.4fc	2.1ft
	12ft	33.2fc	3.2ft	39.6fc	3.2ft	50.9fc	3.2ft	60.1fc	3.2ft	68.2fc	3.2ft
	16ft	18.7fc	4.2ft	22.3fc	4.2ft	28.6fc	4.2ft	33.8fc	4.2ft	38.3fc	4.2ft
	24ft	8.3fc	6.3ft	9.9fc	6.3ft	12.7fc	6.3ft	15.0fc	6.3ft	17.0fc	6.3ft
	32ft	4.7fc	8.4ft	5.6fc	8.4ft	7.2fc	8.4ft	8.5fc	8.4ft	9.6fc	8.4ft
	40ft	3.0fc	10.5ft	3.6fc	10.5ft	4.6fc	10.5ft	5.4fc	10.5ft	6.1fc	10.5ft
	48ft	2.1fc	12.6ft	2.5fc	12.6ft	3.2fc	12.6ft	3.8fc	12.6ft	4.3fc	12.6ft
	60ft	1.3fc	15.8ft	1.6fc	15.8ft	2.0fc	15.8ft	2.4fc	15.8ft	2.7fc	15.8ft

At 25° Setting	POWER	13W		16W		21W		26W		31W	
	DISTANCE	FOOT CANDLES	BEAM WIDTH	FOOT CANDLES	BEAM WIDTH	FOOT CANDLES	BEAM WIDTH	FOOT CANDLES	BEAM WIDTH	FOOT CANDLES	BEAM WIDTH
	4ft	238.8fc	1.8ft	281.6fc	1.8ft	356.1fc	1.8ft	424.5fc	1.8ft	474.8fc	1.8ft
	8ft	59.7fc	3.5ft	70.4fc	3.5ft	89.0fc	3.5ft	106.1fc	3.5ft	118.7fc	3.5ft
	12ft	26.5fc	5.3ft	31.3fc	5.3ft	39.6fc	5.3ft	47.2fc	5.3ft	52.8fc	5.3ft
	16ft	14.9fc	7.1ft	17.6fc	7.1ft	22.3fc	7.1ft	26.5fc	7.1ft	29.7fc	7.1ft
	24ft	6.6fc	10.6ft	7.8fc	10.6ft	9.9fc	10.6ft	11.8fc	10.6ft	13.2fc	10.6ft
	32ft	3.7fc	14.2ft	4.4fc	14.2ft	5.6fc	14.2ft	6.6fc	14.2ft	7.4fc	14.2ft
	40ft	2.4fc	17.7ft	2.8fc	17.7ft	3.6fc	17.7ft	4.2fc	17.7ft	4.7fc	17.7ft
	48ft	1.7fc	21.3ft	2.0fc	21.3ft	2.5fc	21.3ft	2.9fc	21.3ft	3.3fc	21.3ft
	60ft	1.1fc	26.6ft	1.3fc	26.6ft	1.6fc	26.6ft	1.9fc	26.6ft	2.1fc	26.6ft

At 40° Setting	POWER	13W		16W		21W		26W		31W	
	DISTANCE	FOOT CANDLES	BEAM WIDTH	FOOT CANDLES	BEAM WIDTH	FOOT CANDLES	BEAM WIDTH	FOOT CANDLES	BEAM WIDTH	FOOT CANDLES	BEAM WIDTH
	4ft	113.6fc	2.9ft	136.1fc	2.9ft	175.2fc	2.9ft	204.2fc	2.9ft	234.2fc	2.9ft
	8ft	28.4fc	5.8ft	34.0fc	5.8ft	43.8fc	5.8ft	51.0fc	5.8ft	58.5fc	5.8ft
	12ft	12.6fc	8.7ft	15.1fc	8.7ft	19.5fc	8.7ft	22.7fc	8.7ft	26.0fc	8.7ft
	16ft	7.1fc	11.6ft	8.5fc	11.6ft	10.9fc	11.6ft	12.8fc	11.6ft	14.6fc	11.6ft
	24ft	3.2fc	17.5ft	3.8fc	17.5ft	4.9fc	17.5ft	5.7fc	17.5ft	6.5fc	17.5ft
	32ft	1.8fc	23.3ft	2.1fc	23.3ft	2.7fc	23.3ft	3.2fc	23.3ft	3.7fc	23.3ft
	40ft	1.1fc	29.1ft	1.4fc	29.1ft	1.8fc	29.1ft	2.0fc	29.1ft	2.3fc	29.1ft
	48ft	0.8fc	34.9ft	0.9fc	34.9ft	1.2fc	34.9ft	1.4fc	34.9ft	1.6fc	34.9ft
	60ft	0.5fc	43.7ft	0.6fc	43.7ft	0.8fc	43.7ft	0.9fc	43.7ft	1.0fc	43.7ft

At 60° Setting	POWER	13W		16W		21W		26W		31W	
	DISTANCE	FOOT CANDLES	BEAM WIDTH	FOOT CANDLES	BEAM WIDTH	FOOT CANDLES	BEAM WIDTH	FOOT CANDLES	BEAM WIDTH	FOOT CANDLES	BEAM WIDTH
	4ft	53.5fc	4.6ft	64.2fc	4.6ft	81.9fc	4.6ft	97.1fc	4.6ft	110.1fc	4.6ft
	8ft	13.4fc	9.2ft	16.0fc	9.2ft	20.5fc	9.2ft	24.3fc	9.2ft	27.5fc	9.2ft
	12ft	5.9fc	13.9ft	7.1fc	13.9ft	9.1fc	13.9ft	10.8fc	13.9ft	12.2fc	13.9ft
	16ft	3.3fc	18.5ft	4.0fc	18.5ft	5.1fc	18.5ft	6.1fc	18.5ft	6.9fc	18.5ft
	24ft	1.5fc	27.7ft	1.8fc	27.7ft	2.3fc	27.7ft	2.7fc	27.7ft	3.1fc	27.7ft
	32ft	0.8fc	37.0ft	1.0fc	37.0ft	1.3fc	37.0ft	1.5fc	37.0ft	1.7fc	37.0ft
	40ft	0.5fc	46.2ft	0.6fc	46.2ft	0.8fc	46.2ft	1.0fc	46.2ft	1.1fc	46.2ft
	48ft	0.4fc	55.4ft	0.4fc	55.4ft	0.6fc	55.4ft	0.7fc	55.4ft	0.8fc	55.4ft
	60ft	0.2fc	69.3ft	0.3fc	69.3ft	0.4fc	69.3ft	0.4fc	69.3ft	0.5fc	69.3ft

ACCENT 12V PHOTOMETRICS

At 10° Setting



POWER	1W		2W		8W		15W		18W	
DISTANCE	FOOT CANDLES	BEAM WIDTH	FOOT CANDLES	BEAM WIDTH	FOOT CANDLES	BEAM WIDTH	FOOT CANDLES	BEAM WIDTH	FOOT CANDLES	BEAM WIDTH
4ft	55.9fc	0.8ft	129.0fc	0.8ft	233.8fc	0.8ft	341.4fc	0.8ft	435.3fc	0.8ft
8ft	14.0fc	1.7ft	32.3fc	1.7ft	58.5fc	1.7ft	85.4fc	1.7ft	108.8fc	1.7ft
12ft	6.2fc	2.5ft	14.3fc	2.5ft	26.0fc	2.5ft	37.9fc	2.5ft	48.4fc	2.5ft
16ft	3.5fc	3.4ft	8.1fc	3.4ft	14.6fc	3.4ft	21.3fc	3.4ft	27.2fc	3.4ft
24ft	1.6fc	5.0ft	3.6fc	5.0ft	6.5fc	5.0ft	9.5fc	5.0ft	12.1fc	5.0ft
32ft	0.9fc	6.7ft	2.0fc	6.7ft	3.7fc	6.7ft	5.3fc	6.7ft	6.8fc	6.7ft
40ft	0.6fc	8.4ft	1.3fc	8.4ft	2.3fc	8.4ft	3.4fc	8.4ft	4.4fc	8.4ft
48ft	0.4fc	10.1ft	0.9fc	10.1ft	1.6fc	10.1ft	2.4fc	10.1ft	3.0fc	10.1ft
60ft	0.2fc	12.6ft	0.6fc	12.6ft	1.0fc	12.6ft	1.5fc	12.6ft	1.9fc	12.6ft

At 25° Setting



POWER	1W		2W		8W		15W		18W	
DISTANCE	FOOT CANDLES	BEAM WIDTH	FOOT CANDLES	BEAM WIDTH	FOOT CANDLES	BEAM WIDTH	FOOT CANDLES	BEAM WIDTH	FOOT CANDLES	BEAM WIDTH
4ft	25.2fc	1.8ft	54.8fc	1.8ft	105.8fc	1.8ft	153.0fc	1.8ft	194.6fc	1.8ft
8ft	6.3fc	3.5ft	13.7fc	3.5ft	26.5fc	3.5ft	38.3fc	3.5ft	48.7fc	3.5ft
12ft	2.8fc	5.3ft	6.1fc	5.3ft	11.8fc	5.3ft	17.0fc	5.3ft	21.6fc	5.3ft
16ft	1.6fc	7.1ft	3.4fc	7.1ft	6.6fc	7.1ft	9.6fc	7.1ft	12.2fc	7.1ft
24ft	0.7fc	10.6ft	1.5fc	10.6ft	2.9fc	10.6ft	4.3fc	10.6ft	5.4fc	10.6ft
32ft	0.4fc	14.2ft	0.9fc	14.2ft	1.7fc	14.2ft	2.4fc	14.2ft	3.0fc	14.2ft
40ft	0.3fc	17.7ft	0.5fc	17.7ft	1.1fc	17.7ft	1.5fc	17.7ft	1.9fc	17.7ft
48ft	0.2fc	21.3ft	0.4fc	21.3ft	0.7fc	21.3ft	1.1fc	21.3ft	1.4fc	21.3ft
60ft	0.1fc	26.6ft	0.2fc	26.6ft	0.5fc	26.6ft	0.7fc	26.6ft	0.9fc	26.6ft

At 40° Setting



POWER	1W		2W		8W		15W		18W	
DISTANCE	FOOT CANDLES	BEAM WIDTH	FOOT CANDLES	BEAM WIDTH	FOOT CANDLES	BEAM WIDTH	FOOT CANDLES	BEAM WIDTH	FOOT CANDLES	BEAM WIDTH
4ft	14.5fc	3.0ft	33.2fc	3.0ft	60.2fc	3.0ft	88.6fc	3.0ft	113.9fc	3.0ft
8ft	3.6fc	6.1ft	8.3fc	6.1ft	15.0fc	6.1ft	22.1fc	6.1ft	28.5fc	6.1ft
12ft	1.6fc	9.1ft	3.7fc	9.1ft	6.7fc	9.1ft	9.8fc	9.1ft	12.7fc	9.1ft
16ft	0.9fc	12.2ft	2.1fc	12.2ft	3.8fc	12.2ft	5.5fc	12.2ft	7.1fc	12.2ft
24ft	0.4fc	18.2ft	0.9fc	18.2ft	1.7fc	18.2ft	2.5fc	18.2ft	3.2fc	18.2ft
32ft	0.2fc	24.3ft	0.5fc	24.3ft	0.9fc	24.3ft	1.4fc	24.3ft	1.8fc	24.3ft
40ft	0.1fc	30.4ft	0.3fc	30.4ft	0.6fc	30.4ft	0.9fc	30.4ft	1.1fc	30.4ft
48ft	0.1fc	36.5ft	0.2fc	36.5ft	0.4fc	36.5ft	0.6fc	36.5ft	0.8fc	36.5ft
60ft	0.1fc	45.6ft	0.1fc	45.6ft	0.3fc	45.6ft	0.4fc	45.6ft	0.5fc	45.6ft

At 60° Setting



POWER	1W		2W		8W		15W		18W	
DISTANCE	FOOT CANDLES	BEAM WIDTH	FOOT CANDLES	BEAM WIDTH	FOOT CANDLES	BEAM WIDTH	FOOT CANDLES	BEAM WIDTH	FOOT CANDLES	BEAM WIDTH
4ft	9.0fc	4.5ft	16.6fc	4.5ft	41.2fc	4.5ft	54.0fc	4.5ft	70.1fc	4.5ft
8ft	2.3fc	8.9ft	4.1fc	8.9ft	10.3fc	8.9ft	13.5fc	8.9ft	17.5fc	8.9ft
12ft	1.0fc	13.4ft	1.8fc	13.4ft	4.6fc	13.4ft	6.0fc	13.4ft	7.8fc	13.4ft
16ft	0.6fc	17.9ft	1.0fc	17.9ft	2.6fc	17.9ft	3.4fc	17.9ft	4.4fc	17.9ft
24ft	0.3fc	26.8ft	0.5fc	26.8ft	1.1fc	26.8ft	1.5fc	26.8ft	1.9fc	26.8ft
32ft	0.1fc	35.8ft	0.3fc	35.8ft	0.6fc	35.8ft	0.8fc	35.8ft	1.1fc	35.8ft
40ft	0.1fc	44.7ft	0.2fc	44.7ft	0.4fc	44.7ft	0.5fc	44.7ft	0.7fc	44.7ft
48ft	0.1fc	53.7ft	0.1fc	53.7ft	0.3fc	53.7ft	0.4fc	53.7ft	0.5fc	53.7ft
60ft	0.0fc	67.1ft	0.1fc	67.1ft	0.2fc	67.1ft	0.2fc	67.1ft	0.3fc	67.1ft

ACCENT 120V PHOTOMETRICS

At 15° Setting	POWER	3.5W		6.5W		10.5W		13.5W		14.5W	
	DISTANCE	FOOT CANDLES	BEAM WIDTH	FOOT CANDLES	BEAM WIDTH	FOOT CANDLES	BEAM WIDTH	FOOT CANDLES	BEAM WIDTH	FOOT CANDLES	BEAM WIDTH
	4ft	50.4fc	1.1ft	102.4fc	1.1ft	151.8fc	1.1ft	192.9fc	1.1ft	200.3fc	1.1ft
	8ft	12.6fc	2.1ft	25.6fc	2.1ft	37.9fc	2.1ft	48.2fc	2.1ft	50.1fc	2.1ft
	12ft	5.6fc	3.2ft	11.4fc	3.2ft	16.9fc	3.2ft	21.4fc	3.2ft	22.3fc	3.2ft
	16ft	3.1fc	4.2ft	6.4fc	4.2ft	9.5fc	4.2ft	12.1fc	4.2ft	12.5fc	4.2ft
	24ft	1.4fc	6.3ft	2.8fc	6.3ft	4.2fc	6.3ft	5.4fc	6.3ft	5.6fc	6.3ft
	32ft	0.8fc	8.4ft	1.6fc	8.4ft	2.4fc	8.4ft	3.0fc	8.4ft	3.1fc	8.4ft
	40ft	0.5fc	10.5ft	1.0fc	10.5ft	1.5fc	10.5ft	1.9fc	10.5ft	2.0fc	10.5ft
	48ft	0.3fc	12.6ft	0.7fc	12.6ft	1.1fc	12.6ft	1.3fc	12.6ft	1.4fc	12.6ft
	60ft	0.2fc	15.8ft	0.5fc	15.8ft	0.7fc	15.8ft	0.9fc	15.8ft	0.9fc	15.8ft

At 25° Setting	POWER	3.5W		6.5W		10.5W		13.5W		14.5W	
	DISTANCE	FOOT CANDLES	BEAM WIDTH	FOOT CANDLES	BEAM WIDTH	FOOT CANDLES	BEAM WIDTH	FOOT CANDLES	BEAM WIDTH	FOOT CANDLES	BEAM WIDTH
	4ft	37.2fc	1.8ft	73.1fc	1.8ft	113.1fc	1.8ft	139.2fc	1.8ft	149.1fc	1.8ft
	8ft	9.3fc	3.5ft	18.3fc	3.5ft	28.3fc	3.5ft	34.8fc	3.5ft	37.3fc	3.5ft
	12ft	4.1fc	5.3ft	8.1fc	5.3ft	12.6fc	5.3ft	15.5fc	5.3ft	16.6fc	5.3ft
	16ft	2.3fc	7.1ft	4.6fc	7.1ft	7.1fc	7.1ft	8.7fc	7.1ft	9.3fc	7.1ft
	24ft	1.0fc	10.6ft	2.0fc	10.6ft	3.1fc	10.6ft	3.9fc	10.6ft	4.1fc	10.6ft
	32ft	0.6fc	14.2ft	1.1fc	14.2ft	1.8fc	14.2ft	2.2fc	14.2ft	2.3fc	14.2ft
	40ft	0.4fc	17.7ft	0.7fc	17.7ft	1.1fc	17.7ft	1.4fc	17.7ft	1.5fc	17.7ft
	48ft	0.3fc	21.3ft	0.5fc	21.3ft	0.8fc	21.3ft	1.0fc	21.3ft	1.0fc	21.3ft
	60ft	0.2fc	26.6ft	0.3fc	26.6ft	0.5fc	26.6ft	0.6fc	26.6ft	0.7fc	26.6ft

At 40° Setting	POWER	3.5W		6.5W		10.5W		13.5W		14.5W	
	DISTANCE	FOOT CANDLES	BEAM WIDTH	FOOT CANDLES	BEAM WIDTH	FOOT CANDLES	BEAM WIDTH	FOOT CANDLES	BEAM WIDTH	FOOT CANDLES	BEAM WIDTH
	4ft	20.7fc	3.0ft	36.7fc	3.0ft	63.4fc	3.0ft	81.9fc	3.0ft	85.9fc	3.0ft
	8ft	5.2fc	6.1ft	9.2fc	6.1ft	15.8fc	6.1ft	20.5fc	6.1ft	21.5fc	6.1ft
	12ft	2.3fc	9.1ft	4.1fc	9.1ft	7.0fc	9.1ft	9.1fc	9.1ft	9.5fc	9.1ft
	16ft	1.3fc	12.2ft	2.3fc	12.2ft	4.0fc	12.2ft	5.1fc	12.2ft	5.4fc	12.2ft
	24ft	0.6fc	18.2ft	1.0fc	18.2ft	1.8fc	18.2ft	2.3fc	18.2ft	2.4fc	18.2ft
	32ft	0.3fc	24.3ft	0.6fc	24.3ft	1.0fc	24.3ft	1.3fc	24.3ft	1.3fc	24.3ft
	40ft	0.2fc	30.4ft	0.4fc	30.4ft	0.6fc	30.4ft	0.8fc	30.4ft	0.9fc	30.4ft
	48ft	0.1fc	36.5ft	0.3fc	36.5ft	0.4fc	36.5ft	0.6fc	36.5ft	0.6fc	36.5ft
	60ft	0.1fc	45.6ft	0.2fc	45.6ft	0.3fc	45.6ft	0.4fc	45.6ft	0.4fc	45.6ft

At 60° Setting	POWER	3.5W		6.5W		10.5W		13.5W		14.5W	
	DISTANCE	FOOT CANDLES	BEAM WIDTH	FOOT CANDLES	BEAM WIDTH	FOOT CANDLES	BEAM WIDTH	FOOT CANDLES	BEAM WIDTH	FOOT CANDLES	BEAM WIDTH
	4ft	13.2fc	4.5ft	24.5fc	4.5ft	33.1fc	4.5ft	46.6fc	4.5ft	53.6fc	4.5ft
	8ft	3.3fc	8.9ft	6.1fc	8.9ft	8.3fc	8.9ft	11.7fc	8.9ft	13.4fc	8.9ft
	12ft	1.5fc	13.4ft	2.7fc	13.4ft	3.7fc	13.4ft	5.2fc	13.4ft	6.0fc	13.4ft
	16ft	0.8fc	17.9ft	1.5fc	17.9ft	2.1fc	17.9ft	2.9fc	17.9ft	3.4fc	17.9ft
	24ft	0.4fc	26.8ft	0.7fc	26.8ft	0.9fc	26.8ft	1.3fc	26.8ft	1.5fc	26.8ft
	32ft	0.2fc	35.8ft	0.4fc	35.8ft	0.5fc	35.8ft	0.7fc	35.8ft	0.8fc	35.8ft
	40ft	0.1fc	44.7ft	0.2fc	44.7ft	0.3fc	44.7ft	0.5fc	44.7ft	0.5fc	44.7ft
	48ft	0.1fc	53.7ft	0.2fc	53.7ft	0.2fc	53.7ft	0.3fc	53.7ft	0.4fc	53.7ft
	60ft	0.1fc	67.1ft	0.1fc	67.1ft	0.1fc	67.1ft	0.2fc	67.1ft	0.2fc	67.1ft

MINI ACCENT 12V PHOTOMETRICS

At 10° Setting



POWER	1W		2W		4W		6W		7W	
DISTANCE	FOOT CANDLES	BEAM WIDTH	FOOT CANDLES	BEAM WIDTH	FOOT CANDLES	BEAM WIDTH	FOOT CANDLES	BEAM WIDTH	FOOT CANDLES	BEAM WIDTH
4ft	83.1fc	0.6ft	122.8fc	0.6ft	181.0fc	0.6ft	244.1fc	0.6ft	274.9fc	0.6ft
8ft	20.8fc	1.2ft	30.7fc	1.2ft	45.3fc	1.2ft	61.0fc	1.2ft	68.7fc	1.2ft
12ft	9.2fc	1.8ft	13.6fc	1.8ft	20.1fc	1.8ft	27.1fc	1.8ft	30.5fc	1.8ft
16ft	5.2fc	2.3ft	7.7fc	2.3ft	11.3fc	2.3ft	15.3fc	2.3ft	17.2fc	2.3ft
24ft	2.3fc	3.5ft	3.4fc	3.5ft	5.0fc	3.5ft	6.8fc	3.5ft	7.6fc	3.5ft
32ft	1.3fc	4.7ft	1.9fc	4.7ft	2.8fc	4.7ft	3.8fc	4.7ft	4.3fc	4.7ft
40ft	0.8fc	5.9ft	1.2fc	5.9ft	1.8fc	5.9ft	2.4fc	5.9ft	2.7fc	5.9ft
48ft	0.6fc	7.0ft	0.9fc	7.0ft	1.3fc	7.0ft	1.7fc	7.0ft	1.9fc	7.0ft
60ft	0.4fc	8.8ft	0.5fc	8.8ft	0.8fc	8.8ft	1.1fc	8.8ft	1.2fc	8.8ft

At 25° Setting



POWER	1W		2W		4W		6W		7W	
DISTANCE	FOOT CANDLES	BEAM WIDTH	FOOT CANDLES	BEAM WIDTH	FOOT CANDLES	BEAM WIDTH	FOOT CANDLES	BEAM WIDTH	FOOT CANDLES	BEAM WIDTH
4ft	22.8fc	1.9ft	36.0fc	1.9ft	52.7fc	1.9ft	71.1fc	1.9ft	76.8fc	1.9ft
8ft	5.7fc	3.7ft	9.0fc	3.7ft	13.2fc	3.7ft	17.8fc	3.7ft	19.2fc	3.7ft
12ft	2.5fc	5.6ft	4.0fc	5.6ft	5.9fc	5.6ft	7.9fc	5.6ft	8.5fc	5.6ft
16ft	1.4fc	7.4ft	2.2fc	7.4ft	3.3fc	7.4ft	4.4fc	7.4ft	4.8fc	7.4ft
24ft	0.6fc	11.1ft	1.0fc	11.1ft	1.5fc	11.1ft	2.0fc	11.1ft	2.1fc	11.1ft
32ft	0.4fc	14.8ft	0.6fc	14.8ft	0.8fc	14.8ft	1.1fc	14.8ft	1.2fc	14.8ft
40ft	0.2fc	18.5ft	0.4fc	18.5ft	0.5fc	18.5ft	0.7fc	18.5ft	0.8fc	18.5ft
48ft	0.2fc	22.3ft	0.2fc	22.3ft	0.4fc	22.3ft	0.5fc	22.3ft	0.5fc	22.3ft
60ft	0.1fc	27.8ft	0.2fc	27.8ft	0.2fc	27.8ft	0.3fc	27.8ft	0.3fc	27.8ft

At 40° Setting



POWER	1W		2W		4W		6W		7W	
DISTANCE	FOOT CANDLES	BEAM WIDTH	FOOT CANDLES	BEAM WIDTH	FOOT CANDLES	BEAM WIDTH	FOOT CANDLES	BEAM WIDTH	FOOT CANDLES	BEAM WIDTH
4ft	13.0fc	3.1ft	20.7fc	3.1ft	27.7fc	3.1ft	39.6fc	3.1ft	42.0fc	3.1ft
8ft	3.3fc	6.1ft	5.2fc	6.1ft	6.9fc	6.1ft	9.9fc	6.1ft	10.5fc	6.1ft
12ft	1.4fc	9.2ft	2.3fc	9.2ft	3.1fc	9.2ft	4.4fc	9.2ft	4.7fc	9.2ft
16ft	0.8fc	12.3ft	1.3fc	12.3ft	1.7fc	12.3ft	2.5fc	12.3ft	2.6fc	12.3ft
24ft	0.4fc	18.4ft	0.6fc	18.4ft	0.8fc	18.4ft	1.1fc	18.4ft	1.2fc	18.4ft
32ft	0.2fc	24.5ft	0.3fc	24.5ft	0.4fc	24.5ft	0.6fc	24.5ft	0.7fc	24.5ft
40ft	0.1fc	30.6ft	0.2fc	30.6ft	0.3fc	30.6ft	0.4fc	30.6ft	0.4fc	30.6ft
48ft	0.1fc	36.8ft	0.1fc	36.8ft	0.2fc	36.8ft	0.3fc	36.8ft	0.3fc	36.8ft
60ft	0.1fc	45.9ft	0.1fc	45.9ft	0.1fc	45.9ft	0.2fc	45.9ft	0.2fc	45.9ft

At 50° Setting



POWER	1W		2W		4W		6W		7W	
DISTANCE	FOOT CANDLES	BEAM WIDTH	FOOT CANDLES	BEAM WIDTH	FOOT CANDLES	BEAM WIDTH	FOOT CANDLES	BEAM WIDTH	FOOT CANDLES	BEAM WIDTH
4ft	9.0fc	3.9ft	12.3fc	3.9ft	16.9fc	3.9ft	25.0fc	3.9ft	29.8fc	3.9ft
8ft	2.3fc	7.7ft	3.1fc	7.7ft	4.2fc	7.7ft	6.2fc	7.7ft	7.4fc	7.7ft
12ft	1.0fc	11.6ft	1.4fc	11.6ft	1.9fc	11.6ft	2.8fc	11.6ft	3.3fc	11.6ft
16ft	0.6fc	15.5ft	0.8fc	15.5ft	1.1fc	15.5ft	1.6fc	15.5ft	1.9fc	15.5ft
24ft	0.3fc	23.2ft	0.3fc	23.2ft	0.5fc	23.2ft	0.7fc	23.2ft	0.8fc	23.2ft
32ft	0.1fc	30.9ft	0.2fc	30.9ft	0.3fc	30.9ft	0.4fc	30.9ft	0.5fc	30.9ft
40ft	0.1fc	38.7ft	0.1fc	38.7ft	0.2fc	38.7ft	0.2fc	38.7ft	0.3fc	38.7ft
48ft	0.1fc	46.4ft	0.1fc	46.4ft	0.1fc	46.4ft	0.2fc	46.4ft	0.2fc	46.4ft
60ft	0.0fc	58.0ft	0.1fc	58.0ft	0.1fc	58.0ft	0.1fc	58.0ft	0.1fc	58.0ft

INTERBEAM 12V PHOTOMETRICS

5311

At 20° Setting	POWER	6W	
	DISTANCE	FOOT CANDLES	BEAM WIDTH
	4ft	107.3fc	1.5ft
	8ft	26.8fc	3.0ft
	12ft	11.9fc	4.0ft
	16ft	6.7fc	5.5ft
	24ft	3.0fc	8.5ft
	32ft	1.7fc	11.5ft
	40ft	1.1fc	14.0ft
	48ft	0.7fc	17.0ft
	60ft	0.5fc	20.0ft

5411

At 20° Setting	POWER	3W	
	DISTANCE	FOOT CANDLES	BEAM WIDTH
	4ft	51.3fc	1.5ft
	8ft	12.8fc	3.0ft
	12ft	5.7fc	4.0ft
	16ft	3.2fc	5.5ft
	24ft	1.4fc	8.5ft
	32ft	0.8fc	11.5ft
	40ft	0.5fc	14.0ft
	48ft	0.4fc	17.0ft
	60ft	0.2fc	21.0ft

At 35° Setting	POWER	6W	
	DISTANCE	FOOT CANDLES	BEAM WIDTH
	4ft	61.9fc	2.5ft
	8ft	15.5fc	5.0ft
	12ft	2.7fc	6.4ft
	16ft	6.9fc	7.5ft
	24ft	3.9fc	10.0ft
	32ft	1.7fc	15.0ft
	40ft	1.0fc	20.0ft
	48ft	0.4fc	30.5ft
	60ft	0.3fc	38.0ft

At 35° Setting	POWER	3W	
	DISTANCE	FOOT CANDLES	BEAM WIDTH
	4ft	32.3fc	2.5ft
	8ft	8.1fc	5.0ft
	12ft	3.6fc	7.5ft
	16ft	2.0fc	10.0ft
	24ft	0.9fc	15.0ft
	32ft	0.5fc	20.0ft
	40ft	0.3fc	25.0ft
	48ft	0.2fc	30.5ft
	60ft	0.1fc	38.0ft

At 60° Setting	POWER	6W	
	DISTANCE	FOOT CANDLES	BEAM WIDTH
	4ft	34.4fc	4.5ft
	8ft	8.6fc	9.0ft
	12ft	3.8fc	14.0ft
	16ft	2.2fc	18.5ft
	24ft	1.0fc	27.5ft
	32ft	0.5fc	37.0ft
	40ft	0.3fc	46.0ft
	48ft	0.2fc	55.5ft
	60ft	0.2fc	69.5ft

At 60° Setting	POWER	3W	
	DISTANCE	FOOT CANDLES	BEAM WIDTH
	4ft	15.4fc	4.5ft
	8ft	3.8fc	9.0ft
	12ft	1.7fc	14.0ft
	16ft	1.0fc	18.5ft
	24ft	0.4fc	27.5ft
	32ft	0.2fc	37.0ft
	40ft	0.2fc	46.0ft
	48ft	0.1fc	55.5ft
	60ft	0.1fc	69.5ft

HORNET 12V PHOTOMETRICS

5611

At 20° Setting	POWER	10.5W	
	DISTANCE	FOOT CANDLES	BEAM WIDTH
	4ft	165.5fc	1.4ft
	8ft	41.4fc	2.8ft
	12ft	18.4fc	4.2ft
	16ft	10.3fc	5.6ft
	24ft	4.6fc	8.5ft
	32ft	2.6fc	11.3ft
	40ft	1.7fc	14.1ft
	48ft	1.1fc	16.9ft
	60ft	0.7fc	21.2ft

At 35° Setting	POWER	10.5W	
	DISTANCE	FOOT CANDLES	BEAM WIDTH
	4ft	91.1fc	2.5ft
	8ft	22.8fc	5.0ft
	12ft	10.1fc	7.6ft
	16ft	5.7fc	10.1ft
	24ft	2.5fc	15.1ft
	32ft	1.4fc	20.2ft
	40ft	0.9fc	25.2ft
	48ft	0.6fc	30.3ft
	60ft	0.4fc	37.8ft

At 45° Setting	POWER	10.5W	
	DISTANCE	FOOT CANDLES	BEAM WIDTH
	4ft	62.8fc	3.5ft
	8ft	15.7fc	6.5ft
	12ft	7.0fc	10.0ft
	16ft	3.9fc	13.5ft
	24ft	1.7fc	20.0ft
	32ft	1.0fc	26.5ft
	40ft	0.6fc	33.0ft
	48ft	0.4fc	40.0ft
	60ft	0.3fc	49.5ft

At 60° Setting	POWER	10.5W	
	DISTANCE	FOOT CANDLES	BEAM WIDTH
	4ft	47.7fc	4.6ft
	8ft	11.9fc	9.2ft
	12ft	5.3fc	13.9ft
	16ft	3.0fc	18.5ft
	24ft	1.3fc	27.7ft
	32ft	0.7fc	37.0ft
	40ft	0.5fc	46.2ft
	48ft	0.3fc	55.4ft
	60ft	0.2fc	69.3ft

At 70° Setting	POWER	10.5W	
	DISTANCE	FOOT CANDLES	BEAM WIDTH
	4ft	40.4fc	5.6ft
	8ft	10.1fc	11.2ft
	12ft	4.5fc	16.8ft
	16ft	2.5fc	22.4ft
	24ft	1.1fc	33.6ft
	32ft	0.6fc	44.8ft
	40ft	0.4fc	56.0ft
	48ft	0.3fc	67.2ft
	60ft	0.2fc	84.0ft

ADJUSTABLE BEAM WALL WASH PHOTOMETRICS

FIXTURE	MOUNTING DISTANCE (d)	A	B	C	D	E	F
5221/5222 (4X3)	3ft	27.9fc	11.3fc	5.6fc	1.5fc	0.05fc	0.02fc
	4ft	15.7fc	6.3fc	3.2fc	0.85fc	0.03fc	0.01fc
	5ft	10.1fc	4.1fc	2fc	0.53fc	0.02fc	0.01fc
	6ft	7fc	2.8fc	1.4fc	0.37fc	0.01fc	-
	7ft	5.1fc	2.1fc	1fc	0.28fc	0.01fc	-
	8ft	4fc	1.6fc	0.79fc	0.21fc	0.01fc	-
	9ft	3.1fc	1.3fc	0.62fc	0.17fc	0.01fc	-
10ft	2.5fc	1.0fc	0.51fc	0.14fc	-	-	

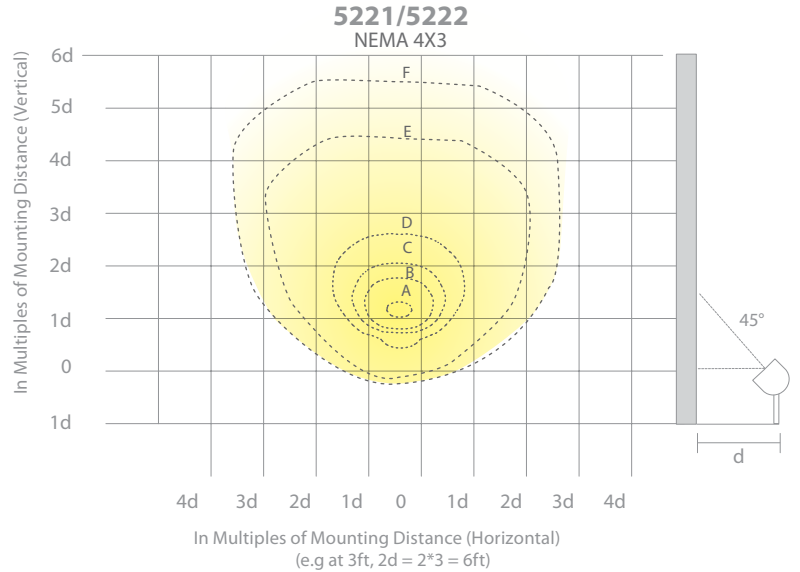

FIXTURE	MOUNTING DISTANCE (d)	A	B	C	D	E	F
5221/5222 (5X4)	3ft	28.9fc	13.4fc	7.9fc	3fc	0.36fc	0.14fc
	4ft	16.3fc	7.5fc	4.4fc	1.7fc	0.20fc	0.08fc
	5ft	10.4fc	4.8fc	2.8fc	1.1fc	0.13fc	0.05fc
	6ft	7.3fc	3.4fc	2.0fc	0.75fc	0.09fc	0.04fc
	7ft	5.3fc	2.5fc	1.5fc	0.55fc	0.07fc	0.03fc
	8ft	4.1fc	1.9fc	1.1fc	0.42fc	0.05fc	0.02fc
	9ft	3.2fc	1.5fc	0.87fc	0.33fc	0.04fc	0.02fc
10ft	2.6fc	1.2fc	0.71fc	0.27fc	0.03fc	0.01fc	

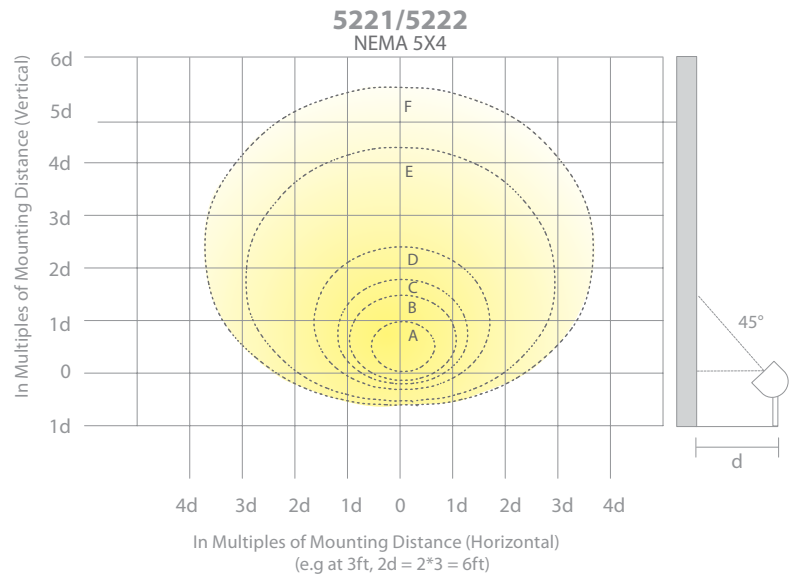

FIXTURE	MOUNTING DISTANCE (d)	A	B	C	D	E	F
5221/5222 (6X5)	3ft	28.9fc	13.6fc	8.8fc	4.1fc	0.70fc	0.32fc
	4ft	16.3fc	7.7fc	5.0fc	2.3fc	0.39fc	0.18fc
	5ft	10.4fc	4.9fc	3.2fc	1.5fc	0.25fc	0.12fc
	6ft	7.2fc	3.4fc	2.2fc	1.0fc	0.18fc	0.08fc
	7ft	5.3fc	2.5fc	1.6fc	0.75fc	0.13fc	0.06fc
	8ft	4.1fc	1.9fc	1.2fc	0.58fc	0.10fc	0.05fc
	9ft	3.2fc	1.5fc	0.98fc	0.45fc	0.08fc	0.04fc
10ft	2.6fc	1.2fc	0.79fc	0.37fc	0.06fc	0.03fc	

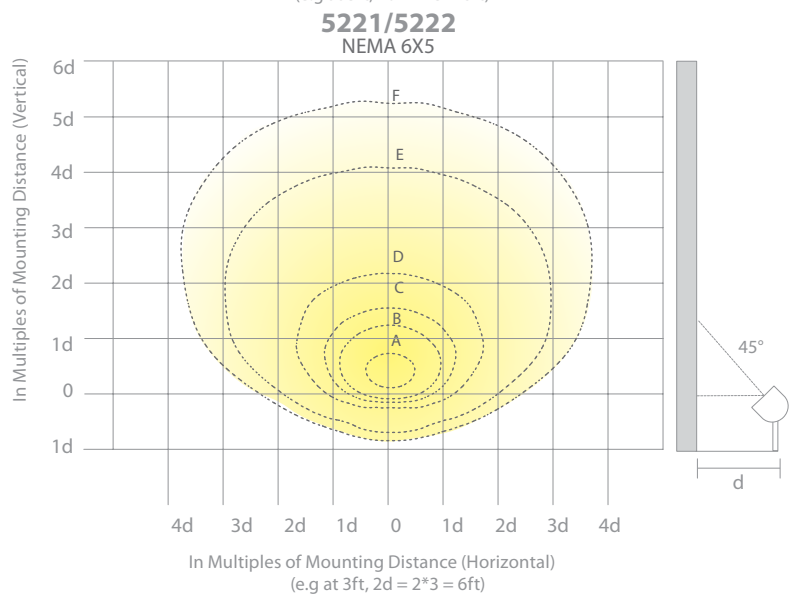

WALL WASH PHOTOMETRICS

FIXTURE	MOUNTING DISTANCE (d)	A	B	C	D	E	F
5021-30	3ft	27.5fc	16.3fc	10.9fc	4.7fc	0.72fc	0.33fc
	4ft	15.6fc	9.6fc	5.9fc	2.7fc	0.40fc	0.18fc
	5ft	10fc	5.9fc	4.0fc	1.3fc	0.26fc	0.12fc
	6ft	6.8fc	4.1fc	2.7fc	1.2fc	0.18fc	0.08fc
	7ft	5fc	3.1fc	2.0fc	0.88fc	0.13fc	0.06fc
	8ft	3.9fc	2.4fc	1.6fc	0.67fc	0.10fc	0.05fc
	9ft	3.1fc	1.8fc	1.2fc	0.54fc	0.08fc	0.04fc
	10ft	2.5fc	1.5fc	0.99fc	0.44fc	0.06fc	0.03fc

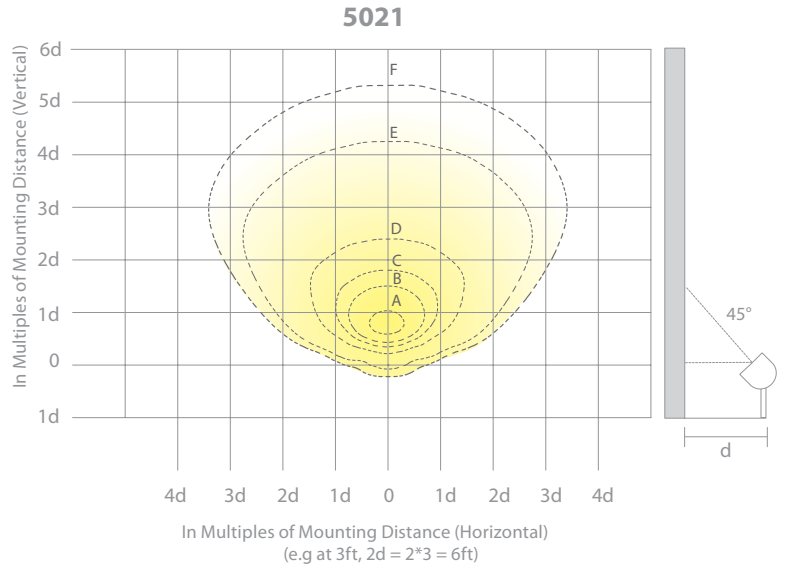

FIXTURE	MOUNTING DISTANCE (d)	A	B	C	D	E	F
5022-30	3ft	27.5fc	16.3fc	10.9fc	4.7fc	0.72fc	0.33fc
	4ft	15.6fc	9.6fc	5.9fc	2.7fc	0.40fc	0.18fc
	5ft	10fc	5.9fc	4.0fc	1.3fc	0.26fc	0.12fc
	6ft	6.8fc	4.1fc	2.7fc	1.2fc	0.18fc	0.08fc
	7ft	5fc	3.1fc	2.0fc	0.88fc	0.13fc	0.06fc
	8ft	3.9fc	2.4fc	1.6fc	0.67fc	0.10fc	0.05fc
	9ft	3.1fc	1.8fc	1.2fc	0.54fc	0.08fc	0.04fc
	10ft	2.5fc	1.5fc	0.99fc	0.44fc	0.06fc	0.03fc

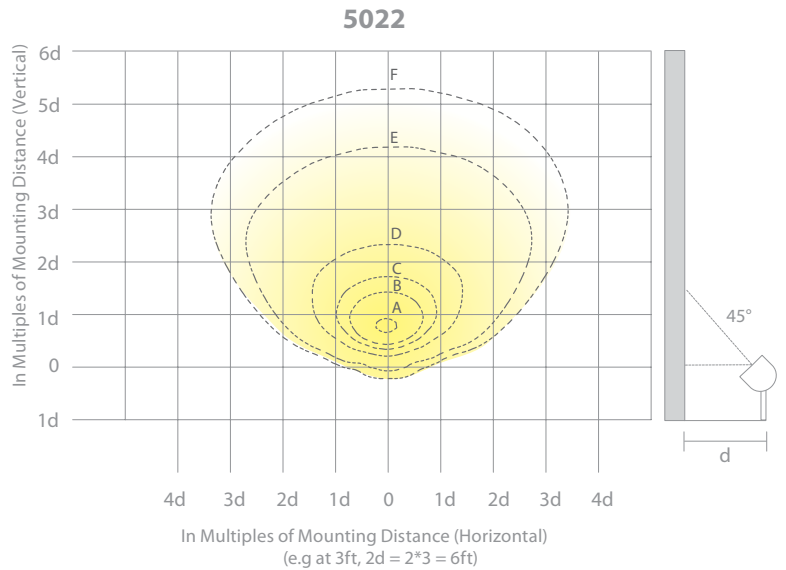

FIXTURE	MOUNTING DISTANCE (d)	A	B	C	D	E	F
5121-30	3ft	27.5fc	16.3fc	10.9fc	4.7fc	0.72fc	0.33fc
	4ft	15.6fc	9.6fc	5.9fc	2.7fc	0.40fc	0.18fc
	5ft	10fc	5.9fc	4.0fc	1.3fc	0.26fc	0.12fc
	6ft	6.8fc	4.1fc	2.7fc	1.2fc	0.18fc	0.08fc
	7ft	5fc	3.1fc	2.0fc	0.88fc	0.13fc	0.06fc
	8ft	3.9fc	2.4fc	1.6fc	0.67fc	0.10fc	0.05fc
	9ft	3.1fc	1.8fc	1.2fc	0.54fc	0.08fc	0.04fc
	10ft	2.5fc	1.5fc	0.99fc	0.44fc	0.06fc	0.03fc

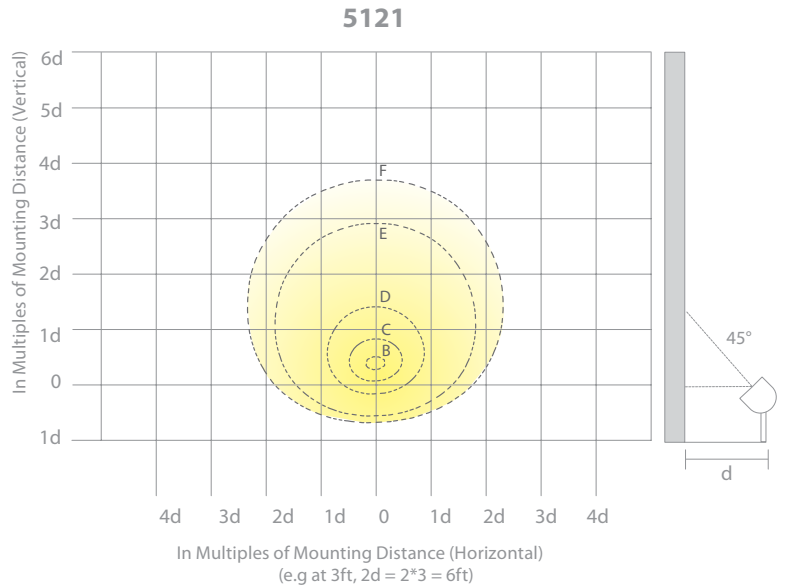

GRAND INGROUND 120V PHOTOMETRICS

At 20° Setting



DISTANCE	4W		8W		20W		24W	
	FOOT CANDLES	BEAM WIDTH	FOOT CANDLES	BEAM WIDTH	FOOT CANDLES	BEAM WIDTH	FOOT CANDLES	BEAM WIDTH
4ft	81.6fc	1.4ft	180.8fc	1.4ft	418.8fc	1.4ft	474.3fc	1.5ft
8ft	20.4fc	2.8ft	45.2fc	2.8ft	104.7fc	2.8ft	118.6fc	3.0ft
12ft	9.1fc	4.2ft	20.1fc	4.2ft	46.5fc	4.2ft	52.7fc	4.0ft
16ft	5.1fc	5.6ft	11.3fc	5.6ft	26.2fc	5.6ft	29.6fc	5.5ft
24ft	2.3fc	8.5ft	5.0fc	8.5ft	11.6fc	8.5ft	13.2fc	8.5ft
32ft	1.3fc	11.3ft	2.8fc	11.3ft	6.5fc	11.3ft	7.4fc	11.5ft
40ft	0.8fc	14.1ft	1.8fc	14.1ft	4.2fc	14.1ft	4.7fc	14.0ft
48ft	0.6fc	16.9ft	1.3fc	16.9ft	2.9fc	16.9ft	3.3fc	17.0ft
60ft	0.4fc	21.2ft	0.8fc	21.2ft	1.9fc	21.2ft	2.1fc	21.0ft

At 30° Setting



DISTANCE	4W		8W		20W		24W	
	FOOT CANDLES	BEAM WIDTH	FOOT CANDLES	BEAM WIDTH	FOOT CANDLES	BEAM WIDTH	FOOT CANDLES	BEAM WIDTH
4ft	60.4fc	2.1ft	134.3fc	2.1ft	311.0fc	2.1ft	351.4fc	2.1ft
8ft	15.1fc	4.3ft	33.6fc	4.3ft	77.8fc	4.3ft	87.9fc	4.3ft
12ft	6.7fc	6.4ft	14.9fc	6.4ft	34.6fc	6.4ft	39.0fc	6.4ft
16ft	3.8fc	8.6ft	8.4fc	8.6ft	19.4fc	8.6ft	22.0fc	8.6ft
24ft	1.7fc	12.9ft	3.7fc	12.9ft	8.6fc	12.9ft	9.8fc	12.9ft
32ft	0.9fc	17.1ft	2.1fc	17.1ft	4.9fc	17.1ft	5.5fc	17.1ft
40ft	0.6fc	21.4ft	1.3fc	21.4ft	3.1fc	21.4ft	3.5fc	21.4ft
48ft	0.4fc	25.7ft	0.9fc	25.7ft	2.2fc	25.7ft	2.4fc	25.7ft
60ft	0.3fc	32.2ft	0.6fc	32.2ft	1.4fc	32.2ft	1.6fc	32.2ft

At 40° Setting



DISTANCE	4W		8W		20W		24W	
	FOOT CANDLES	BEAM WIDTH	FOOT CANDLES	BEAM WIDTH	FOOT CANDLES	BEAM WIDTH	FOOT CANDLES	BEAM WIDTH
4ft	37.1fc	2.9ft	81.7fc	2.9ft	188.9fc	2.9ft	215.6fc	2.9ft
8ft	9.3fc	5.8ft	20.4fc	5.8ft	47.2fc	5.8ft	53.9fc	5.8ft
12ft	4.1fc	8.7ft	9.1fc	8.7ft	21.0fc	8.7ft	24.0fc	8.7ft
16ft	2.3fc	11.6ft	5.1fc	11.6ft	11.8fc	11.6ft	13.5fc	11.6ft
24ft	1.0fc	17.5ft	2.3fc	17.5ft	5.2fc	17.5ft	6.0fc	17.5ft
32ft	0.6fc	23.3ft	1.3fc	23.3ft	3.0fc	23.3ft	3.4fc	23.3ft
40ft	0.4fc	29.1ft	0.8fc	29.1ft	1.9fc	29.1ft	2.2fc	29.1ft
48ft	0.3fc	34.9ft	0.6fc	34.9ft	1.3fc	34.9ft	1.5fc	34.9ft
60ft	0.2fc	43.7ft	0.4fc	43.7ft	0.8fc	43.7ft	1.0fc	43.7ft

At 50° Setting



DISTANCE	4W		8W		20W		24W	
	FOOT CANDLES	BEAM WIDTH	FOOT CANDLES	BEAM WIDTH	FOOT CANDLES	BEAM WIDTH	FOOT CANDLES	BEAM WIDTH
4ft	27.0fc	3.5ft	59.8fc	3.5ft	138.3fc	3.5ft	156.1fc	3.5ft
8ft	6.8fc	7.5ft	14.9fc	7.5ft	34.6fc	7.5ft	39.0fc	7.5ft
12ft	3.0fc	11.0ft	6.6fc	11.0ft	15.4fc	11.0ft	17.3fc	11.0ft
16ft	1.7fc	15.0ft	3.7fc	15.0ft	8.6fc	15.0ft	9.8fc	15.0ft
24ft	0.8fc	22.5ft	1.7fc	22.5ft	3.8fc	22.5ft	4.3fc	22.5ft
32ft	0.4fc	30.0ft	0.9fc	30.0ft	2.2fc	30.0ft	2.4fc	30.0ft
40ft	0.3fc	37.5ft	0.6fc	37.5ft	1.4fc	37.5ft	1.6fc	37.5ft
48ft	0.2fc	45.0ft	0.4fc	45.0ft	1.0fc	45.0ft	1.1fc	45.0ft
60ft	0.1fc	56.0ft	0.3fc	56.0ft	0.6fc	56.0ft	0.7fc	56.0ft

At 60° Setting



DISTANCE	4W		8W		20W		24W	
	FOOT CANDLES	BEAM WIDTH	FOOT CANDLES	BEAM WIDTH	FOOT CANDLES	BEAM WIDTH	FOOT CANDLES	BEAM WIDTH
4ft	21.5fc	4.6ft	47.6fc	4.6ft	111.3fc	4.6ft	125.9fc	4.6ft
8ft	5.4fc	9.2ft	11.9fc	9.2ft	27.8fc	9.2ft	31.5fc	9.2ft
12ft	2.4fc	13.9ft	5.3fc	13.9ft	12.4fc	13.9ft	14.0fc	13.9ft
16ft	1.3fc	18.5ft	3.0fc	18.5ft	7.0fc	18.5ft	7.9fc	18.5ft
24ft	0.6fc	27.7ft	1.3fc	27.7ft	3.1fc	27.7ft	3.5fc	27.7ft
32ft	0.3fc	37.0ft	0.7fc	37.0ft	1.7fc	37.0ft	2.0fc	37.0ft
40ft	0.2fc	46.2ft	0.5fc	46.2ft	1.1fc	46.2ft	1.3fc	46.2ft
48ft	0.1fc	55.4ft	0.3fc	55.4ft	0.8fc	55.4ft	0.9fc	55.4ft
60ft	0.1fc	69.3ft	0.2fc	69.3ft	0.5fc	69.3ft	0.6fc	69.3ft

GRAND INGROUND 12V PHOTOMETRICS

At 20° Setting	POWER	5W		9W		14W		20W		25W	
	DISTANCE	FOOT CANDLES	BEAM WIDTH	FOOT CANDLES	BEAM WIDTH	FOOT CANDLES	BEAM WIDTH	FOOT CANDLES	BEAM WIDTH	FOOT CANDLES	BEAM WIDTH
	4ft	99.3fc	1.5ft	161.6fc	1.5ft	263.5fc	1.5ft	375.3fc	1.5ft	445.1fc	1.5ft
8ft	24.8fc	3.0ft	40.4fc	3.0ft	65.9fc	3.0ft	93.8fc	3.0ft	111.3fc	3.0ft	
12ft	11.0fc	4.0ft	18.0fc	4.0ft	29.3fc	4.0ft	41.7fc	4.0ft	49.5fc	4.0ft	
16ft	6.2fc	5.5ft	10.1fc	5.5ft	16.5fc	5.5ft	23.5fc	5.5ft	27.8fc	5.5ft	
24ft	2.8fc	8.5ft	4.5fc	8.5ft	7.3fc	8.5ft	10.4fc	8.5ft	12.4fc	8.5ft	
32ft	1.6fc	11.5ft	2.5fc	11.5ft	4.1fc	11.5ft	5.9fc	11.5ft	7.0fc	11.5ft	
40ft	1.0fc	14.0ft	1.6fc	14.0ft	2.6fc	14.0ft	3.8fc	14.0ft	4.5fc	14.0ft	
48ft	0.7fc	17.0ft	1.1fc	17.0ft	1.8fc	17.0ft	2.6fc	17.0ft	3.1fc	17.0ft	
60ft	0.4fc	21.0ft	0.7fc	21.0ft	1.2fc	21.0ft	1.7fc	21.0ft	2.0fc	21.0ft	

At 30° Setting	POWER	5W		9W		14W		20W		25W	
	DISTANCE	FOOT CANDLES	BEAM WIDTH	FOOT CANDLES	BEAM WIDTH	FOOT CANDLES	BEAM WIDTH	FOOT CANDLES	BEAM WIDTH	FOOT CANDLES	BEAM WIDTH
	4ft	77.8fc	2.0ft	135.3fc	2.0ft	213.8fc	2.0ft	313.6fc	2.0ft	350.4fc	2.0ft
8ft	19.5fc	4.5ft	33.8fc	4.5ft	53.4fc	4.5ft	78.4fc	4.5ft	87.6fc	4.5ft	
12ft	8.6fc	6.5ft	15.0fc	6.5ft	23.8fc	6.5ft	34.8fc	6.5ft	38.9fc	6.5ft	
16ft	4.9fc	8.5ft	8.5fc	8.5ft	13.4fc	8.5ft	19.6fc	8.5ft	21.9fc	8.5ft	
24ft	2.2fc	13.0ft	3.8fc	13.0ft	5.9fc	13.0ft	8.7fc	13.0ft	9.7fc	13.0ft	
32ft	1.2fc	17.0ft	2.1fc	17.0ft	3.3fc	17.0ft	4.9fc	17.0ft	5.5fc	17.0ft	
40ft	0.8fc	21.5ft	1.4fc	21.5ft	2.1fc	21.5ft	3.1fc	21.5ft	3.5fc	21.5ft	
48ft	0.5fc	25.5ft	0.9fc	25.5ft	1.5fc	25.5ft	2.2fc	25.5ft	2.4fc	25.5ft	
60ft	0.3fc	32.0ft	0.6fc	32.0ft	1.0fc	32.0ft	1.4fc	32.0ft	1.6fc	32.0ft	

At 40° Setting	POWER	5W		9W		14W		20W		25W	
	DISTANCE	FOOT CANDLES	BEAM WIDTH	FOOT CANDLES	BEAM WIDTH	FOOT CANDLES	BEAM WIDTH	FOOT CANDLES	BEAM WIDTH	FOOT CANDLES	BEAM WIDTH
	4ft	52.1fc	3.0ft	86.0fc	3.0ft	136.3fc	3.0ft	198.5fc	3.0ft	220.6fc	3.0ft
8ft	13.0fc	6.0ft	21.5fc	6.1ft	34.1fc	6.1ft	49.6fc	6.1ft	55.1fc	6.1ft	
12ft	5.8fc	8.5ft	9.6fc	9.1ft	15.1fc	9.1ft	22.1fc	9.1ft	24.5fc	9.1ft	
16ft	3.3fc	11.5ft	5.4fc	12.2ft	8.5fc	12.2ft	12.4fc	12.2ft	13.8fc	12.2ft	
24ft	1.4fc	17.5ft	2.4fc	18.2ft	3.8fc	18.2ft	5.5fc	18.2ft	6.1fc	18.2ft	
32ft	0.8fc	23.5ft	1.3fc	24.3ft	2.1fc	24.3ft	3.1fc	24.3ft	3.4fc	24.3ft	
40ft	0.5fc	29.0ft	0.9fc	30.4ft	1.4fc	30.4ft	2.0fc	30.4ft	2.2fc	30.4ft	
48ft	0.4fc	35.0ft	0.6fc	36.5ft	0.9fc	36.5ft	1.4fc	36.5ft	1.5fc	36.5ft	
60ft	0.2fc	43.5ft	0.4fc	45.6ft	0.6fc	45.6ft	0.9fc	45.6ft	1.0fc	45.6ft	

At 50° Setting	POWER	5W		9W		14W		20W		25W	
	DISTANCE	FOOT CANDLES	BEAM WIDTH	FOOT CANDLES	BEAM WIDTH	FOOT CANDLES	BEAM WIDTH	FOOT CANDLES	BEAM WIDTH	FOOT CANDLES	BEAM WIDTH
	4ft	37.1fc	3.5ft	61.1fc	3.5ft	100.1fc	3.5ft	140.5fc	3.5ft	161.1fc	3.5ft
8ft	9.3fc	7.5ft	15.3fc	7.5ft	25.0fc	7.5ft	35.1fc	7.5ft	40.3fc	7.5ft	
12ft	4.1fc	11.0ft	6.8fc	11.0ft	11.1fc	11.0ft	15.6fc	11.0ft	17.9fc	11.0ft	
16ft	2.3fc	15.0ft	3.8fc	15.0ft	6.3fc	15.0ft	8.8fc	15.0ft	10.1fc	15.0ft	
24ft	1.0fc	22.5ft	1.7fc	22.5ft	2.8fc	22.5ft	3.9fc	22.5ft	4.5fc	22.5ft	
32ft	0.6fc	30.0ft	1.0fc	30.0ft	1.6fc	30.0ft	2.2fc	30.0ft	2.5fc	30.0ft	
40ft	0.4fc	37.5ft	0.6fc	37.5ft	1.0fc	37.5ft	1.4fc	37.5ft	1.6fc	37.5ft	
48ft	0.3fc	45.0ft	0.4fc	45.0ft	0.7fc	45.0ft	1.0fc	45.0ft	1.1fc	45.0ft	
60ft	0.2fc	56.0ft	0.3fc	56.0ft	0.4fc	56.0ft	0.6fc	56.0ft	0.7fc	56.0ft	

At 60° Setting	POWER	5W		9W		14W		20W		25W	
	DISTANCE	FOOT CANDLES	BEAM WIDTH	FOOT CANDLES	BEAM WIDTH	FOOT CANDLES	BEAM WIDTH	FOOT CANDLES	BEAM WIDTH	FOOT CANDLES	BEAM WIDTH
	4ft	28.9fc	4.5ft	47.6fc	4.5ft	76.7fc	4.5ft	111.2fc	4.5ft	124.7fc	4.5ft
8ft	7.2fc	9.0ft	11.9fc	9.0ft	19.2fc	9.0ft	27.8fc	9.0ft	31.2fc	9.0ft	
12ft	3.2fc	14.0ft	5.3fc	14.0ft	8.5fc	14.0ft	12.4fc	14.0ft	13.9fc	14.0ft	
16ft	1.8fc	18.5ft	3.0fc	18.5ft	4.8fc	18.5ft	6.9fc	18.5ft	7.8fc	18.5ft	
24ft	0.8fc	27.5ft	1.3fc	27.5ft	2.1fc	27.5ft	3.1fc	27.5ft	3.5fc	27.5ft	
32ft	0.5fc	37.0ft	0.7fc	37.0ft	1.2fc	37.0ft	1.7fc	37.0ft	1.9fc	37.0ft	
40ft	0.3fc	46.0ft	0.5fc	46.0ft	0.8fc	46.0ft	1.1fc	46.0ft	1.2fc	46.0ft	
48ft	0.2fc	55.5ft	0.3fc	55.5ft	0.5fc	55.5ft	0.8fc	55.5ft	0.9fc	55.5ft	
60ft	0.1fc	69.5ft	0.2fc	69.5ft	0.3fc	69.5ft	0.5fc	69.5ft	0.6fc	69.5ft	

3" INGROUND 12V PHOTOMETRICS

At 15° Setting



POWER	1W		2W		7W		13W		14W	
DISTANCE	FOOT CANDLES	BEAM WIDTH	FOOT CANDLES	BEAM WIDTH	FOOT CANDLES	BEAM WIDTH	FOOT CANDLES	BEAM WIDTH	FOOT CANDLES	BEAM WIDTH
4ft	47.2fc	1.1ft	75.8fc	1.1ft	165.3fc	1.1ft	236.2fc	1.1ft	283.4fc	1.1ft
8ft	11.8fc	2.1ft	18.9fc	2.1ft	41.3fc	2.1ft	59.0fc	2.1ft	70.9fc	2.1ft
12ft	5.2fc	3.2ft	8.4fc	3.2ft	18.4fc	3.2ft	26.2fc	3.2ft	31.5fc	3.2ft
16ft	3.0fc	4.2ft	4.7fc	4.2ft	10.3fc	4.2ft	14.8fc	4.2ft	17.7fc	4.2ft
24ft	1.3fc	6.3ft	2.1fc	6.3ft	4.6fc	6.3ft	6.6fc	6.3ft	7.9fc	6.3ft
32ft	0.7fc	8.4ft	1.2fc	8.4ft	2.6fc	8.4ft	3.7fc	8.4ft	4.4fc	8.4ft
40ft	0.5fc	10.5ft	0.8fc	10.5ft	1.7fc	10.5ft	2.4fc	10.5ft	2.8fc	10.5ft
48ft	0.3fc	12.6ft	0.5fc	12.6ft	1.1fc	12.6ft	1.6fc	12.6ft	2.0fc	12.6ft
60ft	0.2fc	15.8ft	0.3fc	15.8ft	0.7fc	15.8ft	1.0fc	15.8ft	1.3fc	15.8ft

At 30° Setting



POWER	1W		2W		7W		13W		14W	
DISTANCE	FOOT CANDLES	BEAM WIDTH	FOOT CANDLES	BEAM WIDTH	FOOT CANDLES	BEAM WIDTH	FOOT CANDLES	BEAM WIDTH	FOOT CANDLES	BEAM WIDTH
4ft	19.4fc	2.1ft	38.8fc	2.1ft	68.0fc	2.1ft	97.1fc	2.1ft	116.6fc	2.1ft
8ft	4.9fc	4.3ft	9.7fc	4.3ft	17.0fc	4.3ft	24.3fc	4.3ft	29.1fc	4.3ft
12ft	2.2fc	6.4ft	4.3fc	6.4ft	7.6fc	6.4ft	10.8fc	6.4ft	13.0fc	6.4ft
16ft	1.2fc	8.6ft	2.4fc	8.6ft	4.3fc	8.6ft	6.1fc	8.6ft	7.3fc	8.6ft
24ft	0.5fc	12.9ft	1.1fc	12.9ft	1.9fc	12.9ft	2.7fc	12.9ft	3.2fc	12.9ft
32ft	0.3fc	17.1ft	0.6fc	17.1ft	1.1fc	17.1ft	1.5fc	17.1ft	1.8fc	17.1ft
40ft	0.2fc	21.4ft	0.4fc	21.4ft	0.7fc	21.4ft	1.0fc	21.4ft	1.2fc	21.4ft
48ft	0.1fc	25.7ft	0.3fc	25.7ft	0.5fc	25.7ft	0.7fc	25.7ft	0.8fc	25.7ft
60ft	0.1fc	32.2ft	0.2fc	32.2ft	0.3fc	32.2ft	0.4fc	32.2ft	0.5fc	32.2ft

At 45° Setting



POWER	1W		2W		7W		13W		14W	
DISTANCE	FOOT CANDLES	BEAM WIDTH	FOOT CANDLES	BEAM WIDTH	FOOT CANDLES	BEAM WIDTH	FOOT CANDLES	BEAM WIDTH	FOOT CANDLES	BEAM WIDTH
4ft	10.9fc	3.3ft	21.8fc	3.3ft	38.1fc	3.3ft	54.4fc	3.3ft	65.3fc	3.3ft
8ft	2.7fc	6.6ft	5.4fc	6.6ft	9.5fc	6.6ft	13.6fc	6.6ft	16.3fc	6.6ft
12ft	1.2fc	9.9ft	2.4fc	9.9ft	4.2fc	9.9ft	6.0fc	9.9ft	7.3fc	9.9ft
16ft	0.7fc	13.3ft	1.4fc	13.3ft	2.4fc	13.3ft	3.4fc	13.3ft	4.1fc	13.3ft
24ft	0.3fc	19.9ft	0.6fc	19.9ft	1.1fc	19.9ft	1.5fc	19.9ft	1.8fc	19.9ft
32ft	0.2fc	26.5ft	0.3fc	26.5ft	0.6fc	26.5ft	0.9fc	26.5ft	1.0fc	26.5ft
40ft	0.1fc	33.1ft	0.2fc	33.1ft	0.4fc	33.1ft	0.5fc	33.1ft	0.7fc	33.1ft
48ft	0.1fc	39.8ft	0.2fc	39.8ft	0.3fc	39.8ft	0.4fc	39.8ft	0.5fc	39.8ft
60ft	0.0fc	49.7ft	0.1fc	49.7ft	0.2fc	49.7ft	0.2fc	49.7ft	0.3fc	49.7ft

At 60° Setting



POWER	1W		2W		7W		13W		14W	
DISTANCE	FOOT CANDLES	BEAM WIDTH	FOOT CANDLES	BEAM WIDTH	FOOT CANDLES	BEAM WIDTH	FOOT CANDLES	BEAM WIDTH	FOOT CANDLES	BEAM WIDTH
4ft	7.3fc	4.6ft	14.5fc	4.6ft	25.4fc	4.6ft	36.3fc	4.6ft	43.6fc	4.6ft
8ft	1.8fc	9.2ft	3.6fc	9.2ft	6.4fc	9.2ft	9.1fc	9.2ft	10.9fc	9.2ft
12ft	0.8fc	13.9ft	1.6fc	13.9ft	2.8fc	13.9ft	4.0fc	13.9ft	4.8fc	13.9ft
16ft	0.5fc	18.5ft	0.9fc	18.5ft	1.6fc	18.5ft	2.3fc	18.5ft	2.7fc	18.5ft
24ft	0.2fc	27.7ft	0.4fc	27.7ft	0.7fc	27.7ft	1.0fc	27.7ft	1.2fc	27.7ft
32ft	0.1fc	37.0ft	0.2fc	37.0ft	0.4fc	37.0ft	0.6fc	37.0ft	0.7fc	37.0ft
40ft	0.1fc	46.2ft	0.1fc	46.2ft	0.3fc	46.2ft	0.4fc	46.2ft	0.4fc	46.2ft
48ft	0.1fc	55.4ft	0.1fc	55.4ft	0.2fc	55.4ft	0.3fc	55.4ft	0.3fc	55.4ft
60ft	0.0fc	69.3ft	0.1fc	69.3ft	0.1fc	69.3ft	0.2fc	69.3ft	0.2fc	69.3ft

3" INGROUND 120V PHOTOMETRICS

At 15° Setting



POWER	3W		5.5W		8.5W		10.5W		11.5W	
DISTANCE	FOOT CANDLES	BEAM WIDTH	FOOT CANDLES	BEAM WIDTH	FOOT CANDLES	BEAM WIDTH	FOOT CANDLES	BEAM WIDTH	FOOT CANDLES	BEAM WIDTH
4ft	44.4fc	1.1ft	81.1fc	1.1ft	125.4fc	1.1ft	154.9fc	1.1ft	169.6fc	1.1ft
8ft	11.1fc	2.1ft	20.3fc	2.1ft	31.3fc	2.1ft	38.7fc	2.1ft	42.4fc	2.1ft
12ft	4.9fc	3.2ft	9.0fc	3.2ft	13.9fc	3.2ft	17.2fc	3.2ft	18.8fc	3.2ft
16ft	2.8fc	4.2ft	5.1fc	4.2ft	7.8fc	4.2ft	9.7fc	4.2ft	10.6fc	4.2ft
24ft	1.2fc	6.3ft	2.3fc	6.3ft	3.5fc	6.3ft	4.3fc	6.3ft	4.7fc	6.3ft
32ft	0.7fc	8.4ft	1.3fc	8.4ft	2.0fc	8.4ft	2.4fc	8.4ft	2.7fc	8.4ft
40ft	0.4fc	10.5ft	0.8fc	10.5ft	1.3fc	10.5ft	1.5fc	10.5ft	1.7fc	10.5ft
48ft	0.3fc	12.6ft	0.6fc	12.6ft	0.9fc	12.6ft	1.1fc	12.6ft	1.2fc	12.6ft
60ft	0.2fc	15.8ft	0.4fc	15.8ft	0.6fc	15.8ft	0.7fc	15.8ft	0.8fc	15.8ft

At 30° Setting



POWER	15W		22W		26W		30W		33W	
DISTANCE	FOOT CANDLES	BEAM WIDTH	FOOT CANDLES	BEAM WIDTH	FOOT CANDLES	BEAM WIDTH	FOOT CANDLES	BEAM WIDTH	FOOT CANDLES	BEAM WIDTH
4ft	24.5fc	2.1ft	45.1fc	2.1ft	69.6fc	2.1ft	86.0fc	2.1ft	94.2fc	2.1ft
8ft	6.1fc	4.3ft	11.3fc	4.3ft	17.4fc	4.3ft	21.5fc	4.3ft	23.5fc	4.3ft
12ft	2.7fc	6.4ft	5.0fc	6.4ft	7.7fc	6.4ft	9.6fc	6.4ft	10.5fc	6.4ft
16ft	1.5fc	8.6ft	2.8fc	8.6ft	4.4fc	8.6ft	5.4fc	8.6ft	5.9fc	8.6ft
24ft	0.7fc	12.9ft	1.3fc	12.9ft	1.9fc	12.9ft	2.4fc	12.9ft	2.6fc	12.9ft
32ft	0.4fc	17.1ft	0.7fc	17.1ft	1.1fc	17.1ft	1.3fc	17.1ft	1.5fc	17.1ft
40ft	0.2fc	21.4ft	0.5fc	21.4ft	0.7fc	21.4ft	0.9fc	21.4ft	0.9fc	21.4ft
48ft	0.2fc	25.7ft	0.3fc	25.7ft	0.5fc	25.7ft	0.6fc	25.7ft	0.7fc	25.7ft
60ft	0.1fc	32.2ft	0.2fc	32.2ft	0.3fc	32.2ft	0.4fc	32.2ft	0.4fc	32.2ft

At 45° Setting



POWER	15W		22W		26W		30W		33W	
DISTANCE	FOOT CANDLES	BEAM WIDTH	FOOT CANDLES	BEAM WIDTH	FOOT CANDLES	BEAM WIDTH	FOOT CANDLES	BEAM WIDTH	FOOT CANDLES	BEAM WIDTH
4ft	16.2fc	3.3ft	29.9fc	3.3ft	46.2fc	3.3ft	57.0fc	3.3ft	62.5fc	3.3ft
8ft	4.1fc	6.6ft	7.5fc	6.6ft	11.5fc	6.6ft	14.3fc	6.6ft	15.6fc	6.6ft
12ft	1.8fc	9.9ft	3.3fc	9.9ft	5.1fc	9.9ft	6.3fc	9.9ft	6.9fc	9.9ft
16ft	1.0fc	13.3ft	1.9fc	13.3ft	2.9fc	13.3ft	3.6fc	13.3ft	3.9fc	13.3ft
24ft	0.5fc	19.9ft	0.8fc	19.9ft	1.3fc	19.9ft	1.6fc	19.9ft	1.7fc	19.9ft
32ft	0.3fc	26.5ft	0.5fc	26.5ft	0.7fc	26.5ft	0.9fc	26.5ft	1.0fc	26.5ft
40ft	0.2fc	33.1ft	0.3fc	33.1ft	0.5fc	33.1ft	0.6fc	33.1ft	0.6fc	33.1ft
48ft	0.1fc	39.8ft	0.2fc	39.8ft	0.3fc	39.8ft	0.4fc	39.8ft	0.4fc	39.8ft
60ft	0.1fc	49.7ft	0.1fc	49.7ft	0.2fc	49.7ft	0.3fc	49.7ft	0.3fc	49.7ft

At 60° Setting



POWER	15W		22W		26W		30W		33W	
DISTANCE	FOOT CANDLES	BEAM WIDTH	FOOT CANDLES	BEAM WIDTH	FOOT CANDLES	BEAM WIDTH	FOOT CANDLES	BEAM WIDTH	FOOT CANDLES	BEAM WIDTH
4ft	10.6fc	4.6ft	19.5fc	4.6ft	30.1fc	4.6ft	37.1fc	4.6ft	40.7fc	4.6ft
8ft	2.6fc	9.2ft	4.9fc	9.2ft	7.5fc	9.2ft	9.3fc	9.2ft	10.2fc	9.2ft
12ft	1.2fc	13.9ft	2.2fc	13.9ft	3.3fc	13.9ft	4.1fc	13.9ft	4.5fc	13.9ft
16ft	0.7fc	18.5ft	1.2fc	18.5ft	1.9fc	18.5ft	2.3fc	18.5ft	2.5fc	18.5ft
24ft	0.3fc	27.7ft	0.5fc	27.7ft	0.8fc	27.7ft	1.0fc	27.7ft	1.1fc	27.7ft
32ft	0.2fc	37.0ft	0.3fc	37.0ft	0.5fc	37.0ft	0.6fc	37.0ft	0.6fc	37.0ft
40ft	0.1fc	46.2ft	0.2fc	46.2ft	0.3fc	46.2ft	0.4fc	46.2ft	0.4fc	46.2ft
48ft	0.1fc	55.4ft	0.1fc	55.4ft	0.2fc	55.4ft	0.3fc	55.4ft	0.3fc	55.4ft
60ft	0.0fc	69.3ft	0.1fc	69.3ft	0.1fc	69.3ft	0.2fc	69.3ft	0.2fc	69.3ft

HARDSCAPE PHOTOMETRICS

Mounting Height	Distance from Fixture				
	0	1'	2'	3'	4'
12"	12.73fc	2.88fc	0.42fc	0.09fc	0.03fc
24"	3.16fc	1.95fc	0.73fc	0.26fc	0.10fc
36"	1.39fc	1.11fc	0.65fc	0.33fc	0.16fc

Mounting Height	Distance from Fixture				
	0	1'	2'	3'	4'
12"	36.23fc	8.55fc	1.21fc	0.28fc	0.09fc
24"	9.29fc	5.76fc	2.14fc	0.75fc	0.30fc
36"	4.18fc	3.34fc	1.86fc	0.93fc	0.47fc

Mounting Height	Distance from Fixture				
	0	1'	2'	3'	4'
12"	64.85fc	15.61fc	2.42fc	0.57fc	0.19fc
24"	16.35fc	10.31fc	3.90fc	1.49fc	0.61fc
36"	7.25fc	5.85fc	3.44fc	1.77fc	0.91fc

Mounting Height	Distance from Fixture				
	0	1'	2'	3'	4'
12"	90.67fc	22.67fc	3.34fc	0.76fc	0.24fc
24"	23.13fc	14.68fc	5.57fc	2.04fc	0.82fc
36"	10.31fc	8.36fc	4.83fc	2.42fc	1.21fc

DECK & PATIO PHOTOMETRICS

Mounting Height	Distance from Fixture						
	0	0.5'	1'	2'	3'	4'	5'
6"	6.79fc	82fc	2.65fc	0.15fc	0.03fc	0.01fc	0.01fc
12"	15fc	39fc	9.9fc	0.42fc	0.09fc	0.03fc	0.02fc
30"	5.79fc	7.21fc	6.35fc	2.17fc	0.43fc	0.14fc	0.06fc

Mounting Height	Distance from Fixture						
	0	0.5'	1'	2'	3'	4'	5'
6"	16fc	74fc	0.92fc	0.04fc	0.01fc	-	-
12"	21fc	38fc	7.29fc	0.18fc	0.03fc	0.01fc	-
30"	5.86fc	7.2fc	5.97fc	1.85fc	0.24fc	0.07fc	0.03fc

Mounting Height	Distance from Fixture						
	0	0.5'	1'	2'	3'	4'	5'
6"	15fc	117fc	1.6fc	0.11fc	0.03fc	0.01fc	0.01fc
12"	15fc	43fc	19fc	0.26fc	0.07fc	0.03fc	0.01fc
30"	5.1fc	7.22fc	7fc	3.95fc	0.49fc	0.09fc	0.04fc

Mounting Height	Distance from Fixture						
	0	0.5'	1'	2'	3'	4'	5'
6"	96.66fc	24.3fc	11.16fc	0.95fc	0.08fc	0.01fc	0.01fc
12"	22.36fc	19.17fc	11.3fc	3.23fc	0.99fc	0.47fc	0.3fc
30"	3.8fc	3.6fc	3.36fc	2.34fc	1.52fc	1.04fc	0.77fc

Index

#	
12V RECTANGULAR STEP & WALL LIGHTS	126 / 127
12V & 120V RECTANGULAR STEP & WALL LIGHTS	128 / 129
12V MAGNETIC TRANSFORMER	150
12VAC OUTDOOR	130 / 131
24VDC OUTDOOR	132 / 133
24VDC OUTDOOR PRO+	134 / 135
24VDC OUTDOOR RGBWW	136 / 137
1" RECESSED IN-GROUNDS + INDICATORS	62
2" INDICATORS (COLORSCAPING)	30 / 31
2" RECESSED IN-GROUNDS + INDICATORS	63
2" SUBMERSIBLE, IN-GROUND	65
3" IN-GROUND	59
A	
ACCENT	47
ACCENT (COLORSCAPING)	6
ACCESSORIES	150 / 151 / 152
ACCESSORIES (COLORSCAPING)	40 / 41
ADJUSTABLE BEAM WALL WASH	54 / 55
ALTAR	103
AREA	86
ARCHETYPE (BOLLARD)	116
ARCHETYPE (PENDANT)	119
ARCHETYPE (POST MOUNT)	119
ARCHETYPE (WALL SCONCE)	118
B	
BALANCE (COLORSCAPING)	18
BALANCE (DOUBLE)	91
BALANCE (SINGLE)	90
BROUGH	76
C	
CANOPY	83
CHAMBER (BOLLARD)	112
CHAMBER (PENDANT)	115
CHAMBER (POST MOUNT)	115
CHAMBER (WALL SCONCE)	114
CIRKEL	151
CONE	151
CYLINDER WALL MOUNT	70
CYLINDER WALL MOUNT (COLORSCAPING)	25
CUBICAL	104
D	
DECIBLE	98
DECK & PATIO	120
DECK & PATIO (COLORSCAPING)	37
E	
ECLIPSE	94
ENDURANCE (BRICK LIGHTS)	124
ENDURANCE (LED WALL PACK)	142
ENDURANCE SPOT DOUBLE (FLOOD LIGHTS)	143
ENDURANCE SPOT SINGLE (FLOOD LIGHTS)	143
ENDURANCE WALL MOUNTED SPOT (SINGLE & DOUBLE)	144 / 145
ENDURANCE WALL PACK (FIN & HAWK)	144
EVEN	100
G	
GRAND ACCENT	44
GRAND ACCENT (COLORSCAPING)	9
GRAND IN-GROUND	58
GRAND LEDGE	97
GATE	106
H	
HARDSCAPE	73
HARDSCAPE (COLORSCAPING)	26
HORNET	53
HYLINE	80
I	
IN-GROUND (COLORSCAPING)	14
INTERBEAM	50
INTERPATH	85
INVISILED®	132 / 133
L	
LANTERN	151
LEDGE	95
LEDGE (COLORSCAPING)	21
LINEAR PATH LIGHT	74
LINEAR PATH LIGHT (COLORSCAPING)	17
M	
MINI ACCENT	48
MINI ACCENT (PATH)	49
MINI WALL WASH	57
O	
OUTDOOR TRACK	138 / 139
P	
PASSAGE	99
POWER ACCENT (COLORSCAPING)	10
PLAYNE	151
Q	
QUAD	93
R	
RUBIX (DECORATIVE CEILING MOUNT)	146
RUBIX (DECORATIVE WALL MOUNT)	148
S	
SCOOP	109
SLIDE	88
SLOPE	87
SPOTT	151
STAFF	151
STANDUP	79
STEP LIGHTS	122
STEP LIGHT (COLORSCAPING)	29
SURFACE MOUNT INDICATOR	60
SURFACE MOUNT STEP LIGHTS	125
T	
TAPE LIGHT (COLORSCAPING)	38 / 39
TIKI	82
TIKI (COLORSCAPING)	22
TOWER	111
TREE LIGHTS	69
TUBE (DECORATIVE CEILING MOUNT)	147
TUBE (DECORATIVE PENDANT)	147
TUBE (DECORATIVE WALL MOUNT)	149
U	
UNDERWATER SPOT	69
UNDERWATER SPOT NB	34
UNDERWATER SPOT SS	33
W	
WALL WASH	56
WALL WASH (COLORSCAPING)	13
X	
X-10 TRACK HEAD	138 / 139

NOTES

NOTES

Headquarters

Tel: 800.526.2588
Fax: 800.526.2585

44 Harbor Park Dr
Port Washington, NY 11050

South East

1600 Distribution Ct
Lithia Springs, GA 30122

Central

1700 South J Elmer Freeway
Suite 100
Cedar Hill, TX 75104

West

1750 S Archibald Ave
Ontario, CA 91761

Consult our manufacturing facility to take advantage of our custom capabilities for large quantities. For up-to-date product specifications and assistance please visit waclighting.com or call **1-800-526-2588**

This catalog includes patented and patent-pending products or features. We will not hesitate to enforce our intellectual property rights through injunctive relief and seek further relief through damages if we have reason to believe the patents are being infringed.

© 2026 WAC Group

All rights reserved. This catalog is copyrighted and WAC Group reserves the right to use any and all measures available to it under the law against anyone who copies or derives from its copyrighted work.

WAC GROUP

TECHNOLOGY ILLUMINATED

WAC Lighting technology is protected by several patents and pending patent applications, including U.S. Patent Nos. 9,784,440, 10,190,757, 10,208,935, 10,323,832, 10,330,294, 10,465,888, 10,571,101, 10,598,358, 10,920,971, 10,928,045, 10,941,924, 10,962,209, 10,969,088, 10,989,401, 11,199,319, 11,274,816, 11,280,483, 11,408,597, 11,460,177, 11,686,459, 11,719,422, 11,940,135, 12,075,545, 12,477,642.

WAC Lighting will not hesitate to enforce its intellectual property rights through injunctive relief and seek further relief through damages if it has reason to believe its patents are being infringed.

Copyright © 2026 WAC Group. All rights reserved. This catalog is copyrighted and WAC Group will use all measures available to it under the law against anyone who copies or derives from its copyrighted work.

WAC Lighting retains the right to modify the design of its products at any time as part of the company's continuous improvement program. Please refer to our website for the latest product specifications.

800.526.2588 | [WACLIGHTING.COM/LANDSCAPE](https://www.waclighting.com/landscape) | [WACLIGHTING.COM/COLORSCAPING](https://www.waclighting.com/colorscaping)