

VISUAL COMFORT & CO.



LANDSCAPE COLLECTION

VISUAL COMFORT & Co.

LANDSCAPE COLLECTION

Our story has always been about the transformative power of lighting—how it illuminates, elevates, and brings spaces to life. At Visual Comfort & Co., we create lighting that inspires, blending design and creativity, craft and technology, style and performance to enrich every space, both indoors and out.

LANDSCAPE COLLECTION

Our Landscape Collection honors the natural beauty of outdoor spaces with timeless design and premium materials. Crafted with precision and intention, these fixtures seamlessly integrate into gardens, patios, and walkways, bringing warmth, connection, and refinement. By balancing form and function, we transform the outdoors into true extensions of the home.

We believe lighting is more than an accessory—it is the defining element of design. Our mission is to illuminate every environment with intention and brilliance, meeting the highest standards of style, quality, and performance.



4	PRODUCT INDEX
10	FEATURES & BENEFITS
28	DIRECTIONAL
44	PATH & AREA
70	IN-GRADE
110	HARDSCAPE
118	STEP LIGHTS
136	WALL & POST MOUNT
146	FLUSH MOUNT
152	ACCESSORIES

CONTENTS

DIRECTIONAL LIGHTING



CORA
MR11 LED

PG: 30 - 31



CORA 50° SHROUD
MR11 LED

PG: 32 - 33



MESA
INTEGRATED LED

PG: 34 - 35



SIERRA
MR16 LED

PG: 36 - 37



SIERRA 50° SHROUD
MR16 LED

PG: 38 - 39



TULE
INTEGRATED LED

PG: 40 - 41



TULE 50° SHROUD
INTEGRATED LED

PG: 42 - 43



ASCEND
G4 LED

PG: 46 - 47



BALSAM
G4 LED

PG: 48 - 49



PEAK
G4 LED

PG: 50 - 51



PEAK WIDE
G4 LED

PG: 52 - 53



PLATEAU
G4 LED

PG: 54 - 55



PLATEAU WIDE
G4 LED

PG: 56 - 57



SENTINEL SHALLOW
G4 LED

PG: 58 - 59



SENTINEL DEEP
G4 LED

PG: 60 - 61



ACADIA
INTEGRATED LED

PG: 62 - 63



ACADIA EDGE
INTEGRATED LED

PG: 64 - 65



KENNETT
INTEGRATED LED

PG: 66 - 67



RAYUL
INTEGRATED LED

PG: 68 - 69

IN-GRADE LIGHTING



**DELPHINI MICRO FIXED
WITH FLANGE**
INTEGRATED LED
PG: 72 - 73



**SHAVER 16 FIXED
OPEN FLAT**
MR16 LED
PG: 74 - 75



**SHAVER 11 FIXED
OPEN FLAT**
MR11 LED
PG: 76 - 77



**SHAVER 16 FIXED OPEN
IN-GRADE**
MR16 LED
PG: 78 - 79



**SHAVER 11 FIXED OPEN
IN-GRADE**
MR11 LED
PG: 80 - 81



**SHAVER 16 FIXED
WITH SHROUD**
MR16 LED
PG: 82 - 83



**SHAVER 11 FIXED
WITH SHROUD**
MR11 LED
PG: 84 - 85



**SHAVER 16 FIXED
WITH GRILL GUARD**
MR16 LED
PG: 86 - 87



**SHAVER 11 FIXED
WITH GRILL GUARD**
MR11 LED
PG: 88 - 89



**SHAVER 16 FIXED
90° APERTURE**
MR16 LED
PG: 90 - 91



**SHAVER 11 FIXED
90° APERTURE**
MR11 LED
PG: 92 - 93



**SHAVER 16 FIXED OPPOSITE
90° APERTURE**
MR16 LED
PG: 94 - 95



**SHAVER 11 FIXED OPPOSITE
90° APERTURE**
MR11 LED
PG: 96 - 97



**SHAVER 16 FIXED
180° APERTURE**
MR16 LED
PG: 98 - 99



**SHAVER 11 FIXED
180° APERTURE**
MR11 LED
PG: 100 - 101



**SHAVER 16 FIXED
270° APERTURE**
MR16 LED
PG: 102 - 103



**SHAVER 11 FIXED
270° APERTURE**
MR11 LED
PG: 104 - 105



**SHAVER 16 FIXED
360° APERTURE**
MR16 LED
PG: 106 - 107



**SHAVER 11 FIXED
360° APERTURE**
MR11 LED
PG: 108 - 109

HARDSCAPE LIGHTING



BROOKS 6"
INTEGRATED LED

PG: 112 - 113



BROOKS 12"
INTEGRATED LED

PG: 114 - 115



BROOKS 18"
INTEGRATED LED

PG: 116 - 117

STEP LIGHTING



K Aidan SQUARE APERTURE
12V / 120V

PG: 120 - 123



K Aidan HEX APERTURE
12V / 120V

PG: 124 - 127



K Aidan ROUND APERTURE
12V / 120V

PG: 128 - 131



K Aidan TRIANGLE APERTURE
12V / 120V

PG: 132 - 135

WALL & POST MOUNT LIGHTING



SENTINEL SHALLOW
G4 LED

PG: 138 - 139



SENTINEL DEEP
G4 LED

PG: 140 - 141



BALSAM
G4 LED

PG: 142 - 143



PLATEAU WIDE
G4 LED

PG: 144 - 145

FLUSH MOUNT LIGHTING



MAXSON SQUARE
MR16 LED

PG: 148 - 149



MAXSON ROUND
MR16 LED

PG: 150 - 151

MOUNTING OPTIONS



HEAVY-DUTY STAKE

PG: 155

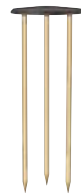

12" TRIDENT STAKE

PG: 156



**ARBOR TREE MOUNT
SCREW-IN**

PG: 157



ARBOR TREE & SURFACE MOUNT

PG: 158



ARBOR BUNGEE STRAP

PG: 159



ARBOR GUTTER MOUNT

PG: 160



DECK/SURFACE MOUNT

PG: 161



FEATURES & BENEFITS



LIVING FINISHES

PATINA

Our landscape lighting products celebrate the inherent beauty of brass and copper—materials chosen not only for their performance but for their ability to age gracefully. To achieve a bronze finish, we expertly age the brass, allowing each fixture to develop a rich, unique patina over time. This natural evolution blends authentic design with enduring craftsmanship, creating lighting that becomes more beautiful with every passing season.



BALSAM IN BRONZE

With its deep, rich tones, bronze finish ages gracefully, developing a distinctive patina that adds depth and character to outdoor spaces.



PEAK IN HAND-RUBBED ANTIQUE BRASS

This warm, golden finish is carefully hand-rubbed to perfection, evolving over time into a lustrous patina that exudes timeless elegance.



ASCEND IN COPPER

Naturally radiant and versatile, natural copper matures with a striking patina that enhances its charm and complements any landscape.

NATURAL MATERIAL

Our landscape lighting products feature the natural beauty of travertine, available in dark and natural tones. Its unique texture and color variations add depth and character to outdoor spaces. Durable and versatile, travertine complements a range of landscape designs with a clean, natural look.



KENNETT

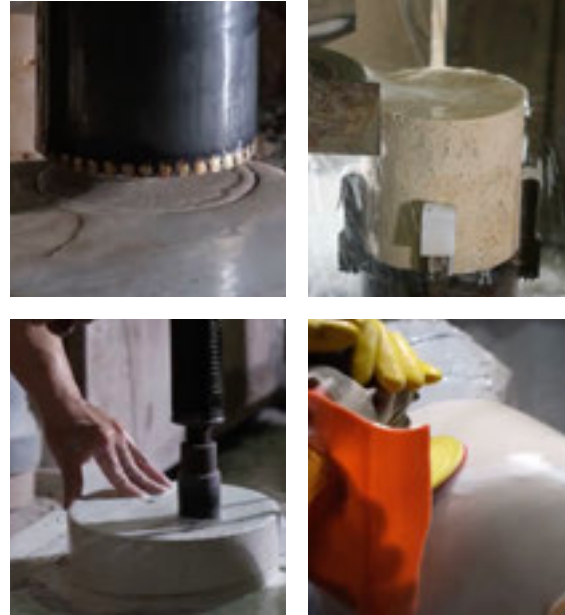

DARK TRAVERTINE



LIGHT TRAVERTINE

BUILT TO LAST

DIRECTIONAL SERIES

Engineered for versatility, the Cora and Sierra series are ideal for floodlighting, moonlighting, grazing, and accentuating architectural features and landscapes. Designed for dependable performance and effortless maintenance, it brings a refined detail to any outdoor setting.



SIERRA DIRECTIONAL SPOT WITH 50° CUT-OFF SHROUD

PRESSED GLASS LENS

Protects the internal components by preventing water and debris accumulation. The shrouded version features a slight angle to ensure effective drainage.

COIL SPRING WITH LAMP-CENTERING RING

Ensures the lamp remains perfectly aligned with the fixture aperture while securely holding any optional lenses in place with a coil spring.

CERAMIC BI-PIN SOCKET

Ensures a secure, reliable connection with the MR bi-pin lamp using spring-backed electrical contacts. Features a field-replaceable socket assembly for easy maintenance.

DOUBLE O-RING GASKET

Offers IP65-rated protection, shielding the lamp and socket from dust and moisture.

+/- 117° RANGE PIVOT ASSEMBLY

Designed for precision and durability, this adjustable mechanism offers a smooth, stable angling range—extending up to 117 degrees for perfectly directed illumination.

**IN-GRADE WELL
LIGHTS SERIES**

Crafted for seamless integration, the Delphini and Shaver series deliver discreet, low-profile illumination that enhances both turf and hardscape areas. Designed with precision and durability, these fixtures provide reliable performance while adding a touch of luxury to outdoor spaces.

BRASS OR COPPER FORGED MATERIAL

Built from premium materials for exceptional durability and timeless elegance.

COIL SPRING WITH LAMP-CENTERING RING

The coil spring ensures precise lamp alignment and secures optional lenses for optimal performance.

CERAMIC BI-PIN SOCKET

Features spring-backed electrical contacts for a tight, secure connection to the MR bi-pin lamp while allowing for easy field replacement.

FULLY SEALED ASSEMBLY

Provides robust protection against moisture and debris, ensuring long-lasting reliability.



SHAVER 16 FIXED 180° APERTURE

BUILT TO LAST

ACADIA EDGE

This elegantly crafted pathway light offers exceptional durability with a sleek, modern design. Engineered with an integrated LED module, it provides effective forward-throw light distribution while minimizing light spill. Its robust construction ensures lasting performance, making it an ideal choice for illuminating walkways with precision.



ACADIA EDGE

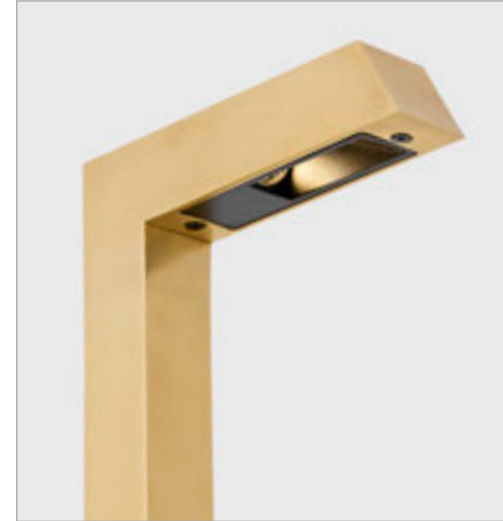

FIELD SERVICEABLE LED MODULE

Featuring a field-serviceable LED module, this pathway light ensures easy maintenance and long-lasting performance, allowing for quick updates or repairs without compromising its elegant design.



ADJUSTABILITY

AESTHETIC CONTROL

Our directional lights offer superior adjustability, with heads that rotate up to 234 degrees (+/- 117°) for precise illumination. Designed for both installers and end users, the pivot mechanism features a secure locking system, ensuring stability and flexibility. This system expands downlighting capabilities from elevated surfaces.

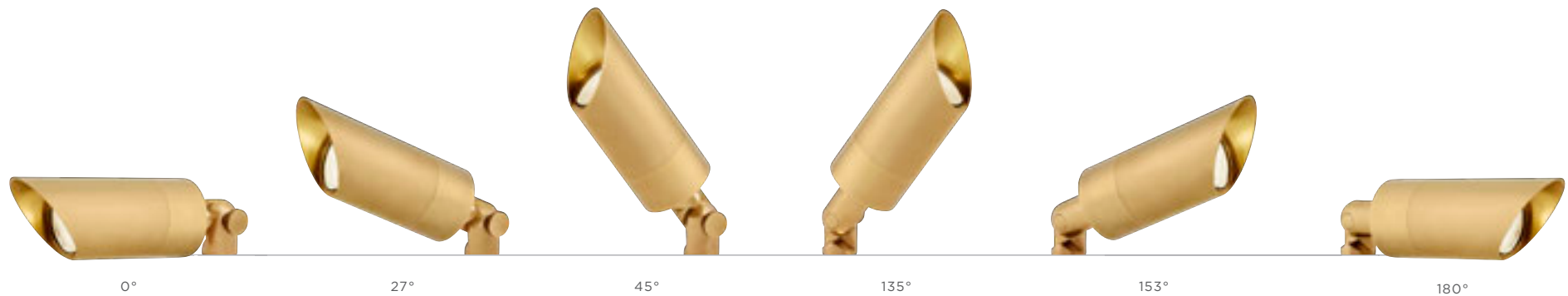

THUMB SCREW

Easily adjustable with no tools required, ensuring quick and secure installation.

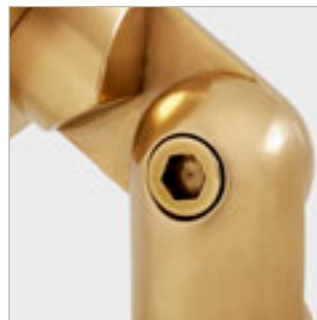

COUNTERSUNK SCREW

For professional installations, this optional feature replaces the standard thumb screw with an included socket head screw, maintaining a clean, streamlined aesthetic while ensuring secure mounting.



INTERLOCK MECHANISM

Our directional lights feature a precision-engineered rotation mechanism with cast notches for superior durability and wear resistance. Designed for longevity, it also includes a threaded stud that can be easily replaced in the field.



PAINTED SURFACE

INNER-WHITE DOME

Our pathway light shades are painted white on the inside to increase light reflection, ensuring maximum efficiency and uniform illumination.



ASCEND



BALSAM



PEAK



PEAK WIDE



PLATEAU



PLATEAU WIDE



SENTINEL SHALLOW



SENTINEL DEEP



CRAFTED LUMINESCENCE

FLUTED GLASS

Fluted glass diffuses light to create a soft, even glow, while adding protection and enhancing visual comfort.

CUT-OFF REFLECTOR

Designed to redirect light precisely where needed, the cut-off reflector helps control light distribution and reduce light pollution, ensuring targeted and efficient illumination. This accessory is ideal for illuminating pathways while preventing unwanted light spill onto surrounding areas.



GLARE CONTROL

HEX LOUVER

Hex louvers, available in a variety of sizes and shapes to fit different fixtures, are designed to reduce glare for a more comfortable and defined illumination.



TULE MICRO
DIRECTIONAL SPOT



TULE HEX LOUVER



CORA DIRECTIONAL
SPOT LIGHT



MR11 ROUND HEX LOUVER



SIERRA DIRECTIONAL
SPOT LIGHT



MR16 ROUND HEX LOUVER



SHAVER 11 FIXED OPEN FLAT



MR11 ROUND IN-GRADE
HEX LOUVER



SHAVER 16 FIXED OPEN FLAT



MR16 ROUND IN-GRADE
HEX LOUVER



MAXSON SQUARE
FLUSH MOUNT

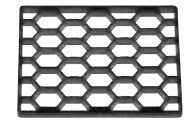

MR16 SQUARE HEX LOUVER



MESA DIRECTIONAL SPOT LIGHT



MESA HEX LOUVER

OPTICAL LENS FILTER

COLOR LENSES

Acrylic-colored lenses, available in red, green, and blue, offer a creative way to enhance landscape lighting. These filters add depth and mood to outdoor spaces, highlighting natural elements with vibrant, dynamic effects.



RED LENS

The red lens adds warmth and intensity, accentuating deep hues in foliage like crimson leaves or rich earthy tones. It's ideal for emphasizing warm color palettes in late summer or autumn landscapes, creating a striking and dramatic effect.

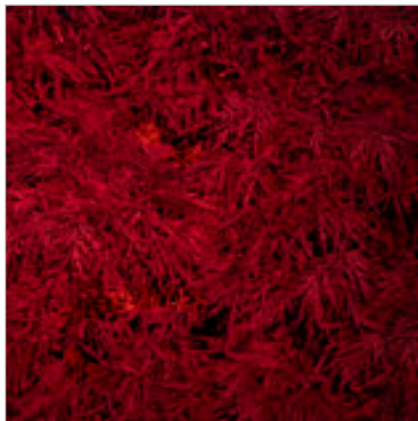

RED LENS ON RED MAPLE



GREEN LENS

The green lens enhances the vibrancy of natural greens, making it ideal for highlighting lush foliage, ground cover, and garden beds. It's especially effective in spring and summer when landscapes are at their most verdant and alive.

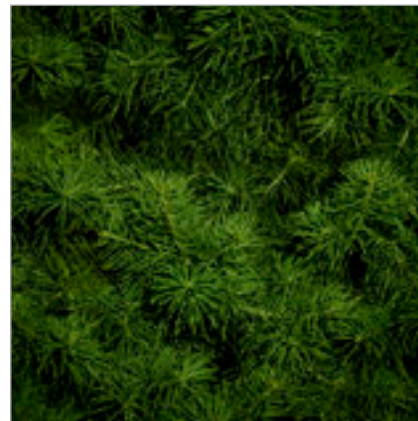

GREEN LENS ON EVERGREEN



BLUE LENS

The blue lens creates a cool, soothing glow, perfect for illuminating water features or accentuating silvery tones in plants like blue spruces or sage. It works beautifully in summer to evoke a tranquil and refreshing atmosphere.



BLUE LENS ON BLUE SPRUCE

LENS DIFFUSERS

Lens diffusers are essential for landscape lighting, offering control and customization of light distribution. By softening, focusing, or spreading light, they allow for tailored beams that enhance outdoor spaces, reduce glare, and highlight specific features with precision.



DIFFUSER SPREAD LENS

The diffuser spread lens softens and broadens light output, ideal for evenly illuminating larger areas like garden beds, walkways, or low-level foliage.



LINEAR SPREAD LENS

The linear spread lens creates an elongated beam pattern, making it perfect for lighting pathways, retaining walls, or other linear landscape features with uniform coverage.



SOLITE SOFT FOCUS LENS

The solite soft focus lens delivers a subtle, diffused light that reduces harsh shadows, making it ideal for accenting delicate features like ornamental plants or statues with a gentle glow.



SANDBLASTED LENS

The sandblasted lens provides an even distribution, ideal for achieving a soft, ambient light that is perfect for creating a calming atmosphere around seating areas or patios.

DURABLE INSTALLATION

HEAVY-DUTY STAKE

Premium heavy-duty stake designed for secure, long-lasting fixture installation. It provides a stable foundation to keep lighting perfectly positioned in any landscape. Built with high-quality materials and thoughtful engineering, it offers durability and ease of use.



OVER-MOLDED THREADED BRASS INSERT

Features an over-molded threaded brass insert for a strong and secure connection, ensuring your fixture stays firmly in place.

REINFORCED SURFACES

Reinforced surfaces add strength and durability, enabling the stake to withstand various ground conditions while maintaining stability.

SLOTTED DESIGN

The slotted design allows the cord to exit through the side, simplifying installation and protecting the wiring for long-term reliability.

STABLE 13" LENGTH

With a stable 13" overall length, the stake ensures deep, secure placement in the ground, providing enhanced support and preventing shifting over time.

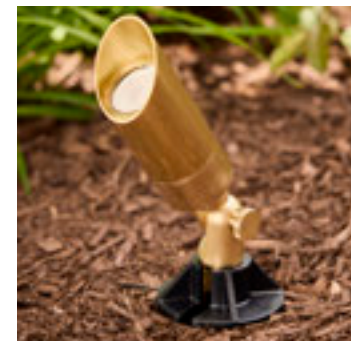

SIERRA DIRECTIONAL SPOT WITH 50° CUT-OFF SHROUD AND HEAVY-DUTY STAKE

MOUNTING OPTIONS

ARBOR TREE MOUNT SCREW-IN

Arbor tree and surface mounts offer flexible options for illuminating landscapes and trees from elevated positions. By securely attaching fixtures to trunks, branches, or surfaces, these mounts create dynamic lighting effects such as grazing, shadowing and moonlighting. Ideal for highlighting architectural features or casting soft, ambient light over large areas, they provide precision placement with minimal disruption to the surrounding landscape.



SIERRA DIRECTIONAL SPOT WITH 50°
CUT-OFF SHROUD & ARBOR TREE MOUNT SCREW-IN

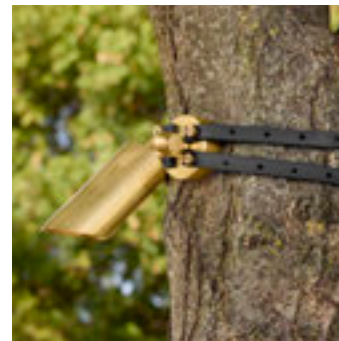

ARBOR TREE BUNGEE

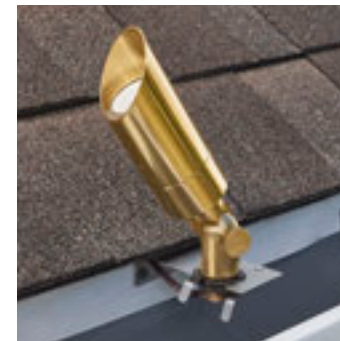

ARBOR GUTTER MOUNT

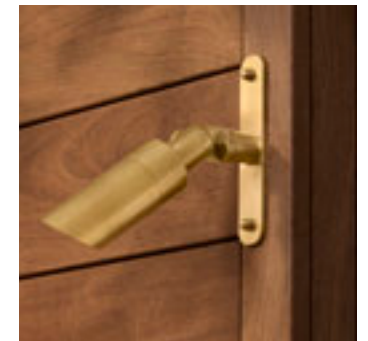

ARBOR TREE & SURFACE MOUNT

DIRECTIONAL LIGHTING



Cora

DIRECTIONAL SPOT

DESIGNER: SEAN LAVIN

The Cora directional spotlight features a sleek cylindrical design with a fully sealed, domed glass lens for water dispersion. Its adjustable and lockable head rotate up to 234 degrees (+/- 117°) for enhanced aiming. Engineered for durability, it includes a field-replaceable ceramic socket assembly and IP65-rated protection, ensuring reliable performance in outdoor environments. Cora is compatible with various mounting accessories to provide installation flexibility.



BRONZE



HAND-RUBBED ANTIQUE BRASS



NATURAL COPPER

SPECIFICATIONS

DIMENSIONS	
Fixture Height	4.7" / 119 mm
Fixture Width	1.8" / 46 mm
MATERIAL	
Material	Brass or Copper
Finish	Bronze, Hand-Rubbed Antique Brass or Natural Copper
Weight	1.5 lb
SOCKET	
Assembly	Ceramic with spring-reinforced electrical connection
LAMPING	
Lamp Type	MR11 LED (Sold Separately)
Lumens	270
Watts	3W
Voltage	12V
Lead Wire	18 AWG, 36"
Dimming	MLV
CCT	2700K
Color Quality	90 CRI
Color Binning	3 Step
Field Serviceable LED	Yes
Operating Temperature	-30°C min -40°C max
LED Lifetime	25,000 Hours
OPTIONS	
Riser	Standard 1": 15", 18", 24"
Knuckle	Thumb Screw (Included), Countersunk Screw (Included)
Mounting	Heavy-Duty Stake, Deck/Surface Mount, Arbor Bungee Strap, Arbor Tree & Surface Mount, Arbor Tree Mount Screw-In, Arbor Gutter Mount, 12" Trident Spike
Optical Controls	Hex Louver (Included), Colored Lenses: Blue, Green, Red, Optical Lenses: Diffuser Spread, Linear Spread, Solite Soft Focus, Sandblasted
WARRANTY	
Lifetime warranty on manufacturer defects in the construction, but normal warranty applies for bulbs, integrated LEDs and living finishes.	

DIMENSIONS

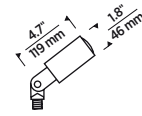

MOUNTING & ACCESSORIES



HEAVY-DUTY STAKE
SL659



DECK/SURFACE MOUNT
SL668HAB,
SL668BZ,
SL668NC



ARBOR BUNGEE STRAP
SL666BZ,
SL666HAB,
SL666NC



ARBOR TREE & SURFACE MOUNT
SL664BZ,
SL664HAB,
SL664NC



ARBOR TREE MOUNT SCREW-IN
SL665BZ,
SL665HAB,
SL665NC



ARBOR GUTTER MOUNT
SL667



12" TRIDENT SPIKE
SL6122BZ
SL6122HAB,
SL6122NC



HEX LOUVER (INCLUDED)
SL673

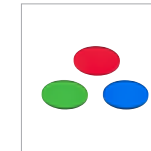

COLORED LENS
SL671BL,
SL671GR,
SL671RD

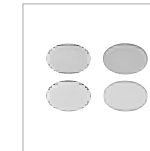

LENS DIFFUSERS
SL6106DF,
SL6106LL,
SL6106SF,
SL6106SB

ORDERING INFORMATION

PRODUCT	RISER HEIGHT	FINISH	LAMP	MOUNTING	LENS
SL624 CORA DIRECTIONAL SPOT	NR NO RISER	BZ BRONZE	NB NO LAMP	NM NO MOUNT	NL NO LENS
	11 15" RISER (1" DIA.)	HAB HAND-RUBBED ANTIQUE BRASS	B5 LED LAMP MR11 3W 36° 90 CRI 2700K	M1 HEAVY-DUTY STAKE	BL BLUE
	12 18" RISER (1" DIA.)	NC NATURAL COPPER	B6 LED LAMP MR11 3W 60° 90 CRI 2700K	M2 SURFACE	GR GREEN
	13 24" RISER (1" DIA.)			M4 BUNGEE	RD RED
				M5 TREE SURFACE	DF DIFFUSER SPREAD LENS
				M6 TREE SCREW-IN	LL LINEAR SPREAD LENS
				M7 GUTTER MOUNT	SF SOLITE SOFT FOCUS LENS
				M10 12" TRIDENT SPIKE	SB SANDBLASTED LENS

HEX LOUVER INCLUDED.



Cora

DIRECTIONAL SPOTLIGHT WITH 50° CUT-OFF SHROUD

DESIGNER: SEAN LAVIN

Cora directional spotlight features a sleek cylindrical design with a 50° cut-off shroud, delivering precise, glare-reducing illumination. Its adjustable and lockable head rotate up to 234 degrees (+/- 117°) for enhanced aiming. The unit is IP65-rated ensured by fully sealed dome glass and includes a field-replaceable ceramic socket assembly for reliable performance in outdoor environments. Cora is compatible with various mounting accessories to provide installation flexibility.



BRONZE



HAND-RUBBED ANTIQUE BRASS



NATURAL COPPER

SPECIFICATIONS

DIMENSIONS	
Fixture Height	6.2" / 157 mm
Fixture Width	1.8" / 46 mm
MATERIAL	
Material	Brass or Copper
Finish	Bronze, Hand-Rubbed Antique Brass or Natural Copper
Weight	1.7 lb
SOCKET	
Assembly	Ceramic with spring-reinforced electrical connection
LAMPING	
Lamp Type	MR11 LED (Sold Separately)
Lumens	270
Watts	3W
Voltage	12V
Lead Wire	18 AWG, 36"
Dimming	MLV
CCT	2700K
Color Quality	90 CRI
Color Binning	3 Step
Field Serviceable LED	Yes
Operating Temperature	-30°C min -40°C max
LED Lifetime	25,000 Hours
OPTIONS	
Riser	Standard 1": 15", 18", 24"
Knuckle	Thumb Screw (Included), Countersunk Screw (Included)
Mounting	Heavy-Duty Stake, Deck/Surface Mount, Arbor Bungee Strap, Arbor Tree & Surface Mount, Arbor Tree Mount Screw-In, Arbor Gutter Mount, 12" Trident Spike
Optical Controls	Hex Louver (Included), Colored Lenses: Blue, Green, Red, Optical Lenses: Diffuser Spread, Linear Spread, Solite Soft Focus, Sandblasted
WARRANTY	
Lifetime warranty on manufacturer defects in the construction, but normal warranty applies for bulbs, integrated LEDs and living finishes.	

DIMENSIONS

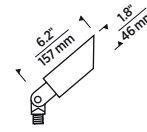

MOUNTING & ACCESSORIES



HEAVY-DUTY STAKE
SL659



DECK/SURFACE MOUNT
SL668HAB,
SL668BZ,
SL668NC



ARBOR BUNGEE STRAP
SL666BZ,
SL666HAB,
SL666NC



ARBOR TREE & SURFACE MOUNT
SL664BZ,
SL664HAB,
SL664NC



ARBOR TREE MOUNT SCREW-IN
SL665BZ,
SL665HAB,
SL665NC



ARBOR GUTTER MOUNT
SL667



12" TRIDENT SPIKE
SL6122BZ,
SL6122HAB,
SL6122NC

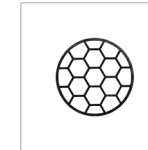

HEX LOUVER (INCLUDED)
SL673

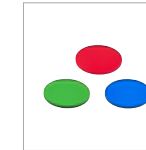

COLORED LENS
SL671BL,
SL671GR,
SL671RD

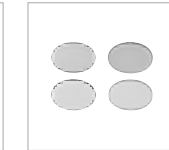

LENS DIFFUSERS
SL6106DF,
SL6106LL,
SL6106SF,
SL6106SB

ORDERING INFORMATION

PRODUCT	RISER HEIGHT	FINISH	LAMP	MOUNTING	LENS
SL625 CORA DIRECTIONAL SPOT WITH 50° CUT-OFF SHROUD	NR NO RISER	BZ BRONZE	NB NO LAMP	NM NO MOUNT	NL NO LENS
	11 15" RISER (1" DIA.)	HAB HAND-RUBBED ANTIQUE BRASS	B5 LED LAMP MR11 3W 36° 90 CRI 2700K	M1 HEAVY-DUTY STAKE	BL BLUE
	12 18" RISER (1" DIA.)	NC NATURAL COPPER	B6 LED LAMP MR11 3W 60° 90 CRI 2700K	M2 SURFACE	GR GREEN
	13 24" RISER (1" DIA.)			M4 BUNGEE	RD RED
				M5 TREE SURFACE	DF DIFFUSER SPREAD LENS
				M6 TREE SCREW-IN	LL LINEAR SPREAD LENS
				M7 GUTTER MOUNT	SF SOLITE SOFT FOCUS LENS
				M10 12" TRIDENT STAKE	SB SANDBLASTED LENS

HEX LOUVER INCLUDED.



Mesa

DIRECTIONAL WALL WASH

DESIGNER: SEAN LAVIN

The Mesa Directional Wall Wash has a rectangular form factor with a cut-off shroud for a directed, glare reducing illumination. It features an integrated LED module light engine with 3 field selectable power levels. Its adjustable and lockable head rotate up to 234 degrees (+/- 117°) for enhanced aiming. The unit is IP65-rated ensured by fully sealed front glass which can be coupled with multiple optical accessories for reliable and versatile performance in outdoor environments. Mesa is also compatible with various mounting accessories to provide installation flexibility.



BRONZE



HAND-RUBBED ANTIQUE BRASS



NATURAL COPPER

SPECIFICATIONS

DIMENSIONS	
Fixture Height	2" / 51 mm
Fixture Width	4.5" / 114 mm
MATERIAL	
Material	Brass or Copper
Finish	Bronze, Hand-Rubbed Antique Brass or Natural Copper
Weight	3.2 lb
LAMPING	
Lamp Type	Integrated LED
Lumens	220, 350, 470
Watts	Selectable: 3W, 5W, 7W
Voltage	12V
Lead Wire	18 AWG, 36"
Dimming	MLV
CCT	2700K
Color Quality	90 CRI
Color Binning	3 Step
Field Serviceable LED	Yes
Operating Temperature	-30°C min -40°C max
LED Lifetime	36,000 Hours
OPTIONS	
Riser	Standard 1": 15", 18", 24"
Knuckle	Thumb Screw (Included), Countersunk Screw (Included)
Mounting	Heavy-Duty Stake, Deck/Surface Mount, Arbor Bungee Strap, Arbor Tree & Surface Mount, Arbor Tree Mount Screw-In, Arbor Gutter Mount, 12" Trident Spike
Optical Controls	Hex Louver (Included), Optical Lenses: Wall Wash Horizontal Spread, Wall Wash Vertical Spread
WARRANTY	
Lifetime warranty on manufacturer defects in the construction, but normal warranty applies for bulbs, integrated LEDs and living finishes.	

DIMENSIONS

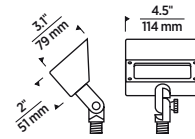

MOUNTING & ACCESSORIES



HEAVY-DUTY STAKE
SL659



DECK/SURFACE MOUNT
SL668HAB,
SL668BZ,
SL668NC



ARBOR BUNGEE STRAP
SL666BZ,
SL666HAB,
SL666NC



ARBOR TREE & SURFACE MOUNT
SL664BZ,
SL664HAB,
SL664NC



ARBOR TREE MOUNT SCREW-IN
SL665BZ,
SL665HAB,
SL665NC



ARBOR GUTTER MOUNT
SL667



12" TRIDENT SPIKE
SL6122BZ,
SL6122HAB,
SL6122NC

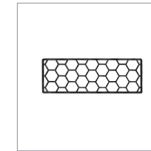

HEX LOUVER (INCLUDED)
SL677



WALL WASH HORIZONTAL SPREAD
SL678



WALL WASH VERTICAL SPREAD
SL679

ORDERING INFORMATION

PRODUCT	RISER HEIGHT	FINISH	LAMP	MOUNTING
SL628 MESA DIRECTIONAL WALL WASH	NR NO RISER	BZ BRONZE	L1 INTEGRATED LED SELECTABLE 3W, 5W, 7W 90 CRI 2700K	NM NO MOUNT
	11 15" RISER (1" DIA.)	HAB HAND-RUBBED ANTIQUE BRASS		M1 HEAVY-DUTY STAKE
	12 18" RISER (1" DIA.)	NC NATURAL COPPER		M2 SURFACE
	13 24" RISER (1" DIA.)			M4 BUNGEE
			M5 TREE SURFACE	
			M6 TREE SCREW-IN	
			M7 GUTTER MOUNT	
			M10 12" TRIDENT SPIKE	

HEX LOUVER INCLUDED.



Sierra

DIRECTIONAL SPOT

DESIGNER: SEAN LAVIN

The Sierra directional spotlight features a sleek cylindrical design with a fully sealed, domed glass lens for water dispersion. Its adjustable and lockable head rotate up to 234 degrees (+/- 117°) for enhanced aiming. Engineered for durability, it includes a field-replaceable ceramic socket assembly and IP65-rated protection, ensuring reliable performance in outdoor environments. Sierra is compatible with various mounting accessories to provide installation flexibility.



BRONZE



HAND-RUBBED ANTIQUE BRASS



NATURAL COPPER

SPECIFICATIONS

DIMENSIONS	
Fixture Height	7.3" / 185 mm
Fixture Width	2.4" / 61 mm
MATERIAL	
Material	Brass or Copper
Finish	Bronze, Hand-Rubbed Antique Brass or Natural Copper
Weight	2.5 lb
SOCKET	
Assembly	Ceramic with spring-reinforced electrical connection
LAMPING	
Lamp Type	MR16 LED (Sold Separately)
Lumens	495, 507
Watts	5W
Voltage	12V
Lead Wire	18 AWG, 36"
Dimming	MLV
CCT	2700K
Color Quality	90 CRI
Color Binning	3 Step
Field Serviceable LED	Yes
Operating Temperature	-30°C min -40°C max
LED Lifetime	36,000 Hours
OPTIONS	
Riser	Standard 1": 15", 18", 24"
Knuckle	Thumb Screw (Included), Countersunk Screw (Included)
Mounting	Heavy-Duty Stake, Deck/Surface Mount, Arbor Bungee Strap, Arbor Tree & Surface Mount, Arbor Tree Mount Screw-In, Arbor Gutter Mount, 12" Trident Stake
Optical Controls	Hex Louver (Included), Colored Lenses: Blue, Green, Red, Optical Lenses: Diffuser Spread, Linear Spread, Solite Soft Focus, Sandblasted
WARRANTY	
Lifetime warranty on manufacturer defects in the construction, but normal warranty applies for bulbs, integrated LEDs and living finishes.	

DIMENSIONS

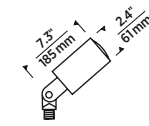

MOUNTING & ACCESSORIES



HEAVY-DUTY STAKE
SL659



DECK/SURFACE MOUNT
SL668HAB,
SL668BZ,
SL668NC



ARBOR BUNGEE STRAP
SL666BZ,
SL666HAB,
SL666NC



ARBOR TREE & SURFACE MOUNT
SL664BZ,
SL664HAB,
SL664NC



ARBOR TREE MOUNT SCREW-IN
SL665BZ,
SL665HAB,
SL665NC



ARBOR GUTTER MOUNT
SL667



12" TRIDENT SPIKE
SL6122BZ,
SL6122HAB,
SL6122NC

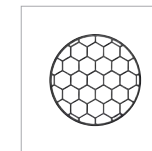

HEX LOUVER (INCLUDED)
SL672

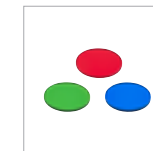

COLORED LENS
SL670BL,
SL670GR,
SL670RD

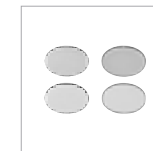

LENS DIFFUSERS
SL6105DF,
SL6105LL,
SL6105SF,
SL6105SB

ORDERING INFORMATION

PRODUCT	RISER HEIGHT	FINISH	LAMP	MOUNTING	LENS
SL622 SIERRA	NR NO RISER	BZ BRONZE	NB NO LAMP	NM NO MOUNT	NL NO LENS
DIRECTIONAL	11 15" RISER (1" DIA.)	HAB HAND-RUBBED	B3 LED LAMP MR16 5W 36°	M1 HEAVY-DUTY STAKE	BL BLUE
SPOT	12 18" RISER (1" DIA.)	ANTIQUE BRASS	90 CRI 2700K	M2 SURFACE	GR GREEN
	13 24" RISER (1" DIA.)	NC NATURAL COPPER	B4 LED LAMP MR16 5W 60°	M4 BUNGEE	RD RED
			90 CRI 2700K	M5 TREE SURFACE	DF DIFFUSER SPREAD LENS
				M6 TREE SCREW-IN	LL LINEAR SPREAD LENS
				M7 GUTTER MOUNT	SF SOLITE SOFT FOCUS LENS
				M10 12" TRIDENT STAKE	SB SANDBLASTED LENS

HEX LOUVER INCLUDED.



Sierra

DIRECTIONAL SPOTLIGHT WITH 50° CUT-OFF SHROUD

DESIGNER: SEAN LAVIN

Sierra directional spotlight features a sleek cylindrical design with a 50° cut-off shroud, delivering precise, glare-reducing illumination. Its adjustable and lockable head rotate up to 234 degrees (+/- 117°) for enhanced aiming. The unit is IP65-rated ensured by fully sealed dome glass and includes a field-replaceable ceramic socket assembly for reliable performance in outdoor environments. Sierra is compatible with various mounting accessories to provide installation flexibility.



BRONZE



HAND-RUBBED ANTIQUE BRASS



NATURAL COPPER

SPECIFICATIONS

DIMENSIONS	
Fixture Height	7.3" / 185 mm
Fixture Width	2.4" / 61 mm
MATERIAL	
Material	Brass or Copper
Finish	Bronze, Hand-Rubbed Antique Brass or Natural Copper
Weight	2.5 lb
SOCKET	
Assembly	Ceramic with spring-reinforced electrical connection
LAMPING	
Lamp Type	MR16 LED (Sold Separately)
Lumens	495, 507
Watts	5W
Voltage	12V
Lead Wire	18 AWG, 36"
Dimming	MLV
CCT	2700K
Color Quality	90 CRI
Color Binning	3 Step
Field Serviceable LED	Yes
Operating Temperature	-30°C min -40°C max
LED Lifetime	36,000 Hours
OPTIONS	
Riser	Standard 1": 15", 18", 24"
Knuckle	Thumb Screw (Included), Countersunk Screw (Included)
Mounting	Heavy-Duty Stake, Deck/Surface Mount, Arbor Bungee Strap, Arbor Tree & Surface Mount, Arbor Tree Mount Screw-In, Arbor Gutter Mount, 12" Trident Stake
Optical Controls	Hex Louver (Included), Colored Lenses: Blue, Green, Red, Optical Lenses: Diffuser Spread, Linear Spread, Solite Soft Focus, Sandblasted
WARRANTY	
Lifetime warranty on manufacturer defects in the construction, but normal warranty applies for bulbs, integrated LEDs and living finishes.	

DIMENSIONS

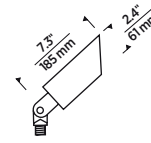

MOUNTING & ACCESSORIES



HEAVY-DUTY STAKE
SL659



DECK/SURFACE MOUNT
SL668HAB,
SL668BZ,
SL668NC



ARBOR BUNGEE STRAP
SL666BZ,
SL666HAB,
SL666NC



ARBOR TREE & SURFACE MOUNT
SL664BZ,
SL664HAB,
SL664NC



ARBOR TREE MOUNT SCREW-IN
SL665BZ,
SL665HAB,
SL665NC



ARBOR GUTTER MOUNT
SL667



12" TRIDENT SPIKE
SL6122BZ,
SL6122HAB,
SL6122NC

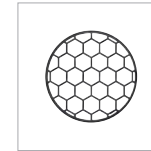

HEX LOUVER (INCLUDED)
SL672

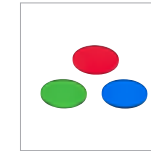

COLORED LENS
SL670BL,
SL670GR,
SL670RD

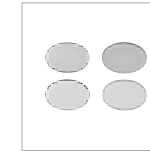

LENS DIFFUSERS
SL6105DF,
SL6105LL,
SL6105SF,
SL6105SB

ORDERING INFORMATION

PRODUCT	RISER HEIGHT	FINISH	LAMP	MOUNTING	LENS
SL623 SIERRA	NR NO RISER	BZ BRONZE	NB NO LAMP	NM NO MOUNT	NL NO LENS
DIRECTIONAL SPOT WITH 50° CUT-OFF SHROUD	11 15" RISER (1" DIA.) 12 18" RISER (1" DIA.) 13 24" RISER (1" DIA.)	HAB HAND-RUBBED ANTIQUE BRASS NC NATURAL COPPER	B3 LED LAMP MR16 5W 36° 90 CRI 2700K B4 LED LAMP MR16 5W 60° 90 CRI 2700K	M1 HEAVY-DUTY STAKE M2 SURFACE M4 BUNGEE M5 TREE SURFACE M6 TREE SCREW-IN M7 GUTTER MOUNT M10 12" TRIDENT STAKE	BL BLUE GR GREEN RD RED DF DIFFUSER SPREAD LENS LL LINEAR SPREAD LENS SF SOLITE SOFT FOCUS LENS SB SANDBLASTED LENS

HEX LOUVER INCLUDED.



Tule

DIRECTIONAL MICRO-SPOTLIGHT

DESIGNER: SEAN LAVIN

Tule is a directional Micro-Spotlight featuring a compact aperture and integrated LED module, paired with a ball swivel for precise and effortless aiming. This micro luminaire is designed to discretely illuminate landscape features and details.



BRONZE



HAND-RUBBED ANTIQUE BRASS



NATURAL COPPER

SPECIFICATIONS

DIMENSIONS

Fixture Height	1.6" / 41 mm
Fixture Width	2" / 51 mm

MATERIAL

Material	Brass or Copper
Finish	Bronze, Hand-Rubbed Antique Brass or Natural Copper
Weight	.5 lb

LAMPING

Lamp Type	Integrated LED
Lumens	236
Watts	3.5W
Voltage	12V
Lead Wire	18 AWG, 36"
Dimming	MLV
CCT	2700K
Color Quality	90 CRI
Color Binning	3 Step
Field Serviceable LED	No
Operating Temperature	-30°C min -40°C max
LED Lifetime	50,000 Hours

OPTIONS

Mounting	Deck/Surface Mount, 5" Stainless Steel Spikes
Optical Controls	Hex Louver (Included)

WARRANTY

Lifetime warranty on manufacturer defects in the construction, but normal warranty applies for bulbs, integrated LEDs and living finishes.

DIMENSIONS

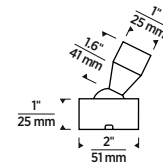

MOUNTING & ACCESSORIES



HEX LOUVER
(INCLUDED)

SL693



DECK/SURFACE
MOUNT

SL668HAB,
SL668BZ,
SL668NC



5" STAINLESS STEEL
SPIKES

SL690

ORDERING INFORMATION

PRODUCT	FINISH	LAMPING	MOUNTING
SL626 TULE MICRO DIRECTIONAL SPOT	BZ BRONZE HAB HAND-RUBBED ANTIQUE BRASS NC NATURAL COPPER	L1 INTEGRATED LED 3.5W 45° 90 CRI 2700K	M2 SURFACE M9 5" STAINLESS STEEL SPIKES

HEX LOUVER INCLUDED.



Tule

MICRO DIRECTIONAL SPOT WITH CUT-OFF SHROUD

DESIGNER: SEAN LAVIN

The Tule Micro Spot with a 50° cut-off shroud combines its small aperture with a precision-engineered shroud to reduce glare. Paired with a ball joint for exact aiming, it delivers focused and refined illumination in a sleek, minimalist design.



BRONZE



HAND-RUBBED ANTIQUE BRASS



NATURAL COPPER

SPECIFICATIONS

DIMENSIONS

Fixture Height	2.5" / 64 mm
Fixture Width	2" / 51 mm

MATERIAL

Material	Brass or Copper
Finish	Bronze, Hand-Rubbed Antique Brass or Natural Copper
Weight	.5 lb

LAMPING

Lamp Type	Integrated LED
Lumens	236
Watts	3.5W
Voltage	12V
Lead Wire	18 AWG, 36"
Dimming	MLV
CCT	2700K
Color Quality	90 CRI
Color Binning	3 Step
Field Serviceable LED	No
Operating Temperature	-30°C min -40°C max
LED Lifetime	50,000 Hours

OPTIONS

Mounting	Deck/Surface Mount, 5" Stainless Steel Spikes
Optical Controls	Hex Louver (Included)

WARRANTY

Lifetime warranty on manufacturer defects in the construction, but normal warranty applies for bulbs, integrated LEDs and living finishes.

DIMENSIONS

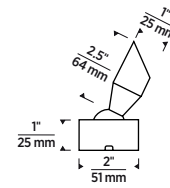

MOUNTING & ACCESSORIES



HEX LOUVER
(INCLUDED)
SL693



DECK/SURFACE
MOUNT
SL668HAB,
SL668BZ,
SL668NC



5" STAINLESS STEEL
SPIKES
SL690

ORDERING INFORMATION

PRODUCT	FINISH	LAMPING	MOUNTING
SL627 TULE MICRO DIRECTIONAL SPOT WITH CUT-OFF SHROUD	BZ BRONZE HAB HAND-RUBBED ANTIQUE BRASS NC NATURAL COPPER	L1 INTEGRATED LED 3.5W 45° 90 CRI 2700K	M2 SURFACE M9 5" STAINLESS STEEL SPIKES

HEX LOUVER INCLUDED.



PATH & AREA LIGHTING



Ascend

DESIGNER: SEAN LAVIN

The Ascend pathway light features a classic tapered shade with a clean, modern design. Its simple, refined form provides effective illumination for outdoor paths and landscapes.



BRONZE WITH
1" RISER



NATURAL COPPER
WITH 1" RISER



HAND-RUBBED
ANTIQUÉ
BRASS WITH 2"
MODERN RISER

SPECIFICATIONS

DIMENSIONS	
Shade Height	3.9" / 99 mm
Shade Diameter	4.7" / 119 mm
Shade & 15" Riser Height	21.7" / 551 mm
15" Riser Height	18" / 457 mm
Shade & 18" Riser Height	24.7" / 627 mm
18" Riser Height	22" / 559 mm
Shade & 24" Riser Height	30.7" / 780 mm
24" Riser Height	28" / 711 mm
MATERIAL	
Material	Brass or Copper
Finish	Bronze, Hand-Rubbed Antique Brass or Natural Copper
Weight	3.6 lbs (with 18" standard riser)
SOCKET	
Assembly	Ceramic with spring-reinforced electrical connection
LAMPING	
Lamp Type	G4 LED (Sold Separately)
Lumens	150, 550
Watts	1.5W, 5W
Voltage	12V
Lead Wire	18 AWG 46" (15" riser), 42" (18" riser), 36" (24" riser)
Dimming	MLV
CCT	2700K
Color Quality	90 CRI
Color Binning	3 Step
Field Serviceable LED	Yes
Operating Temperature	-30°C min -40°C max
LED Lifetime	25,000 Hours
OPTIONS	
Riser	Standard 1": 15", 18", 24"; Modern 2": 15", 18"
Mounting	Heavy-Duty Stake, Deck/Surface Mount
Optical Controls	Cut-Off Reflector
WARRANTY	
Lifetime warranty on manufacturer defects in the construction, but normal warranty applies for bulbs, integrated LEDs and living finishes.	

ORDERING INFORMATION

PRODUCT	RISER HEIGHT	FINISH	LAMP	MOUNTING	REFLECTOR	
SL614 ASCEND	NR	NO RISER	NB	NO LAMP	NF	NO REFLECTOR
	11	15" RISER (1" DIA.)	B1	LED LAMP G4 1.5W 90 CRI 2700K	M1	HEAVY-DUTY STAKE
	12	18" RISER (1" DIA.)	HAB	LED LAMP G4 5W 90 CRI 2700K	M2	SURFACE
	13	24" RISER (1" DIA.)	NC			
	21	15" RISER (1.9" DIA.)				
	22	18" RISER (1.9" DIA.)				

DIMENSIONS

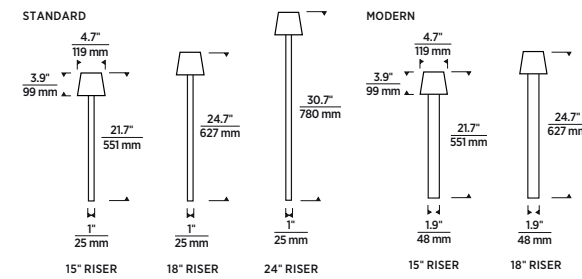

LIGHT DISTRIBUTION

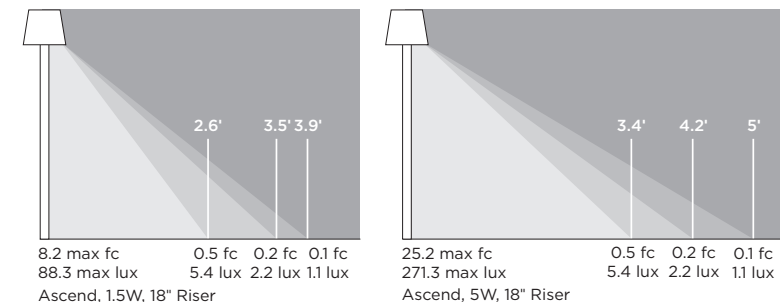

MOUNTING & ACCESSORIES



Balsam

DESIGNER: SEAN LAVIN

The Balsam pathway light features a shade with soft corners that transition seamlessly into straight lines, creating a balanced, refined modern design. Its clean form complements natural landscapes while providing effective illumination for outdoor paths.



BRONZE WITH
1" RISER

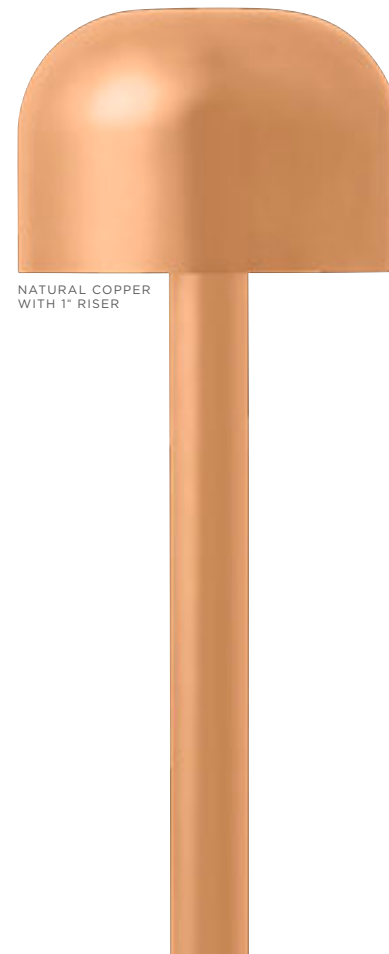

NATURAL COPPER
WITH 1" RISER

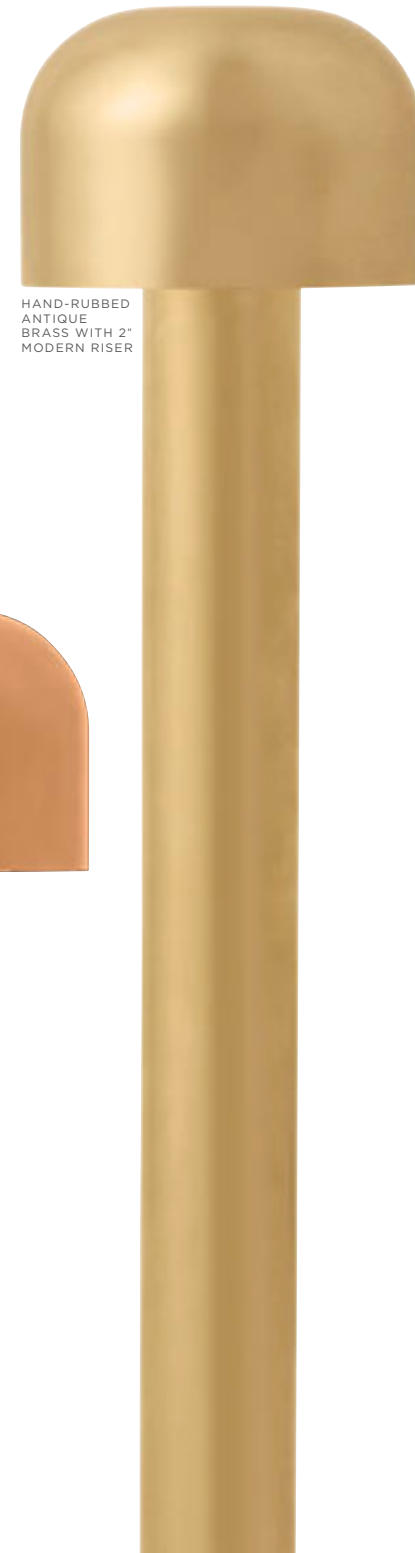

HAND-RUBBED
ANTIQUÉ
BRASS WITH 2"
MODERN RISER

SPECIFICATIONS

DIMENSIONS	
Shade Height	3.3" / 84 mm
Shade Diameter	4.8" / 122 mm
Shade & 15" Riser Height	21.1" / 536 mm
15" Riser Height	18" / 457 mm
Shade & 18" Riser Height	24.1" / 612 mm
18" Riser Height	22" / 559 mm
Shade & 24" Riser Height	30.1" / 765 mm
24" Riser Height	28" / 711 mm
MATERIAL	
Material	Brass or Copper
Finish	Bronze, Hand-Rubbed Antique Brass or Natural Copper
Weight	3.3 lbs (with 18" standard riser)
SOCKET	
Assembly	Ceramic with spring-reinforced electrical connection
LAMPING	
Lamp Type	G4 LED (Sold Separately)
Lumens	150, 550
Watts	1.5W, 5W
Voltage	12V
Lead Wire	18 AWG 46" (15" riser), 42" (18" riser), 36" (24" riser)
Dimming	MLV
CCT	2700K
Color Quality	90 CRI
Color Binning	3 Step
Field Serviceable LED	Yes
Operating Temperature	-30°C min -40°C max
LED Lifetime	25,000 Hours
OPTIONS	
Riser	Standard 1": 15", 18", 24"; Modern 2": 15", 18"
Mounting	Heavy-Duty Stake, Deck/Surface Mount
Optical Controls	Cut-Off Reflector
WARRANTY	
Lifetime warranty on manufacturer defects in the construction, but normal warranty applies for bulbs, integrated LEDs and living finishes.	

DIMENSIONS

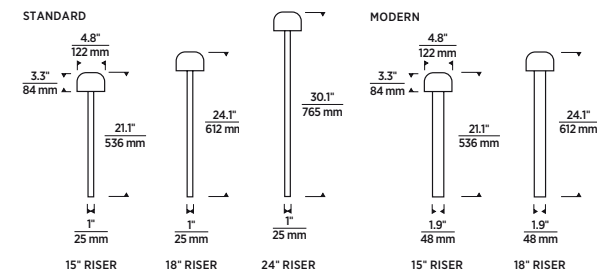

LIGHT DISTRIBUTION

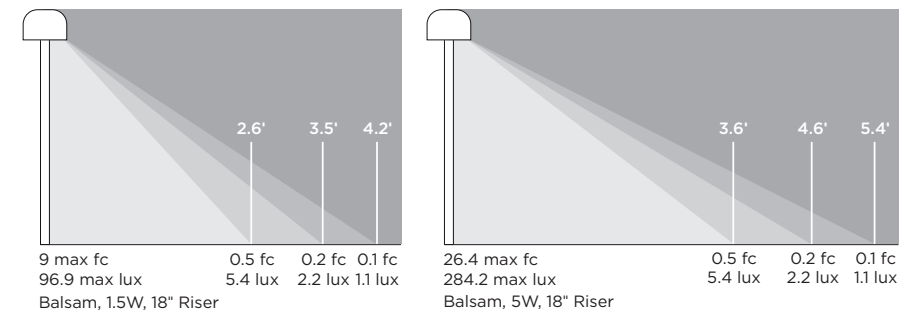

MOUNTING & ACCESSORIES

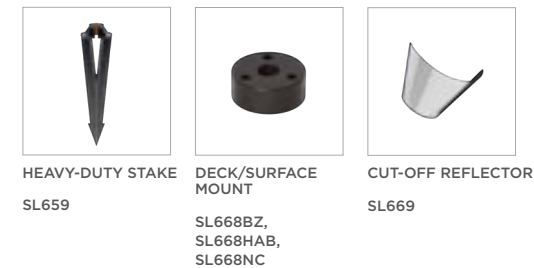

ORDERING INFORMATION

PRODUCT	RISER HEIGHT	FINISH	LAMP	MOUNTING	REFLECTOR	
SL615 BALSAM	NR	NO RISER	NB	NO LAMP	NF	NO REFLECTOR
	11	15" RISER (1" DIA.)	B1	LED LAMP G4 1.5W 90 CRI 2700K	M1	HEAVY-DUTY STAKE
	12	18" RISER (1" DIA.)	HAB	LED LAMP G4 1.5W 90 CRI 2700K	M2	SURFACE
	13	24" RISER (1" DIA.)	NC	LED LAMP G4 5W 90 CRI 2700K		
	21	15" RISER (1.9" DIA.)				A1
	22	18" RISER (1.9" DIA.)				



Peak

DESIGNER: SEAN LAVIN

The Peak pathway light features a classic tapered shade that enhances light distribution. Its lamp-inspired design adds timeless charm while effectively casting illumination across pathways and outdoor spaces.



BRONZE WITH
1" RISER

NATURAL COPPER
WITH 1" RISER

HAND-RUBBED
ANTIQUÉ BRASS
WITH 1" RISER

SPECIFICATIONS

DIMENSIONS	
Shade Height	2.5" / 64 mm
Shade Diameter	5.5" / 140 mm
Shade & 15" Riser Height	21.3" / 541 mm
15" Riser Height	18" / 457 mm
Shade & 18" Riser Height	24.3" / 617 mm
18" Riser Height	22" / 559 mm
Shade & 24" Riser Height	30.3" / 770 mm
24" Riser Height	28" / 711 mm
MATERIAL	
Material	Brass or Copper
Finish	Bronze, Hand-Rubbed Antique Brass or Natural Copper
Weight	3.6 lbs (with 18" standard riser)
SOCKET	
Assembly	Ceramic with spring-reinforced electrical connection
LAMPING	
Lamp Type	G4 LED (Sold Separately)
Lumens	150, 550
Watts	1.5W, 5W
Voltage	12V
Lead Wire	18 AWG 46" (15" riser), 42" (18" riser), 36" (24" riser)
Dimming	MLV
CCT	2700K
Color Quality	90 CRI
Color Binning	3 Step
Field Serviceable LED	Yes
Operating Temperature	-30°C min -40°C max
LED Lifetime	25,000 Hours
OPTIONS	
Riser	Standard 1": 15", 18", 24"
Mounting	Heavy-Duty Stake, Deck/Surface Mount
Optical Controls	Cut-Off Reflector
WARRANTY	
Lifetime warranty on manufacturer defects in the construction, but normal warranty applies for bulbs, integrated LEDs and living finishes.	

DIMENSIONS

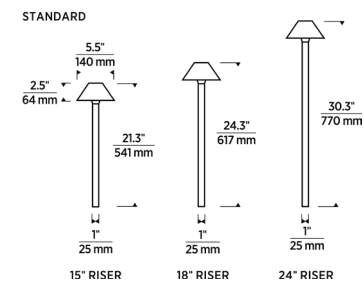

LIGHT DISTRIBUTION

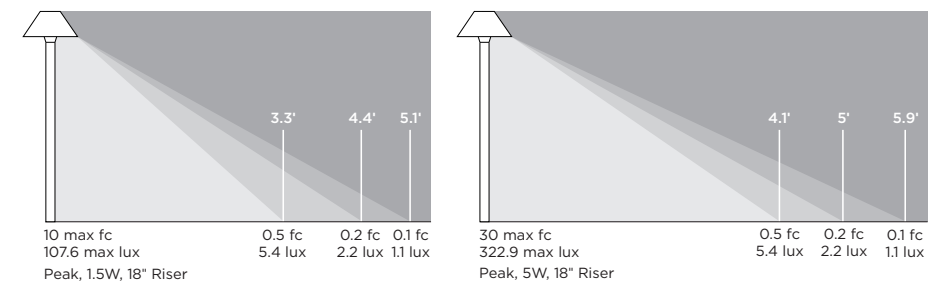

MOUNTING & ACCESSORIES

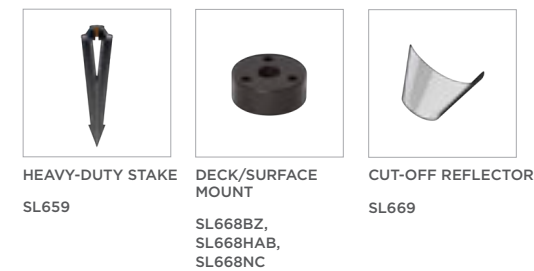

ORDERING INFORMATION

PRODUCT	RISER HEIGHT	FINISH	LAMP	MOUNTING	REFLECTOR
SL611 PEAK	NR NO RISER	BZ BRONZE	NB NO LAMP	NM NO MOUNT	NF NO REFLECTOR
	11 15" RISER (1" DIA.)	HAB HAND-RUBBED ANTIQUE BRASS	B1 LED LAMP G4 1.5W 90 CRI 2700K	M1 HEAVY-DUTY STAKE	A1 CUT-OFF REFLECTOR
	12 18" RISER (1" DIA.)	NC NATURAL COPPER	B2 LED LAMP G4 5W 90 CRI 2700K	M2 SURFACE	
	13 24" RISER (1" DIA.)				



Peak Wide

DESIGNER: SEAN LAVIN

The Peak Wide pathway light features a wide, classic tapered shade designed to maximize light performance. Its larger shade enhances coverage, casting illumination further across walkways and surrounding landscapes.



BRONZE WITH
1" RISER

HAND-RUBBED ANTIQUE
BRASS WITH 1" RISER

NATURAL COPPER
WITH 1" RISER

SPECIFICATIONS

DIMENSIONS	
Shade Height	2.9" / 74 mm
Shade Diameter	8.5" / 216 mm
Shade & 15" Riser Height	21.6" / 549 mm
15" Riser Height	18" / 457 mm
Shade & 18" Riser Height	24.6" / 625 mm
18" Riser Height	22" / 559 mm
Shade & 24" Riser Height	30.6" / 777 mm
24" Riser Height	28" / 711 mm
MATERIAL	
Material	Brass or Copper
Finish	Bronze, Hand-Rubbed Antique Brass or Natural Copper
Weight	3.5 lbs (with 18" standard riser)
SOCKET	
Assembly	Ceramic with spring-reinforced electrical connection
LAMPING	
Lamp Type	G4 LED (Sold Separately)
Lumens	150, 550
Watts	1.5W, 5W
Voltage	12V
Lead Wire	18 AWG 46" (15" riser), 42" (18" riser), 36" (24" riser)
Dimming	MLV
CCT	2700K
Color Quality	90 CRI
Color Binning	3 Step
Field Serviceable LED	Yes
Operating Temperature	-30°C min -40°C max
LED Lifetime	25,000 Hours
OPTIONS	
Riser	Standard 1": 15", 18", 24"
Mounting	Heavy-Duty Stake, Deck/Surface Mount
Optical Controls	Cut-Off Reflector
WARRANTY	
Lifetime warranty on manufacturer defects in the construction, but normal warranty applies for bulbs, integrated LEDs and living finishes.	

DIMENSIONS

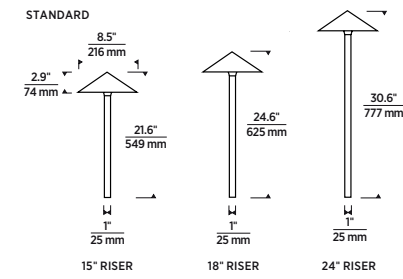

LIGHT DISTRIBUTION

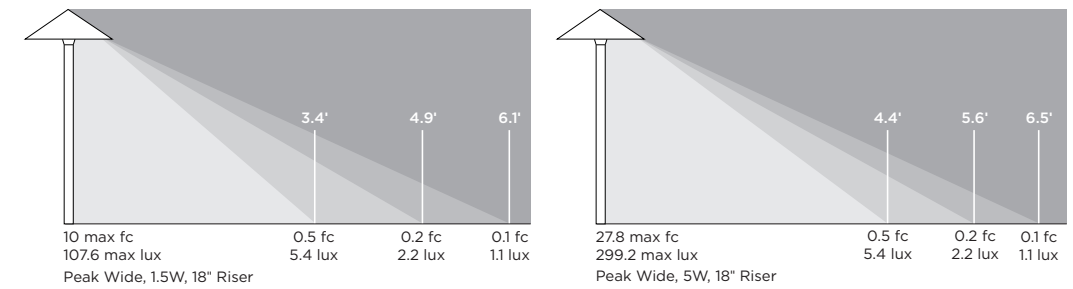

MOUNTING & ACCESSORIES

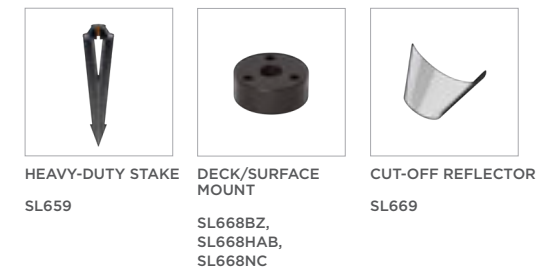

ORDERING INFORMATION

PRODUCT	RISER HEIGHT	FINISH	LAMP	MOUNTING	REFLECTOR	
SL610 PEAK WIDE	NR	NO RISER	NB	NO LAMP	NF	NO REFLECTOR
	11	15" RISER (1" DIA.)	B1	LED LAMP G4 1.5W 90 CRI 2700K	M1	HEAVY-DUTY STAKE
	12	18" RISER (1" DIA.)	HAB	LED LAMP G4 5W 90 CRI 2700K	M2	SURFACE
	13	24" RISER (1" DIA.)	NC			A1



Plateau

DESIGNER: SEAN LAVIN

The Plateau pathway light features a classic soft dome shade with gently rounded sides. Its simple, functional design provides uniform illumination for pathways and gardens, blending seamlessly into the natural landscape.



BRONZE WITH
1" RISER



NATURAL COPPER
WITH 1" RISER



HAND-RUBBED
ANTIQUÉ BRASS
WITH 1" RISER

SPECIFICATIONS

DIMENSIONS	
Shade Height	2.1" / 53 mm
Shade Diameter	5.5" / 140 mm
Shade & 15" Riser Height	21.1" / 536 mm
15" Riser Height	18" / 457 mm
Shade & 18" Riser Height	24.1" / 612 mm
18" Riser Height	22" / 559 mm
Shade & 24" Riser Height	30.1" / 790 mm
24" Riser Height	28" / 711 mm
MATERIAL	
Material	Brass or Copper
Finish	Bronze, Hand-Rubbed Antique Brass or Natural Copper
Weight	2.8 lbs (with 18" standard riser)
SOCKET	
Assembly	Ceramic with spring-reinforced electrical connection
LAMPING	
Lamp Type	G4 LED (Sold Separately)
Lumens	150, 550
Watts	1.5W, 5W
Voltage	12V
Lead Wire	18 AWG 46" (15" riser), 42" (18" riser), 36" (24" riser)
Dimming	MLV
CCT	2700K
Color Quality	90 CRI
Color Binning	3 Step
Field Serviceable LED	Yes
Operating Temperature	-30°C min -40°C max
LED Lifetime	25,000 Hours
OPTIONS	
Riser	Standard 1": 15", 18", 24"
Mounting	Heavy-Duty Stake, Deck/Surface Mount
Optical Controls	Cut-Off Reflector
WARRANTY	
Lifetime warranty on manufacturer defects in the construction, but normal warranty applies for bulbs, integrated LEDs and living finishes.	

DIMENSIONS

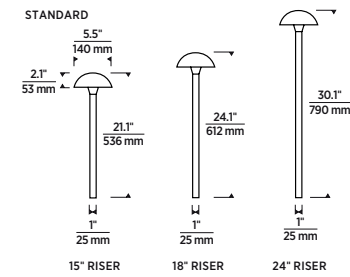

LIGHT DISTRIBUTION

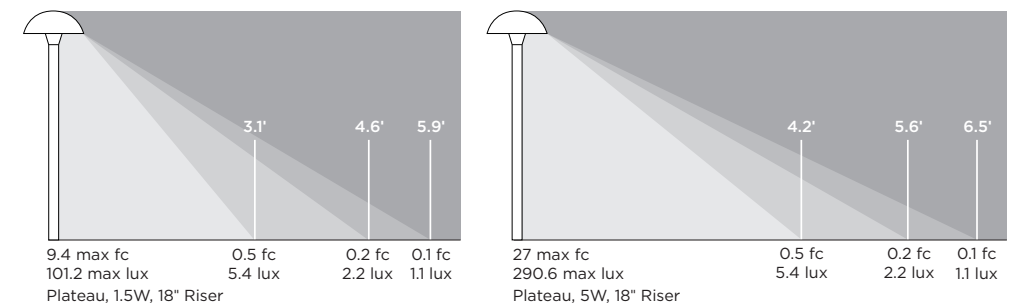

MOUNTING & ACCESSORIES

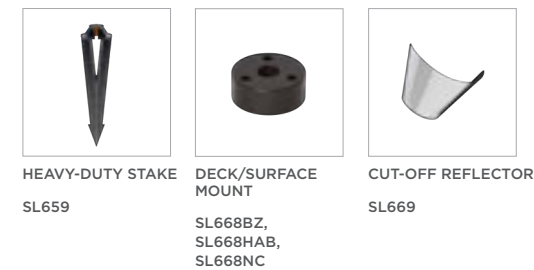

ORDERING INFORMATION

PRODUCT	RISER HEIGHT	FINISH	LAMP	MOUNTING	REFLECTOR
SL613 PLATEAU	NR NO RISER	BZ BRONZE	NB NO LAMP	NM NO MOUNT	NF NO REFLECTOR
	11 15" RISER (1" DIA.)	HAB HAND-RUBBED ANTIQUE BRASS	B1 LED LAMP G4 1.5W 90 CRI 2700K	M1 HEAVY-DUTY STAKE	A1 CUT-OFF REFLECTOR
	12 18" RISER (1" DIA.)	NC NATURAL COPPER	B2 LED LAMP G4 5W 90 CRI 2700K	M2 SURFACE	
	13 24" RISER (1" DIA.)				



Plateau Wide

DESIGNER: SEAN LAVIN

The Plateau Wide pathway light features a classic soft dome shade with gently rounded sides, designed to blend seamlessly into natural landscapes. Its wider shade maximizes light performance, providing increased coverage and uniform illumination for pathways and gardens.



BRONZE WITH
1" RISER

NATURAL COPPER
WITH 1" RISER

HAND-RUBBED
ANTIQUÉ BRASS
WITH 1" RISER

SPECIFICATIONS

DIMENSIONS	
Shade Height	2" / 51 mm
Shade Diameter	7.8" / 198 mm
Shade & 15" Riser Height	20.9" / 531 mm
15" Riser Height	18" / 457 mm
Shade & 18" Riser Height	24.9" / 632 mm
18" Riser Height	22" / 559 mm
Shade & 24" Riser Height	30.9" / 785 mm
24" Riser Height	28" / 711 mm
MATERIAL	
Material	Brass or Copper
Finish	Bronze, Hand-Rubbed Antique Brass or Natural Copper
Weight	3.5 lbs (with 18" standard riser)
SOCKET	
Assembly	Ceramic with spring-reinforced electrical connection
LAMPING	
Lamp Type	G4 LED (Sold Separately)
Lumens	150, 550
Watts	1.5W, 5W
Voltage	12V
Lead Wire	18 AWG 46" (15" riser), 42" (18" riser), 36" (24" riser)
Dimming	MLV
CCT	2700K
Color Quality	90 CRI
Color Binning	3 Step
Field Serviceable LED	Yes
Operating Temperature	-30°C min -40°C max
LED Lifetime	25,000 Hours
OPTIONS	
Riser	Standard 1": 15", 18", 24"
Mounting	Heavy-Duty Stake, Deck/Surface Mount
Optical Controls	Cut-Off Reflector
WARRANTY	
Lifetime warranty on manufacturer defects in the construction, but normal warranty applies for bulbs, integrated LEDs and living finishes.	

DIMENSIONS

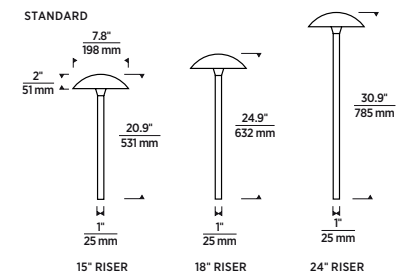

LIGHT DISTRIBUTION

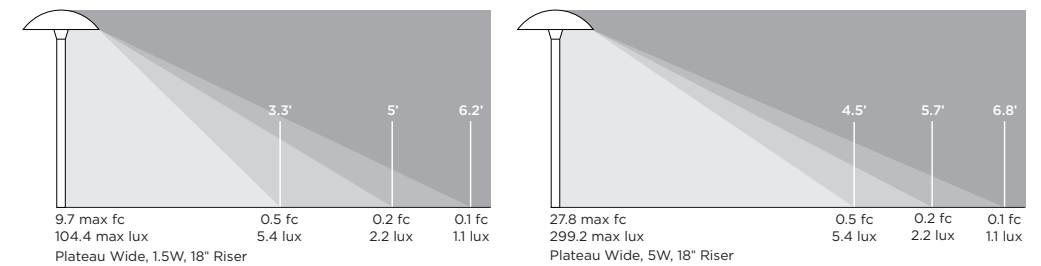

MOUNTING & ACCESSORIES

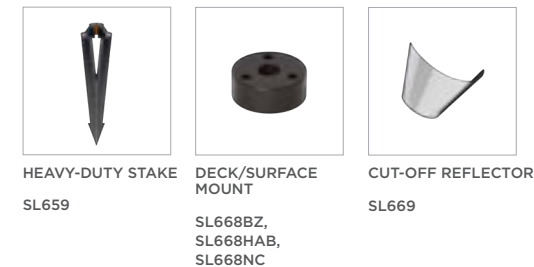

ORDERING INFORMATION

PRODUCT	RISER HEIGHT	FINISH	LAMP	MOUNTING	REFLECTOR
SL612 PLATEAU WIDE	NR NO RISER	BZ BRONZE	NB NO LAMP	NM NO MOUNT	NF NO REFLECTOR
	11 15" RISER (1" DIA.)	HAB HAND-RUBBED ANTIQUE BRASS	B1 LED LAMP G4 1.5W 90 CRI 2700K	M1 HEAVY-DUTY STAKE	A1 CUT-OFF REFLECTOR
	12 18" RISER (1" DIA.)	NC NATURAL COPPER	B2 LED LAMP G4 5W 90 CRI 2700K	M2 SURFACE	



Sentinel Shallow

DESIGNER: SEAN LAVIN

The Sentinel Shallow pathway light features a cylindrical, shallow shade that creates a modern architectural presence. Its low profile shade ensures wider coverage and defined distribution of light.



BRONZE WITH
1" RISER



NATURAL COPPER
WITH 1" RISER



HAND-RUBBED
ANTIQUÉ
BRASS WITH 2"
MODERN RISER

SPECIFICATIONS

DIMENSIONS	
Shade Height	2.2" / 56 mm
Shade Diameter	4.8" / 122 mm
Shade & 15" Riser Height	20.8" / 528 mm
15" Riser Height	18" / 457 mm
Shade & 18" Riser Height	23.8" / 605 mm
18" Riser Height	22" / 559 mm
Shade & 24" Riser Height	29.8" / 757 mm
24" Riser Height	28" / 711 mm
MATERIAL	
Material	Brass or Copper
Finish	Bronze, Hand-Rubbed Antique Brass or Natural Copper
Weight	3.4 lbs (with 18" standard riser)
SOCKET	
Assembly	Ceramic with spring-reinforced electrical connection
LAMPING	
Lamp Type	G4 LED (Sold Separately)
Lumens	150, 550
Watts	1.5W, 5W
Voltage	12V
Lead Wire	18 AWG 46" (15" riser), 42" (18" riser), 36" (24" riser)
Dimming	MLV
CCT	2700K
Color Quality	90 CRI
Color Binning	3 Step
Field Serviceable LED	Yes
Operating Temperature	-30°C min -40°C max
LED Lifetime	25,000 Hours
OPTIONS	
Riser	Standard 1": 15", 18" 24"; Modern 2": 15", 18"
Mounting	Heavy-Duty Stake, Deck/Surface Mount
Optical Controls	Cut-Off Reflector
WARRANTY	
Lifetime warranty on manufacturer defects in the construction, but normal warranty applies for bulbs, integrated LEDs and living finishes.	

DIMENSIONS

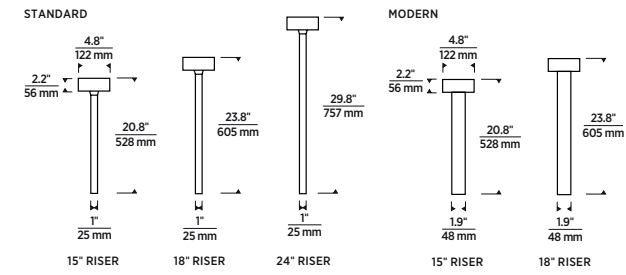

LIGHT DISTRIBUTION

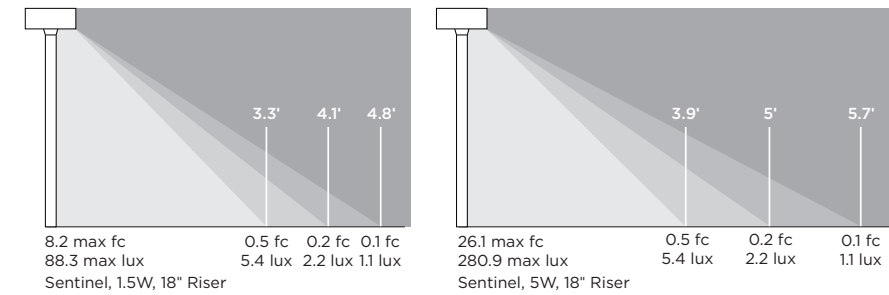

MOUNTING & ACCESSORIES

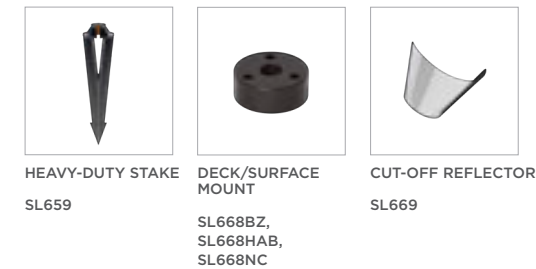

ORDERING INFORMATION

PRODUCT	RISER HEIGHT	FINISH	LAMP	MOUNTING	REFLECTOR
SL617 SENTINEL SHALLOW	NR NO RISER	BZ BRONZE	NB NO LAMP	NM NO MOUNT	NF NO REFLECTOR
	11 15" RISER (1" DIA.)	HAB HAND-RUBBED ANTIQUE BRASS	B1 LED LAMP G4 1.5W 90 CRI 2700K	M1 HEAVY-DUTY STAKE	A1 CUT-OFF REFLECTOR
	12 18" RISER (1" DIA.)				
	13 24" RISER (1" DIA.)	NC NATURAL COPPER	B2 LED LAMP G4 5W 90 CRI 2700K	M2 SURFACE	
	21 15" RISER (1.9" DIA.)				
	22 18" RISER (1.9" DIA.)				



Sentinel Deep

DESIGNER: SEAN LAVIN

The Sentinel Deep Shade pathway light features a straight-sided, deep shade that creates a modern architectural presence. Its taller profile and clean lines provide refined, focused illumination for pathways and outdoor spaces.



BRONZE WITH
1" RISER



NATURAL COPPER
WITH 1" RISER



HAND-RUBBED
ANTIQUÉ
BRASS WITH 2"
MODERN RISER

SPECIFICATIONS

DIMENSIONS	
Shade Height	3.2" / 81 mm
Shade Diameter	4.8" / 122 mm
Shade & 15" Riser Height	21.1" / 536 mm
15" Riser Height	18" / 457 mm
Shade & 18" Riser Height	24.1" / 612 mm
18" Riser Height	22" / 559 mm
Shade & 24" Riser Height	30.1" / 765 mm
24" Riser Height	28" / 711 mm
MATERIAL	
Material	Brass or Copper
Finish	Bronze, Hand-Rubbed Antique Brass or Natural Copper
Weight	3.9 lbs (with 18" standard riser)
SOCKET	
Assembly	Ceramic with spring-reinforced electrical connection
LAMPING	
Lamp Type	G4 LED (Sold Separately)
Lumens	150, 550
Watts	1.5W, 5W
Voltage	12V
Lead Wire	18 AWG 46" (15" riser), 42" (18" riser), 36" (24" riser)
Dimming	MLV
CCT	2700K
Color Quality	90 CRI
Color Binning	3 Step
Field Serviceable LED	Yes
Operating Temperature	-30°C min -40°C max
LED Lifetime	25,000 Hours
OPTIONS	
Riser	Standard 1": 15", 18", 24"; Modern 2": 15", 18"
Mounting	Heavy-Duty Stake, Deck/Surface Mount
Optical Controls	Cut-Off Reflector
WARRANTY	
Lifetime warranty on manufacturer defects in the construction, but normal warranty applies for bulbs, integrated LEDs and living finishes.	

DIMENSIONS

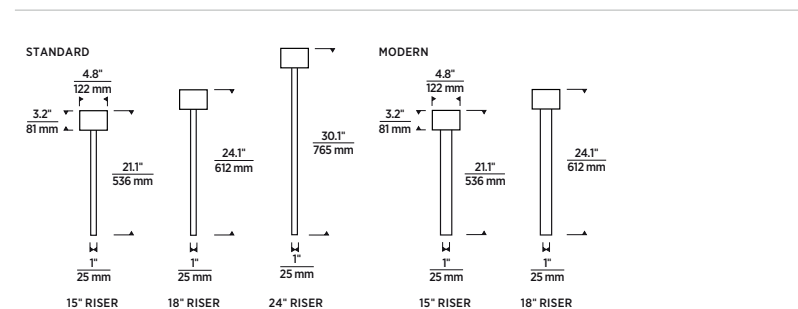

LIGHT DISTRIBUTION

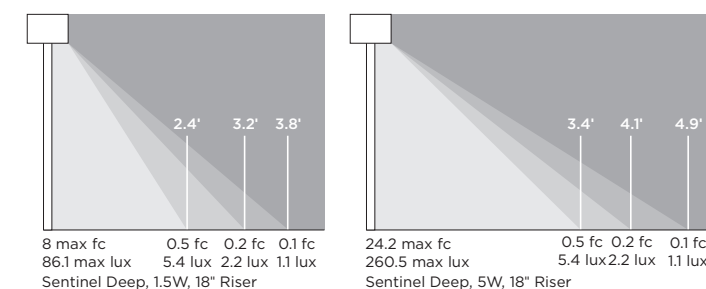

MOUNTING & ACCESSORIES

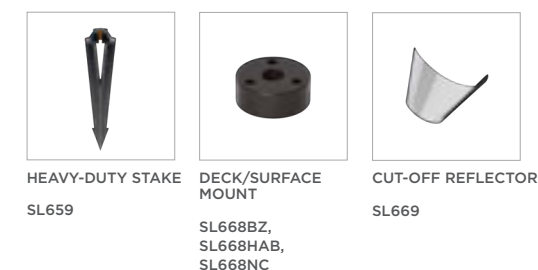

ORDERING INFORMATION

PRODUCT	RISER HEIGHT	FINISH	LAMP	MOUNTING	REFLECTOR
SL616 SENTINEL DEEP	NR	NO RISER	NB	NO MOUNT	NF
	11	15" RISER (1" DIA.)	B1	HEAVY-DUTY STAKE	A1
	12	18" RISER (1" DIA.)	B1	HEAVY-DUTY STAKE	A1
	13	24" RISER (1" DIA.)	B1	HEAVY-DUTY STAKE	A1
	21	15" RISER (1.9" DIA.)	B1	HEAVY-DUTY STAKE	A1
	22	18" RISER (1.9" DIA.)	B2	SURFACE	



Acadia

DESIGNER: SEAN LAVIN

The Acadia pathway light features a modern, minimalist design with a continuous structure and a right-angled form where the light emits. Its integrated LED module light engine coupled with precision optics maximize light performance, providing efficient, forward throw distribution for outdoor spaces.

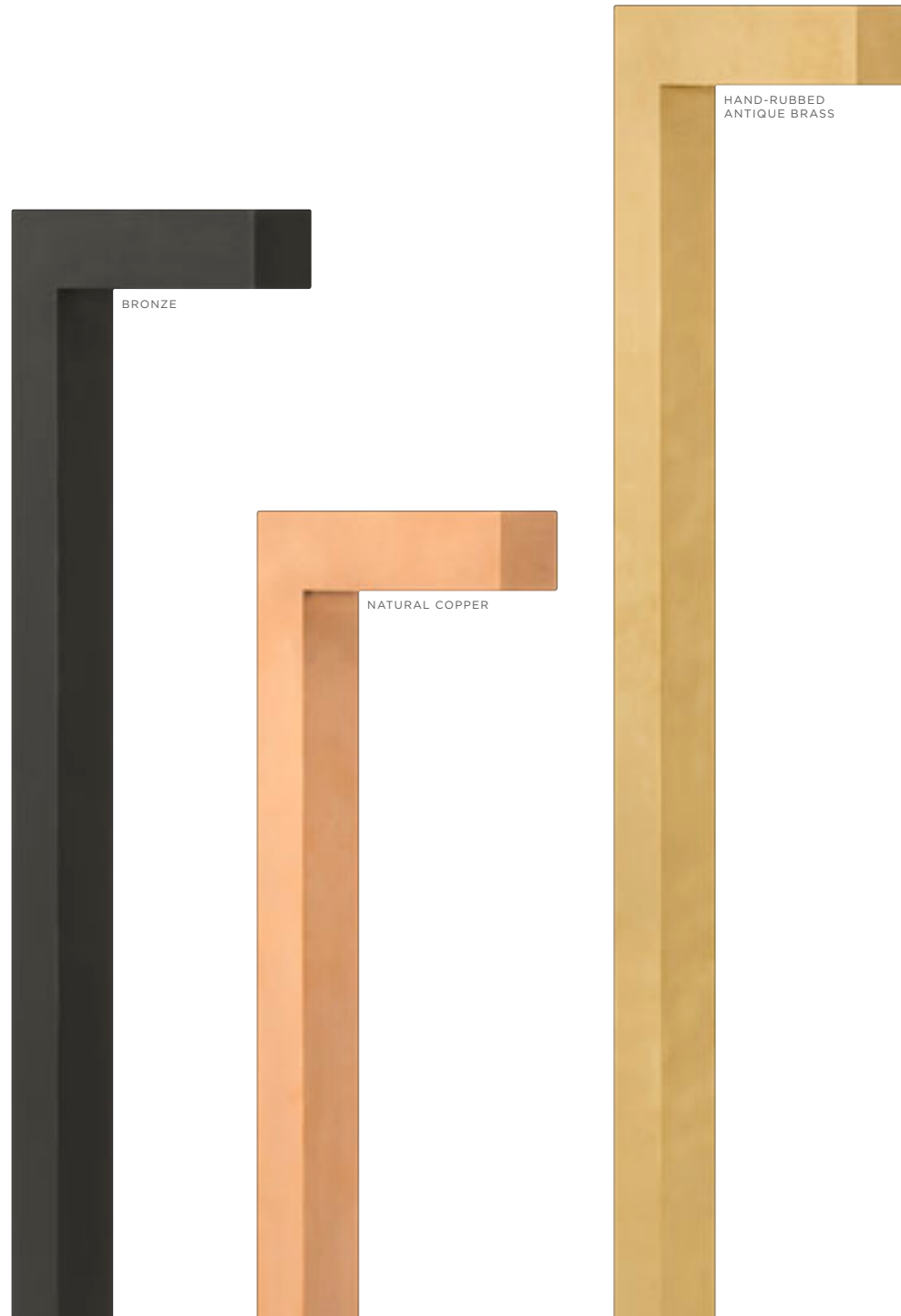

SPECIFICATIONS

DIMENSIONS	
Fixture Height	23" / 584 mm
Fixture Width	1.3" / 33 mm
Fixture Depth	6" / 152 mm
MATERIAL	
Material	Brass or Copper
Finish	Bronze, Hand-Rubbed Antique Brass or Natural Copper
Weight	3.1 lb
LAMPING	
Lamp Type	Integrated LED
Lumens	173
Watts	4.2W
Voltage	12V
Lead Wire	18 AWG, 36"
Dimming	MLV
CCT	2700K
Color Quality	90 CRI
Color Binning	3 Step
Field Serviceable LED	Yes
Operating Temperature	-30°C min -40°C max
LED Lifetime	50,000 Hours
OPTIONS	
Mounting	Heavy-Duty Stake, Deck/Surface Mount
WARRANTY	
Lifetime warranty on manufacturer defects in the construction, but normal warranty applies for bulbs, integrated LEDs and living finishes.	

DIMENSIONS

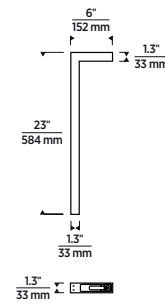

LIGHT DISTRIBUTION

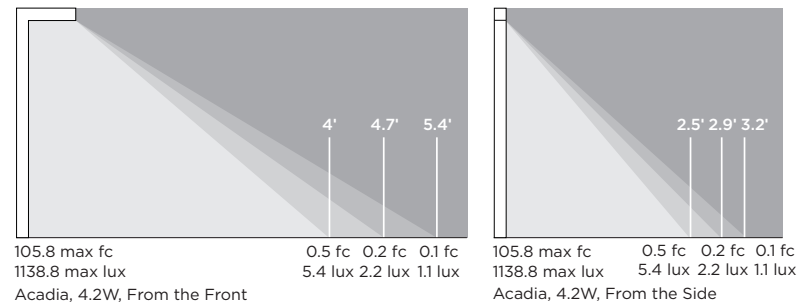

MOUNTING & ACCESSORIES



HEAVY-DUTY STAKE

SL659



DECK/SURFACE MOUNT

SL668BZ,
SL668HAB,
SL668NC

ORDERING INFORMATION

PRODUCT	FINISH	LAMP	MOUNTING
SL620 ACADIA	BZ BRONZE HAB HAND-RUBBED ANTIQUE BRASS NC NATURAL COPPER	L1 INTEGRATED LED 4.2W 90 CRI 2700K	NM NO MOUNT M1 HEAVY-DUTY STAKE M2 SURFACE



Acadia Edge

DESIGNER: SEAN LAVIN

The Acadia Edge pathway light features a modern, minimalist design with a continuous structure and a right-angled form where the light emits. A chamfer feature at the edge softens the look, adding subtle refinement. Its integrated LED module light engine coupled with precision optics maximize light performance, providing efficient, forward throw distribution for outdoor spaces.



BRONZE

NATURAL COPPER

HAND-RUBBED
ANTIQUÉ BRASS

SPECIFICATIONS

DIMENSIONS

Fixture Height	23" / 584 mm
Fixture Width	1.3" / 33 mm
Fixture Depth	6" / 152 mm

MATERIAL

Material	Brass or Copper
Finish	Bronze, Hand-Rubbed Antique Brass or Natural Copper
Weight	3.1 lb

LAMPING

Lamp Type	Integrated LED
Lumens	173
Watts	4.2W
Voltage	12V
Lead Wire	18 AWG, 36"
Dimming	MLV
CCT	2700K
Color Quality	90 CRI
Color Binning	3 Step
Field Serviceable LED	Yes
Operating Temperature	-30°C min -40°C max
LED Lifetime	25,000 Hours

OPTIONS

Mounting	Heavy-Duty Stake, Deck/Surface Mount
----------	--------------------------------------

WARRANTY

Lifetime warranty on manufacturer defects in the construction, but normal warranty applies for bulbs, integrated LEDs and living finishes.

DIMENSIONS

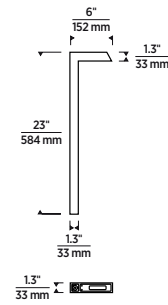

LIGHT DISTRIBUTION

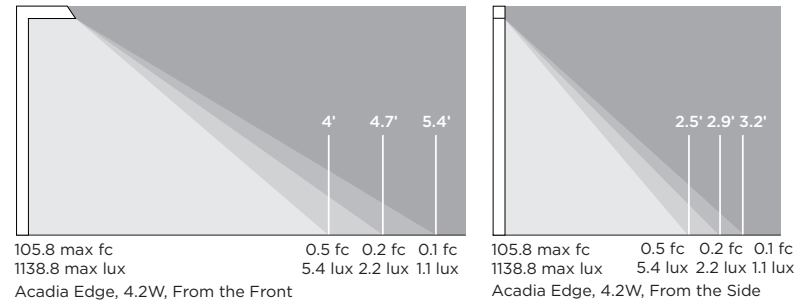

MOUNTING & ACCESSORIES



HEAVY-DUTY STAKE

SL659



DECK/SURFACE MOUNT

SL668BZ,
SL668HAB,
SL668NC

ORDERING INFORMATION

PRODUCT	FINISH	LAMPING	MOUNTING
SL621 ACADIA EDGE	BZ BRONZE HAB HAND RUBBED ANTIQUE BRASS NC NATURAL COPPER	L1 INTEGRATED LED 4.2W 90 CRI 2700K	NM NO MOUNT M1 HEAVY DUTY STAKE M2 SURFACE



Kennett

DESIGNER: SEAN LAVIN

The Kennett pathway light combines the natural elegance of travertine with a sculptural design, available in dark and natural finishes. With its striking form and soft illumination, it functions as both a beautiful outdoor accent and a practical lighting solution.



DARK TRAVERTINE



NATURAL TRAVERTINE

SPECIFICATIONS

DIMENSIONS

Fixture Height	14.5" / 368 mm
Fixture Diameter	9.3" / 236 mm

MATERIAL

Material	Travertine Stone
Finish	Dark Travertine, Natural Travertine
Weight	36.4 lbs

LAMPING

Lamp Type	Integrated LED
Lumens	189
Watts	7W
Voltage	12V
Lead Wire	18 AWG, 36"
Dimming	MLV
CCT	2700K
Color Quality	90 CRI
Color Binning	3 Step
Field Serviceable LED	Yes
Operating Temperature	-30°C min -40°C max
LED Lifetime	50,000 Hours

OPTIONS

Mounting	Concrete Anchors, 12" Stainless Steel Spikes
----------	--

WARRANTY

Lifetime warranty on manufacturer defects in the construction, but normal warranty applies for bulbs, integrated LEDs and living finishes.

DIMENSIONS

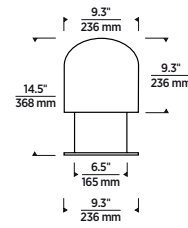

LIGHT DISTRIBUTION

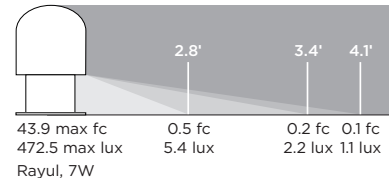

MOUNTING & ACCESSORIES

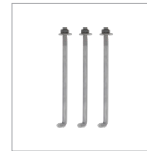

CONCRETE ANCHORS

SL689



12" STAINLESS STEEL SPIKES

SL699

ORDERING INFORMATION

PRODUCT	FINISH	LAMPING	MOUNTING
SL618 KENNETT	DT DARK TRAVERTINE NT NATURAL TRAVERTINE	L1 INTEGRATED LED 7W 90 CRI 2700K	M3 CONCRETE ANCHOR M8 12" STAINLESS STEEL SPIKES



Rayul

DESIGNER: SEAN LAVIN

The Rayul pathway light features a sleek travertine design with a flat top, offering a modern, architectural aesthetic. Its clean lines and refined form evoke the elegance of sculptural furniture, adding sophistication and functionality to outdoor spaces.



DARK TRAVERTINE



NATURAL TRAVERTINE

SPECIFICATIONS

DIMENSIONS

Fixture Height:	12.9" / 328 mm
Fixture Diameter:	9.3" / 236 mm

MATERIAL

Material	Travertine Stone
Finish	Dark Travertine, Natural Travertine
Weight	33.7 lbs

LAMPING

Lamp Type	Integrated LED
Lumens	189
Watts	7W
Voltage	12V
Lead Wire	18 AWG, 36"
Dimming	MLV
CCT	2700K
Color Quality	90 CRI
Color Binning	3 Step
Field Serviceable LED	Yes
Operating Temperature	-30°C min -40°C max
LED Lifetime	50,000 Hours

OPTIONS

Mounting	Concrete Anchors, 12" Stainless Steel Spikes
----------	--

WARRANTY

Lifetime warranty on manufacturer defects in the construction, but normal warranty applies for bulbs, integrated LEDs and living finishes.

DIMENSIONS

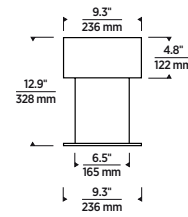

LIGHT DISTRIBUTION

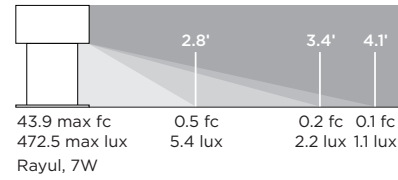

MOUNTING & ACCESSORIES

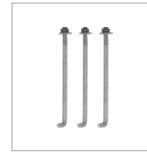

CONCRETE ANCHORS

SL689



12" STAINLESS STEEL SPIKES

SL699

ORDERING INFORMATION

PRODUCT	FINISH	LAMPING	MOUNTING
SL619 RAYUL	DT DARK TRAVERTINE NT NATURAL TRAVERTINE	L1 INTEGRATED LED 7W 90 CRI 2700K	M3 CONCRETE ANCHOR M8 12" STAINLESS STEEL SPIKES



IN-GRADE LIGHTING



Delphini

MICRO FIXED IN-GRADE WITH FLANGE

DESIGNER: SEAN LAVIN

Delphini is a micro fixed in-grade luminaire featuring brass or copper construction and integrated LED module. Design to discretely illuminate paths and highlight architectural details.



BRONZE



HAND-RUBBED ANTIQUE BRASS



NATURAL COPPER

SPECIFICATIONS

DIMENSIONS

Fixture Height	1.3" / 25 mm
Fixture Width	1.5" / 51 mm

MATERIAL

Material	Brass or Copper
Finish	Bronze, Hand-Rubbed Antique Brass or Natural Copper
Weight	.4 lbs

LAMPING

Lamp Type	Integrated LED
Lumens	307
Watts	4.2W
Voltage	12V
Lead Wire	18 AWG, 36"
Dimming	MLV
CCT	2700K
Color Quality	90 CRI
Color Binning	3 Step
Field Serviceable LED	No
Operating Temperature	-30°C min -40°C max
LED Lifetime	50,000 Hours

OPTIONS

Mounting	Deck/Surface Mount, 5" Stainless Steel Spikes
Accessory	Micro Spot Flange

WARRANTY

Lifetime warranty on manufacturer defects in the construction, but normal warranty applies for bulbs, integrated LEDs and living finishes.

DIMENSIONS

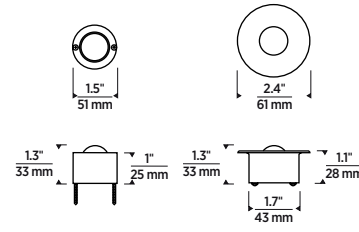

MOUNTING & ACCESSORIES



DECK/SURFACE MOUNT
SL668HAB,
SL668BZ,
SL668NC



5" STAINLESS STEEL SPIKES
SL690



FLANGE
SL692BZ,
SL692HAB,
SL692NC

ORDERING INFORMATION

PRODUCT	FINISH	LAMP	MOUNTING	ACCESSORY
SL629 DELPHINI MICRO FIXED IN-GRADE	BZ BRONZE HAB HAND-RUBBED ANTIQUE BRASS NC NATURAL COPPER	L1 INTEGRATED LED 4.2W 90 CRI 2700K	M2 SURFACE M9 5" STAINLESS STEEL SPIKES	NF NO FLANGE F1 FLANGE*

*FLANGED CANNOT BE INSTALLED AS A SURFACE MOUNT.



Shaver 16 Fixed Open Flat

IN-GRADE

DESIGNER: SEAN LAVIN

The Shaver 16 Fixed Open Flat in-grade light, made from durable brass or copper, offers a sleek, minimalist solution for illuminating pathways and hardscapes. Designed for secure installation with stainless steel spikes, it provides reliable performance and timeless style. As a type of in-grade or well light, it enhances landscapes, pathways, and architectural elements while improving safety and security in outdoor spaces.



BRONZE



HAND-RUBBED ANTIQUE BRASS



NATURAL COPPER

SPECIFICATIONS

DIMENSIONS

Fixture Height with Trim	3.9" / 99 mm
Trim Width	4" / 102 mm
Trim Height	.3" / 7 mm

MATERIAL

Material	Brass or Copper
Finish	Bronze, Hand-Rubbed Antique Brass or Natural Copper
Weight	2.3 lb

SOCKET

Assembly	Ceramic with spring-reinforced electrical connection
----------	--

LAMPING

Lamp Type	MR16 LED (Sold Separately)
Lumens	495
Watts	5W
Voltage	12V
Lead Wire	18 AWG, 36"
Dimming	MLV
CCT	2700K
Color Quality	90 CRI
Color Binning	3 Step
Field Serviceable LED	Yes
Operating Temperature	-30°C min -40°C max
LED Lifetime	36,000 Hours

OPTIONS

Mounting	Concrete Pour, Grass Shield
Optical Controls	Hex Louver (Included); Lenses: Blue, Green, Red; Optical Lenses: Diffuser Spread, Linear Spread, Solite Soft Focus, Sandblasted

WARRANTY

Lifetime warranty on manufacturer defects in the construction, but normal warranty applies for bulbs, integrated LEDs and living finishes.

DIMENSIONS

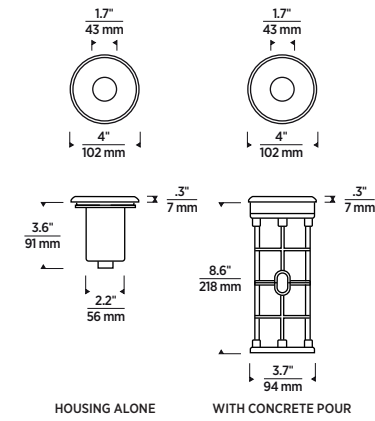

MOUNTING & ACCESSORIES



CONCRETE POUR
SL660

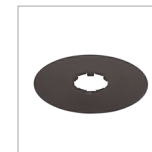

GRASS SHIELD
SL662BZ,
SL662HAB,
SL662NC

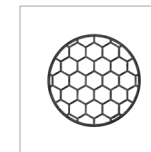

HEX LOUVER
IN-GRADE
(INCLUDED)
SL675

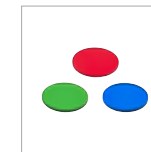

COLORED LENSES
SL670BL,
SL670GR,
SL670RD

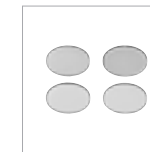

LENS DIFFUSERS
SL6105DF,
SL6105LL,
SL6705SF,
SL6105SB

ORDERING INFORMATION

PRODUCT	FINISH	LAMP	LENS	GRASS SHIELD
SL6120 SHAVER 16 FIXED OPEN FLAT IN-GRADE	BZ BRONZE	NB NO LAMP	NL NO LENS	NG NO GRASS SHIELD
	HAB HAND-RUBBED ANTIQUE BRASS	B3 LED LAMP MR16 5W 36° 90 CRI 2700K	BL BLUE	G1 GRASS SHIELD
	NC NATURAL COPPER		GR GREEN	
			RD RED	
			DF DIFFUSER SPREAD LENS	
			LL LINEAR SPREAD LENS	
			SF SOLITE SOFT FOCUS LENS	
			SB SANDBLASTED LENS	

HEX LOUVER INCLUDED.



Shaver 11 Fixed Open Flat

IN-GRADE

DESIGNER: SEAN LAVIN

The Shaver 11 Fixed Open Flat in-grade light, constructed from brass or copper, provides a durable solution for lighting pathways and hardscapes. It supports secure installation with an optional concrete pour kit and grass shield. A field-replaceable ceramic socket ensures long-term performance, and available optical accessories allow precise beam control. Designed for in-grade applications, it enhances visibility and safety in outdoor environments.



BRONZE



HAND-RUBBED ANTIQUE BRASS



NATURAL COPPER

SPECIFICATIONS

DIMENSIONS

Fixture Height with Trim	3.7" / 94 mm
Trim Width	3.3" / 84 mm
Trim Height	.3" / 7 mm

MATERIAL

Material	Brass or Copper
Finish	Bronze, Hand-Rubbed Antique Brass or Natural Copper
Weight	1.7 lb

SOCKET

Assembly	Ceramic with spring-reinforced electrical connection
----------	--

LAMPING

Lamp Type	MR11 LED (Sold Separately)
Lumens	270
Watts	3W
Voltage	12V
Lead Wire	18 AWG, 36"
Dimming	MLV
CCT	2700K
Color Quality	90 CRI
Color Binning	3 Step
Field Serviceable LED	Yes
Operating Temperature	-30°C min -40°C max
LED Lifetime	25,000 Hours

OPTIONS

Mounting	Concrete Pour, Grass Shield
Optical Controls	Hex Louver (Included); Lenses: Blue, Green, Red; Optical Lenses: Diffuser Spread, Linear Spread, Solite Soft Focus, Sandblasted

WARRANTY

Lifetime warranty on manufacturer defects in the construction, but normal warranty applies for bulbs, integrated LEDs and living finishes.

DIMENSIONS

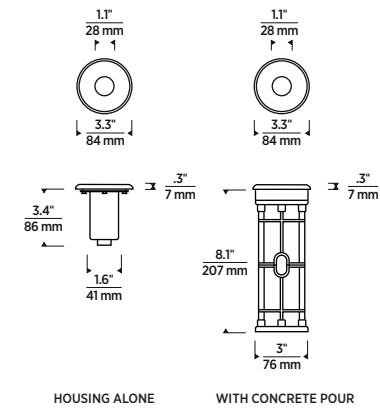

MOUNTING & ACCESSORIES



CONCRETE POUR
SL661



GRASS SHIELD
SL663BZ,
SL663HAB,
SL663NC



HEX LOUVER
IN-GRADE
(INCLUDED)
SL676

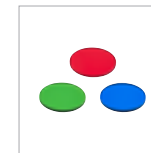

COLORLED LENSES
SL671BL,
SL671GR,
SL671RD



LENS DIFFUSERS
SL6106DF,
SL6106LL,
SL6706SF,
SL6106SB

ORDERING INFORMATION

PRODUCT	FINISH	LAMP	LENS	GRASS SHIELD
SL6121 SHAVER 11 FIXED OPEN FLAT IN-GRADE	BZ BRONZE HAB HAND-RUBBED ANTIQUE BRASS NC NATURAL COPPER	NB NO LAMP B5 LED LAMP MR11 3W 36° 90 CRI 2700K	NL NO LENS BL BLUE GR GREEN RD RED DF DIFFUSER SPREAD LENS LL LINEAR SPREAD LENS SF SOLITE SOFT FOCUS LENS SB SANDBLASTED LENS	NG NO GRASS SHIELD G2 GRASS SHIELD

HEX LOUVER INCLUDED.



Shaver 16 Fixed Open

IN-GRADE

DESIGNER: SEAN LAVIN

The Shaver 16 Fixed Open in-grade light, made from durable brass or copper, offers a sleek, minimalist solution with an open trim to enhance light coverage. Compatible concrete pour kit and grass shield accessory provide reliable and secure installations. The Shaver series features a field-replaceable ceramic socket for long-term performance as well as various optical control accessories to shape the beam of light as intended. As a type of in-grade or well light, it enhances landscapes, pathways, and architectural elements while improving safety and security for outdoor spaces.



BRONZE



HAND-RUBBED ANTIQUE BRASS



NATURAL COPPER

SPECIFICATIONS

DIMENSIONS	
Fixture Height with Trim	4" / 102 mm
Trim Width	4" / 102 mm
Trim Height	.4" / 10 mm
MATERIAL	
Material	Brass or Copper
Finish	Bronze, Hand-Rubbed Antique Brass or Natural Copper
Weight	2.3 lbs
SOCKET	
Assembly	Ceramic with spring-reinforced electrical connection
LAMPING	
Lamp Type	MR16 LED (Sold Separately)
Lumens	495
Watts	5W
Voltage	12V
Lead Wire	18 AWG, 36"
Dimming	MLV
CCT	2700K
Color Quality	90 CRI
Color Binning	3 Step
Field Serviceable LED	Yes
Operating Temperature	-30°C min -40°C max
LED Lifetime	36,000 Hours
OPTIONS	
Mounting	Concrete Pour, Grass Shield
Optical Controls	Hex Louver (Included); Lenses: Blue, Green, Red; Optical Lenses: Diffuser Spread, Linear Spread, Solite Soft Focus, Sandblasted
WARRANTY	
Lifetime warranty on manufacturer defects in the construction, but normal warranty applies for bulbs, integrated LEDs and living finishes.	

DIMENSIONS

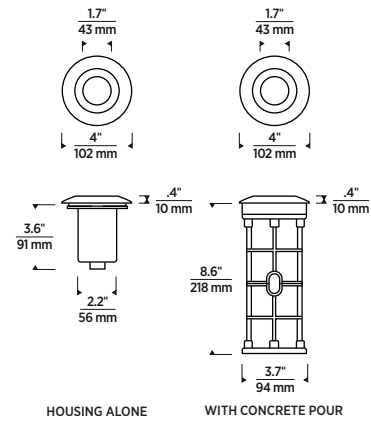

MOUNTING & ACCESSORIES

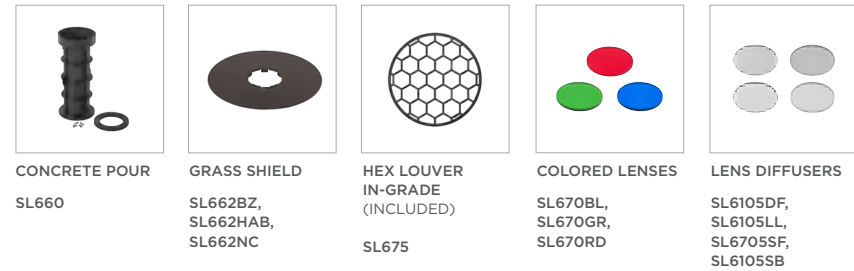

ORDERING INFORMATION

PRODUCT	FINISH	LAMP	LENS	GRASS SHIELD
SL630 SHAVER 16 FIXED OPEN IN-GRADE	BZ BRONZE HAB HAND-RUBBED ANTIQUE BRASS NC NATURAL COPPER	NB NO LAMP B3 LED LAMP MR16 5W 36° 90 CRI 2700K	NL NO LENS BL BLUE GR GREEN RD RED DF DIFFUSER SPREAD LENS LL LINEAR SPREAD LENS SF SOLITE SOFT FOCUS LENS SB SANDBLASTED LENS	NG NO GRASS SHIELD G1 GRASS SHIELD

HEX LOUVER INCLUDED.



Shaver 11 Fixed Open

IN-GRADE

DESIGNER: SEAN LAVIN

The Shaver 11 Fixed Open in-grade light, constructed from brass or copper, provides a durable solution for lighting pathways and hardscapes. The open trim design ensures wider light coverage. It supports secure installation with an optional concrete pour kit and grass shield. A field-replaceable ceramic socket ensures long-term performance, and available optical accessories allow precise beam control. Designed for in-grade applications, it enhances visibility and safety in outdoor environments.



BRONZE



HAND-RUBBED ANTIQUE BRASS



NATURAL COPPER

SPECIFICATIONS

DIMENSIONS

Fixture Height with Trim	3.8" / 97 mm
Trim Width	3.3" / 84 mm
Trim Height	.4" / 10 mm

MATERIAL

Material	Brass or Copper
Finish	Bronze, Hand-Rubbed Antique Brass or Natural Copper
Weight	1.7 lb

SOCKET

Assembly	Ceramic with spring-reinforced electrical connection
----------	--

LAMPING

Lamp Type	MR11 LED (Sold Separately)
Lumens	270
Watts	3W
Voltage	12V
Lead Wire	18 AWG, 36"
Dimming	MLV
CCT	2700K
Color Quality	90 CRI
Color Binning	3 Step
Field Serviceable LED	Yes
Operating Temperature	-30°C min -40°C max
LED Lifetime	25,000 Hours

OPTIONS

Mounting	Concrete Pour, Grass Shield
Optical Controls	Hex Louver (Included); Lenses: Blue, Green, Red; Optical Lenses: Diffuser Spread, Linear Spread, Solite Soft Focus, Sandblasted

WARRANTY

Lifetime warranty on manufacturer defects in the construction, but normal warranty applies for bulbs, integrated LEDs and living finishes.

DIMENSIONS

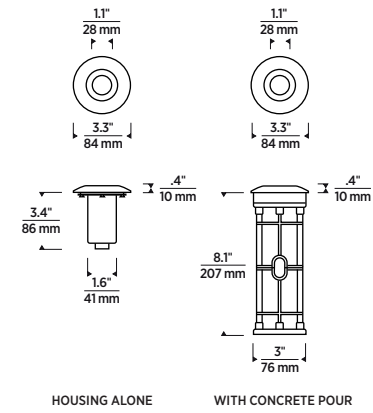

MOUNTING & ACCESSORIES



CONCRETE POUR
SL661

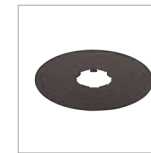

GRASS SHIELD
SL663BZ,
SL663HAB,
SL663NC



HEX LOUVER
IN-GRADE
(INCLUDED)
SL676

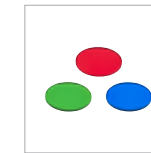

COLORLED LENSES
SL671BL,
SL671GR,
SL671RD

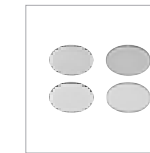

LENS DIFFUSERS
SL6106DF,
SL6106LL,
SL6706SF,
SL6106SB

ORDERING INFORMATION

PRODUCT	FINISH	LAMP	LENS	GRASS SHIELD
SL631 SHAVER 11 FIXED OPEN IN-GRADE	BZ BRONZE	NB NO LAMP	NL NO LENS	NG NO GRASS SHIELD
	HAB HAND-RUBBED ANTIQUE BRASS	B5 LED LAMP MR11 3W 36° 90 CRI 2700K	BL BLUE	G2 GRASS SHIELD
	NC NATURAL COPPER		GR GREEN	
			RD RED	
			DF DIFFUSER SPREAD LENS	
			LL LINEAR SPREAD LENS	
			SF SOLITE SOFT FOCUS LENS	
			SB SANDBLASTED LENS	

HEX LOUVER INCLUDED.



Shaver 16 Fixed

WITH SHROUD

DESIGNER: SEAN LAVIN

The Shaver 16 Fixed with Shroud in-grade light is made from durable brass or copper and securely installed with optional concrete pour kit and grass shield accessories. Its cut-off shroud minimizes unwanted glare while focusing the beam exactly where needed. Additionally, The Shaver series features a field-replaceable ceramic socket for long-term performance as well as various optical control accessories. Shaver enhances landscapes, pathways, and architectural elements with reliable performance and discrete style.



BRONZE



HAND-RUBBED ANTIQUE BRASS



NATURAL COPPER

SPECIFICATIONS

DIMENSIONS	
Fixture Height with Trim	4.8" / 122 mm
Trim Width	4" / 102 mm
Trim Height	1.2" / 30 mm
MATERIAL	
Material	Brass or Copper
Finish	Bronze, Hand-Rubbed Antique Brass or Natural Copper
Weight	2.4 lbs
SOCKET	
Assembly	Ceramic with spring-reinforced electrical connection
LAMPING	
Lamp Type	MR16 LED (Sold Separately)
Lumens	495
Watts	5W
Voltage	12V
Lead Wire	18 AWG, 36"
Dimming	MLV
CCT	2700K
Color Quality	90 CRI
Color Binning	3 Step
Field Serviceable LED	Yes
Operating Temperature	-30°C min -40°C max
LED Lifetime	36,000 Hours
OPTIONS	
Mounting	Concrete Pour, Grass Shield
Optical Controls	Hex Louver (Included); Lenses: Blue, Green, Red, Optical Lenses: Diffuser Spread, Linear Spread, Solite Soft Focus, Sandblasted
WARRANTY	
Lifetime warranty on manufacturer defects in the construction, but normal warranty applies for bulbs, integrated LEDs and living finishes.	

DIMENSIONS

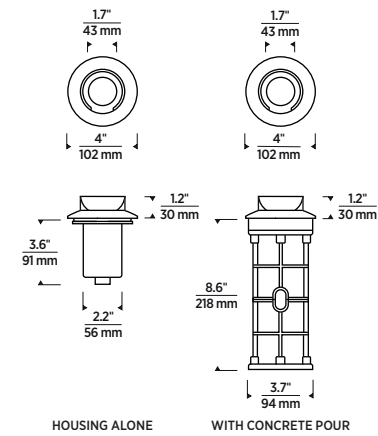

MOUNTING & ACCESSORIES

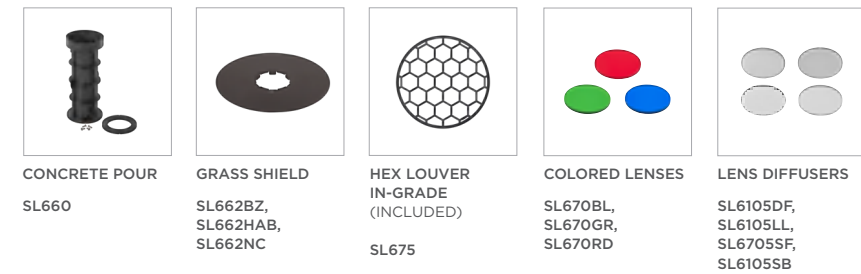

ORDERING INFORMATION

PRODUCT	FINISH	LAMP	LENS	GRASS SHIELD
SL632 SHAVER 16 FIXED WITH CUT-OFF SHROUD	BZ BRONZE	NB NO LAMP	NL NO LENS	NG NO GRASS SHIELD
	HAB HAND-RUBBED ANTIQUE BRASS	B3 LED LAMP MR16 5W 36° 90 CRI 2700K	BL BLUE	G1 GRASS SHIELD
	NC NATURAL COPPER		GR GREEN	
			RD RED	
			DF DIFFUSER SPREAD LENS	
			LL LINEAR SPREAD LENS	
			SF SOLITE SOFT FOCUS LENS	
			SB SANDBLASTED LENS	

HEX LOUVER INCLUDED.



Shaver 11 Fixed

WITH SHROUD

DESIGNER: SEAN LAVIN

The Shaver 11 Fixed with Shroud in-grade light is made from durable brass or copper and securely installed with optional concrete pour kit and grass shield accessories. Its cut-off shroud minimizes unwanted glare while focusing the beam exactly where needed. Additionally, The Shaver series features a field-replaceable ceramic socket for long-term performance as well as various optical control accessories. Shaver enhances landscapes, pathways, and architectural elements with reliable performance and discrete style.



BRONZE



HAND-RUBBED ANTIQUE BRASS



NATURAL COPPER

SPECIFICATIONS

DIMENSIONS

Fixture Height with Trim	4.3" / 109 mm
Trim Width	3.3" / 84 mm
Trim Height	.9" / 23 mm

MATERIAL

Material	Brass or Copper
Finish	Bronze, Hand-Rubbed Antique Brass or Natural Copper
Weight	1.8 lbs

SOCKET

Assembly	Ceramic with spring-reinforced electrical connection
----------	--

LAMPING

Lamp Type	MR11 LED (Sold Separately)
Lumens	270
Watts	3W
Voltage	12V
Lead Wire	18 AWG, 36"
Dimming	MLV
CCT	2700K
Color Quality	90 CRI
Color Binning	3 Step
Field Serviceable LED	Yes
Operating Temperature	-30°C min -40°C max
LED Lifetime	25,000 Hours

OPTIONS

Mounting	Concrete Pour, Grass Shield
Optical Controls	Hex Louver (Included); Lenses: Blue, Green, Red, Optical Lenses: Diffuser Spread, Linear Spread, Solite Soft Focus, Sandblasted

WARRANTY

Lifetime warranty on manufacturer defects in the construction, but normal warranty applies for bulbs, integrated LEDs and living finishes.

DIMENSIONS

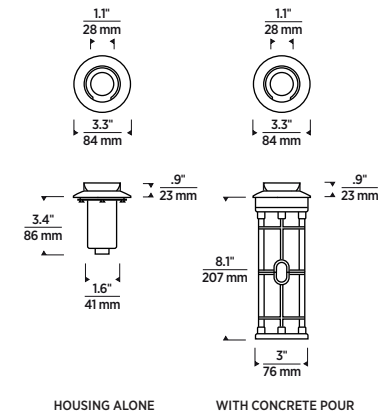

MOUNTING & ACCESSORIES



CONCRETE POUR
SL661



GRASS SHIELD
SL663BZ,
SL663HAB,
SL663NC

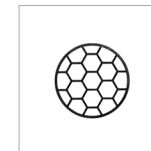

HEX LOUVER
IN-GRADE
(INCLUDED)
SL676

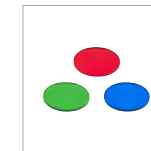

COLORLED LENSES
SL671BL,
SL671GR,
SL671RD

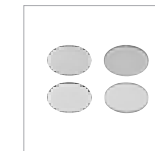

LENS DIFFUSERS
SL6106DF,
SL6106LL,
SL6706SF,
SL6106SB

ORDERING INFORMATION

PRODUCT	FINISH	LAMP	LENS	GRASS SHIELD
SL633 SHAVER 11 FIXED WITH CUT-OFF SHROUD	BZ BRONZE	NB NO LAMP	NL NO LENS	NG NO GRASS SHIELD
	HAB HAND-RUBBED ANTIQUE BRASS	B5 LED LAMP MR11 3W 36° 90 CRI 2700K	BL BLUE	G2 GRASS SHIELD
	NC NATURAL COPPER		GR GREEN	
			RD RED	
			DF DIFFUSER SPREAD LENS	
			LL LINEAR SPREAD LENS	
			SF SOLITE SOFT FOCUS LENS	
			SB SANDBLASTED LENS	

HEX LOUVER INCLUDED.



Shaver 16 Fixed

WITH GRILL GUARD

DESIGNER: SEAN LAVIN

The Shaver 16 Fixed with Grill Guard in-grade light is expertly crafted from durable brass or copper. Its grill guard minimizes glare while directing light upward, creating a defined illumination effect with a decorative pattern. The Shaver series features a field-replaceable ceramic socket for long-term performance as well as various optical control accessories making it ideal choice for discreetly illuminating pathways and hardscapes.



BRONZE



HAND-RUBBED ANTIQUE BRASS



NATURAL COPPER

SPECIFICATIONS

DIMENSIONS	
Fixture Height with Trim	4.2" / 107 mm
Trim Width	4" / 102 mm
Trim Height	.6" / 15 mm
MATERIAL	
Material	Brass or Copper
Finish	Bronze, Hand-Rubbed Antique Brass or Natural Copper
Weight	2.3 lbs
SOCKET	
Assembly	Ceramic with spring-reinforced electrical connection
LAMPING	
Lamp Type	MR16 LED (Sold Separately)
Lumens	495
Watts	5W
Voltage	12V
Lead Wire	18 AWG, 36"
Dimming	MLV
CCT	2700K
Color Quality	90 CRI
Color Binning	3 Step
Field Serviceable LED	Yes
Operating Temperature	-30°C min -40°C max
LED Lifetime	36,000 Hours
OPTIONS	
Mounting	Concrete Pour, Grass Shield
Optical Controls	Hex Louver (Included); Lenses: Blue, Green, Red, Optical Lenses: Diffuser Spread, Linear Spread, Solite Soft Focus, Sandblasted
WARRANTY	
Lifetime warranty on manufacturer defects in the construction, but normal warranty applies for bulbs, integrated LEDs and living finishes.	

DIMENSIONS

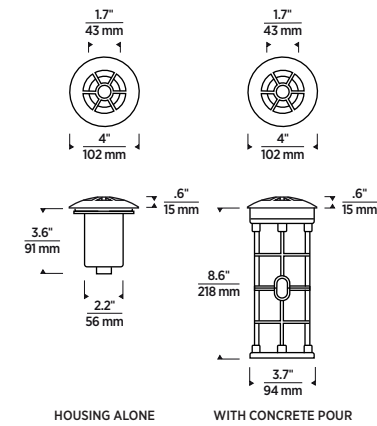

MOUNTING & ACCESSORIES



ORDERING INFORMATION

PRODUCT	FINISH	LAMP	LENS	GRASS SHIELD
SL634 SHAVER 16 FIXED WITH GRILL	BZ BRONZE	NB NO LAMP	NL NO LENS	NG NO GRASS SHIELD
	HAB HAND-RUBBED ANTIQUE BRASS	B3 LED LAMP MR16 5W 36° 90 CRI 2700K	BL BLUE	G1 GRASS SHIELD
	NC NATURAL COPPER		GR GREEN	
			RD RED	
			DF DIFFUSER SPREAD LENS	
			LL LINEAR SPREAD LENS	
			SF SOLITE SOFT FOCUS LENS	
			SB SANDBLASTED LENS	

HEX LOUVER INCLUDED.



Shaver 11 Fixed

WITH GRILL GUARD

DESIGNER: SEAN LAVIN

The Shaver 11 Fixed with Grill Guard in-grade light is expertly crafted from durable brass or copper. Its grill guard minimizes glare while directing light upward, creating a defined illumination effect with a decorative pattern. The Shaver series features a field-replaceable ceramic socket for long-term performance as well as various optical control accessories making it ideal choice for discreetly illuminating pathways and hardscapes.



BRONZE



HAND-RUBBED ANTIQUE BRASS



NATURAL COPPER

SPECIFICATIONS

DIMENSIONS	
Fixture Height with Trim	3.9" / 99 mm
Trim Width	3.3" / 84 mm
Trim Height	.5" / 13 mm
MATERIAL	
Material	Brass or Copper
Finish	Bronze, Hand-Rubbed Antique Brass or Natural Copper
Weight	1.7 lbs
SOCKET	
Assembly	Ceramic with spring-reinforced electrical connection
LAMPING	
Lamp Type	MR11 LED (Sold Separately)
Lumens	270
Watts	3W
Voltage	12V
Lead Wire	18 AWG, 36"
Dimming	MLV
CCT	2700K
Color Quality	90 CRI
Color Binning	3 Step
Field Serviceable LED	Yes
Operating Temperature	-30°C min -40°C max
LED Lifetime	25,000 Hours
OPTIONS	
Mounting	Concrete Pour, Grass Shield
Optical Controls	Hex Louver (Included); Lenses: Blue, Green, Red, Optical Lenses: Diffuser Spread, Linear Spread, Solite Soft Focus, Sandblasted
WARRANTY	
Lifetime warranty on manufacturer defects in the construction, but normal warranty applies for bulbs, integrated LEDs and living finishes.	

DIMENSIONS

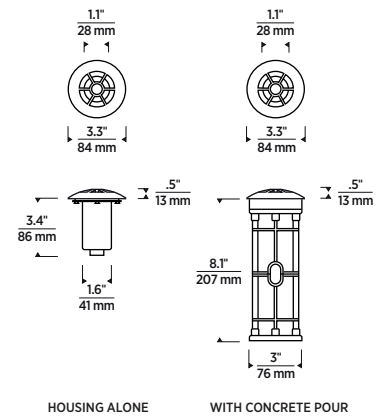

MOUNTING & ACCESSORIES



ORDERING INFORMATION

PRODUCT	FINISH	LAMP	LENS	GRASS SHIELD
SL635 SHAVER 11 FIXED WITH GRILL	BZ BRONZE	NB NO LAMP	NL NO LENS	NG NO GRASS SHIELD
	HAB HAND-RUBBED ANTIQUE BRASS	B5 LED LAMP MR11 3W 36° 90 CRI 2700K	BL BLUE	G2 GRASS SHIELD
	NC NATURAL COPPER		GR GREEN	
			RD RED	
			DF DIFFUSER SPREAD LENS	
			LL LINEAR SPREAD LENS	
			SF SOLITE SOFT FOCUS LENS	
			SB SANDBLASTED LENS	

HEX LOUVER INCLUDED.



Shaver 16 Fixed 90° Aperture

DIRECTIONAL MARKER

DESIGNER: SEAN LAVIN

The Shaver 16 Fixed with 90° Aperture Directional Marker features a low-profile design, expertly crafted from durable brass or copper for secure in-grade installation with optional concrete pour kit and grass shield mounting accessories. Its 90° aperture provides controlled directional illumination, offering a subtle lighting solution for driveways, walkways, and pathways while effectively highlighting hardscape features.



BRONZE



HAND-RUBBED ANTIQUE BRASS



NATURAL COPPER

SPECIFICATIONS

DIMENSIONS

Fixture Height with Trim	4.4" / 112 mm
Trim Width	4" / 102 mm
Trim Height	.8" / 20 mm

MATERIAL

Material	Brass or Copper
Finish	Bronze, Hand-Rubbed Antique Brass or Natural Copper
Weight	2.4 lbs

SOCKET

Assembly	Ceramic with spring-reinforced electrical connection
----------	--

LAMPING

Lamp Type	MR16 LED (Sold Separately)
Lumens	495
Watts	5W
Voltage	12V
Lead Wire	18 AWG, 36"
Dimming	MLV
CCT	2700K
Color Quality	90 CRI
Color Binning	3 Step
Field Serviceable LED	Yes
Operating Temperature	-30°C min -40°C max
LED Lifetime	36,000 Hours

OPTIONS

Mounting	Concrete Pour, Grass Shield
Optical Controls	Lenses: Blue, Green, Red

WARRANTY

Lifetime warranty on manufacturer defects in the construction, but normal warranty applies for bulbs, integrated LEDs and living finishes.

DIMENSIONS

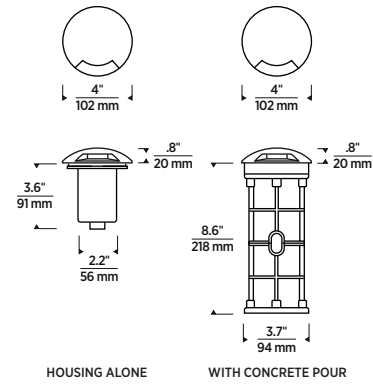

LIGHT DISTRIBUTION

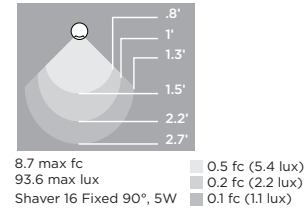

MOUNTING & ACCESSORIES



ORDERING INFORMATION

PRODUCT	FINISH	LAMP	LENS	GRASS SHIELD
SL636 SHAVER 16 FIXED 90° APERTURE	BZ BRONZE HAB HAND-RUBBED ANTIQUE BRASS NC NATURAL COPPER	NB NO LAMP B3 LED LAMP MR16 5W 36° 90 CRI 2700K	NL NO LENS BL BLUE GR GREEN RD RED	NG NO GRASS SHIELD G1 GRASS SHIELD



Shaver 11 Fixed 90° Aperture

DIRECTIONAL MARKER

DESIGNER: SEAN LAVIN

The Shaver 16 Fixed with 90° Aperture Directional Marker features a low-profile design, expertly crafted from durable brass or copper for secure in-grade installation with optional concrete pour kit and grass shield mounting accessories. Its 90° aperture provides controlled directional illumination, offering a subtle lighting solution for driveways, walkways, and pathways while effectively highlighting hardscape features.



BRONZE



HAND-RUBBED ANTIQUE BRASS



NATURAL COPPER

SPECIFICATIONS

DIMENSIONS

Fixture Height with Trim	4.1" / 104 mm
Trim Width	3.3" / 84 mm
Trim Height	.7" / 18 mm

MATERIAL

Material	Brass or Copper
Finish	Bronze, Hand-Rubbed Antique Brass or Natural Copper
Weight	1.8 lbs

SOCKET

Assembly	Ceramic with spring-reinforced electrical connection
----------	--

LAMPING

Lamp Type	MR11 LED (Sold Separately)
Lumens	270
Watts	3W
Voltage	12V
Lead Wire	18 AWG, 36"
Dimming	MLV
CCT	2700K
Color Quality	90 CRI
Color Binning	3 Step
Field Serviceable LED	Yes
Operating Temperature	-30°C min -40°C max
LED Lifetime	25,000 Hours

OPTIONS

Mounting	Concrete Pour, Grass Shield
Optical Controls	Lenses: Blue, Green, Red

WARRANTY

Lifetime warranty on manufacturer defects in the construction, but normal warranty applies for bulbs, integrated LEDs and living finishes.

DIMENSIONS

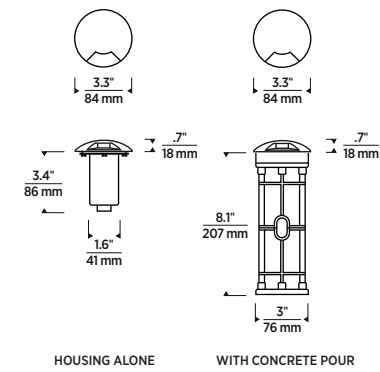

LIGHT DISTRIBUTION

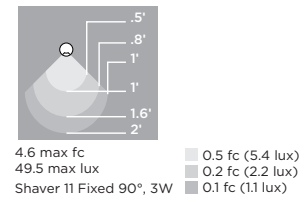

MOUNTING & ACCESSORIES



CONCRETE POUR
SL661



GRASS SHIELD
SL663BZ,
SL663HAB,
SL663NC

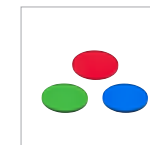

COLORED LENS
SL671BL,
SL671GR,
SL671RD

ORDERING INFORMATION

PRODUCT	FINISH	LAMP	LENS	GRASS SHIELD
SL637 SHAVER 11 FIXED 90° APERTURE	BZ BRONZE HAB HAND-RUBBED ANTIQUE BRASS NC NATURAL COPPER	NB NO LAMP B5 LED LAMP MR11 3W 36° 90 CRI 2700K	NL NO LENS BL BLUE GR GREEN RD RED	NG NO GRASS SHIELD G2 GRASS SHIELD



Shaver 16 Fixed Opposite 90° Aperture

DIRECTIONAL MARKER

DESIGNER: SEAN LAVIN

The Shaver 16 Fixed with Opposite 90° Aperture Directional Marker features a low-profile design, expertly crafted from durable brass or copper for secure in-grade installation with optional concrete pour kit and grass shield mounting accessories. Its opposite 90° aperture provides controlled bi-directional illumination, offering a subtle lighting solution for driveways, walkways, and pathways while effectively highlighting hardscape features.



BRONZE



HAND-RUBBED ANTIQUE BRASS



NATURAL COPPER

SPECIFICATIONS

DIMENSIONS

Fixture Height with Trim	4.4" / 112 mm
Trim Width	4" / 102 mm
Trim Height	.8" / 20 mm

MATERIAL

Material	Brass or Copper
Finish	Bronze, Hand-Rubbed Antique Brass or Natural Copper
Weight	2.4 lbs

SOCKET

Assembly	Ceramic with spring-reinforced electrical connection
----------	--

LAMPING

Lamp Type	MR16 LED (Sold Separately)
Lumens	495
Watts	5W
Voltage	12V
Lead Wire	18 AWG, 36"
Dimming	MLV
CCT	2700K
Color Quality	90 CRI
Color Binning	3 Step
Field Serviceable LED	Yes
Operating Temperature	-30°C min -40°C max
LED Lifetime	36,000 Hours

OPTIONS

Mounting	Concrete Pour, Grass Shield
Optical Controls	Lenses: Blue, Green, Red

WARRANTY

Lifetime warranty on manufacturer defects in the construction, but normal warranty applies for bulbs, integrated LEDs and living finishes.

DIMENSIONS

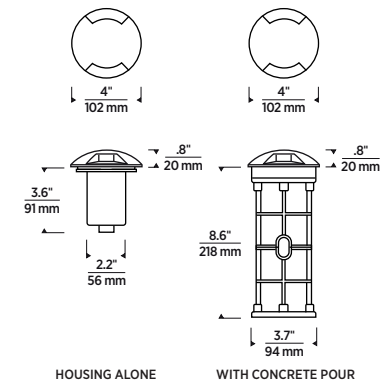

LIGHT DISTRIBUTION

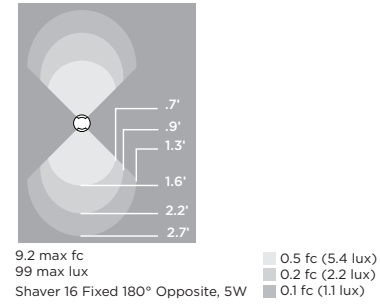

MOUNTING & ACCESSORIES

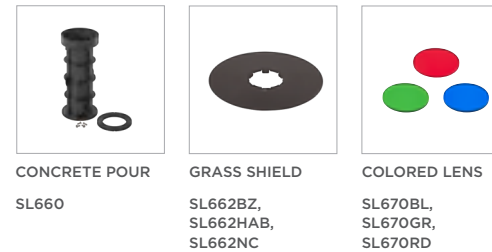

CONCRETE POUR
SL660

GRASS SHIELD
SL662BZ,
SL662HAB,
SL662NC

COLORED LENS
SL670BL,
SL670GR,
SL670RD

ORDERING INFORMATION

PRODUCT	FINISH	LAMP	LENS	GRASS SHIELD
SL638 SHAVER 16 FIXED OPPOSITE 90° APERTURE	BZ BRONZE HAB HAND-RUBBED ANTIQUE BRASS NC NATURAL COPPER	NB NO LAMP B3 LED LAMP MR16 5W 36° 90 CRI 2700K	NL NO LENS BL BLUE GR GREEN RD RED	NG NO GRASS SHIELD G1 GRASS SHIELD



Shaver 11 Fixed Opposite 90° Aperture

DIRECTIONAL MARKER

DESIGNER: SEAN LAVIN

The Shaver 11 Fixed with Opposite 90° Aperture Directional Marker features a low-profile design, expertly crafted from durable brass or copper for secure in-grade installation with optional concrete pour kit and grass shield mounting accessories. Its opposite 90° aperture provides controlled bi-directional illumination, offering a subtle lighting solution for driveways, walkways, and pathways while effectively highlighting hardscape features.



BRONZE



HAND-RUBBED ANTIQUE BRASS



NATURAL COPPER

SPECIFICATIONS

DIMENSIONS

Fixture Height with Trim	4.1" / 104 mm
Trim Width	3.3" / 84 mm
Trim Height	.7" / 18 mm

MATERIAL

Material	Brass or Copper
Finish	Bronze, Hand-Rubbed Antique Brass or Natural Copper
Weight	1.8 lbs

SOCKET

Assembly	Ceramic with spring-reinforced electrical connection
----------	--

LAMPING

Lamp Type	MR11 LED (Sold Separately)
Lumens	270
Watts	3W
Voltage	12V
Lead Wire	18 AWG, 36"
Dimming	MLV
CCT	2700K
Color Quality	90 CRI
Color Binning	3 Step
Field Serviceable LED	Yes
Operating Temperature	-30°C min -40°C max
LED Lifetime	25,000 Hours

OPTIONS

Mounting	Concrete Pour, Grass Shield
Optical Controls	Lenses: Blue, Green, Red

WARRANTY

Lifetime warranty on manufacturer defects in the construction, but normal warranty applies for bulbs, integrated LEDs and living finishes.

DIMENSIONS

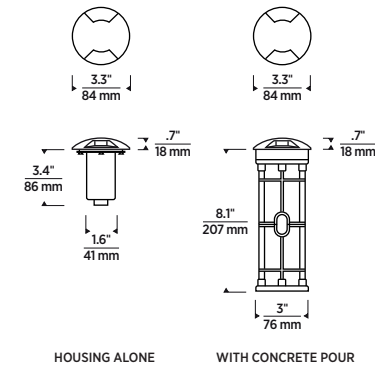

LIGHT DISTRIBUTION

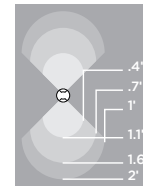

5.7 max fc
61.4 max lux
Shaver 11 Fixed 180° Opposite, 3W

0.5 fc (5.4 lux)
0.2 fc (2.2 lux)
0.1 fc (1.1 lux)

MOUNTING & ACCESSORIES



CONCRETE POUR
SL661

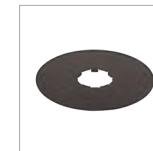

GRASS SHIELD
SL663BZ,
SL663HAB,
SL663NC

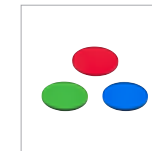

COLORED LENS
SL671BL,
SL671GR,
SL671RD

ORDERING INFORMATION

PRODUCT	FINISH	LAMP	LENS	GRASS SHIELD
SL639 SHAVER 11 FIXED OPPOSITE 90° APERTURE	BZ BRONZE HAB HAND-RUBBED ANTIQUE BRASS NC NATURAL COPPER	NB NO LAMP B5 LED LAMP MR11 3W 36° 90 CRI 2700K	NL NO LENS BL BLUE GR GREEN RD RED	NG NO GRASS SHIELD G2 GRASS SHIELD



Shaver 16 Fixed 180° Aperture

DIRECTIONAL MARKER

DESIGNER: SEAN LAVIN

The Shaver 16 Fixed with 180° Aperture Directional Marker features a low-profile design, expertly crafted from durable brass or copper for secure in-grade installation with optional concrete pour kit and grass shield mounting accessories. Its 180° aperture provides controlled directional illumination, offering a subtle lighting solution for driveways, walkways, and pathways while effectively highlighting hardscape features.



BRONZE



HAND-RUBBED ANTIQUE BRASS



NATURAL COPPER

SPECIFICATIONS

DIMENSIONS

Fixture Height with Trim	4.4" / 112 mm
Trim Width	4" / 102 mm
Trim Height	.8" / 20 mm

MATERIAL

Material	Brass or Copper
Finish	Bronze, Hand-Rubbed Antique Brass or Natural Copper
Weight	2.4 lbs

SOCKET

Assembly	Ceramic with spring-reinforced electrical connection
----------	--

LAMPING

Lamp Type	MR16 LED (Sold Separately)
Lumens	495
Watts	5W
Voltage	12V
Lead Wire	18 AWG, 36"
Dimming	MLV
CCT	2700K
Color Quality	90 CRI
Color Binning	3 Step
Field Serviceable LED	Yes
Operating Temperature	-30°C min -40°C max
LED Lifetime	36,000 Hours

OPTIONS

Mounting	Concrete Pour, Grass Shield
Optical Controls	Lenses: Blue, Green, Red

WARRANTY

Lifetime warranty on manufacturer defects in the construction, but normal warranty applies for bulbs, integrated LEDs and living finishes.

DIMENSIONS

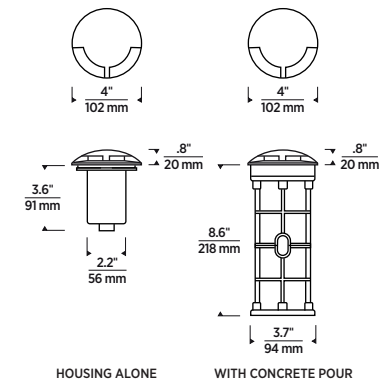

LIGHT DISTRIBUTION

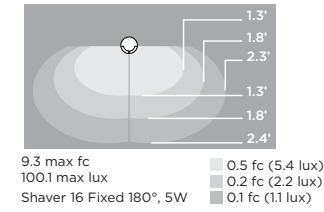

MOUNTING & ACCESSORIES

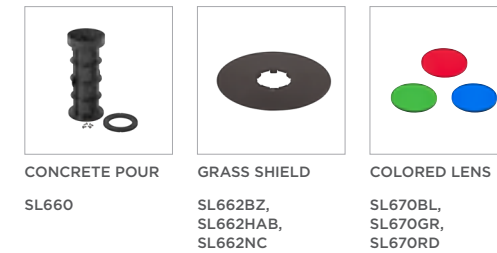

ORDERING INFORMATION

PRODUCT	FINISH	LAMP	LENS	GRASS SHIELD
SL640 SHAVER 16 FIXED 180° APERTURE	BZ BRONZE HAB HAND-RUBBED ANTIQUE BRASS NC NATURAL COPPER	NB NO LAMP B3 LED LAMP MR16 5W 36° 90 CRI 2700K	NL NO LENS BL BLUE GR GREEN RD RED	NG NO GRASS SHIELD G1 GRASS SHIELD



Shaver 11 Fixed 180° Aperture

DIRECTIONAL MARKER

DESIGNER: SEAN LAVIN

The Shaver 11 Fixed with 180° Aperture Directional Marker features a low-profile design, expertly crafted from durable brass or copper for secure in-grade installation with optional concrete pour kit and grass shield mounting accessories. Its 180° aperture provides controlled directional illumination, offering a subtle lighting solution for driveways, walkways, and pathways while effectively highlighting hardscape features.



BRONZE



HAND-RUBBED ANTIQUE BRASS



NATURAL COPPER

SPECIFICATIONS

DIMENSIONS

Fixture Height with Trim	4.1" / 112 mm
Trim Width	3.3" / 84 mm
Trim Height	.7" / 18 mm

MATERIAL

Material	Brass or Copper
Finish	Bronze, Hand-Rubbed Antique Brass or Natural Copper
Weight	1.8 lbs

SOCKET

Assembly	Ceramic with spring-reinforced electrical connection
----------	--

LAMPING

Lamp Type	MR11 LED (Sold Separately)
Lumens	270
Watts	3W
Voltage	12V
Lead Wire	18 AWG, 36"
Dimming	MLV
CCT	2700K
Color Quality	90 CRI
Color Binning	3 Step
Field Serviceable LED	Yes
Operating Temperature	-30°C min -40°C max
LED Lifetime	25,000 Hours

OPTIONS

Mounting	Concrete Pour, Grass Shield
Optical Controls	Lenses: Blue, Green, Red

WARRANTY

Lifetime warranty on manufacturer defects in the construction, but normal warranty applies for bulbs, integrated LEDs and living finishes.

DIMENSIONS

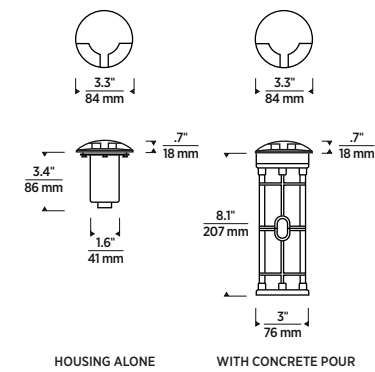

LIGHT DISTRIBUTION

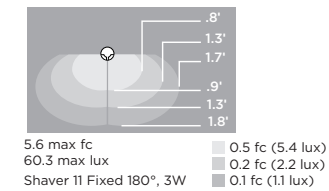

MOUNTING & ACCESSORIES



ORDERING INFORMATION

PRODUCT	FINISH	LAMP	LENS	GRASS SHIELD
SL641 SHAVER 11 FIXED 180° APERTURE	BZ BRONZE HAB HAND-RUBBED ANTIQUE BRASS NC NATURAL COPPER	NB NO LAMP B5 LED LAMP MR11 3W 36° 90 CRI 2700K	NL NO LENS BL BLUE GR GREEN RD RED	NG NO GRASS SHIELD G2 GRASS SHIELD



Shaver 16 Fixed 270° Aperture

DIRECTIONAL MARKER

DESIGNER: SEAN LAVIN

The Shaver 16 Fixed with 270° Aperture Directional Marker features a low-profile design, expertly crafted from durable brass or copper for secure in-grade installation with optional concrete pour kit and grass shield mounting accessories. Its 270° aperture provides controlled multi-directional illumination, offering a subtle lighting solution for driveways, walkways, and pathways while effectively highlighting hardscape features.



BRONZE



HAND-RUBBED ANTIQUE BRASS



NATURAL COPPER

SPECIFICATIONS

DIMENSIONS

Fixture Height with Trim	4.4" / 112 mm
Trim Width	4" / 102 mm
Trim Height	.8" / 20 mm

MATERIAL

Material	Brass or Copper
Finish	Bronze, Hand-Rubbed Antique Brass or Natural Copper
Weight	2.2 lbs

SOCKET

Assembly	Ceramic with spring-reinforced electrical connection
----------	--

LAMPING

Lamp Type	MR16 LED (Sold Separately)
Lumens	495
Watts	5W
Voltage	12V
Lead Wire	18 AWG, 36"
Dimming	MLV
CCT	2700K
Color Quality	90 CRI
Color Binning	3 Step
Field Serviceable LED	Yes
Operating Temperature	-30°C min -40°C max
LED Lifetime	36,000 Hours

OPTIONS

Mounting	Concrete Pour, Grass Shield
Optical Controls	Lenses: Blue, Green, Red

WARRANTY

Lifetime warranty on manufacturer defects in the construction, but normal warranty applies for bulbs, integrated LEDs and living finishes.

DIMENSIONS

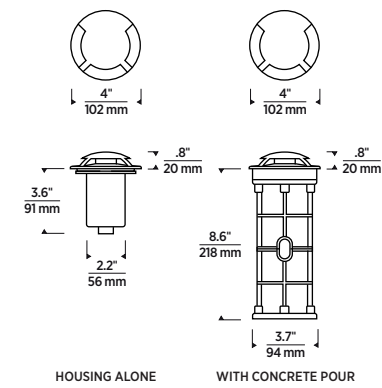

LIGHT DISTRIBUTION

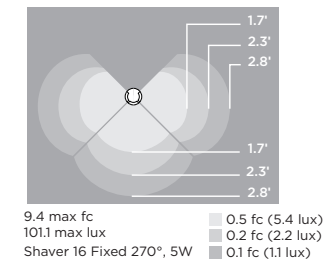

MOUNTING & ACCESSORIES



ORDERING INFORMATION

PRODUCT	FINISH	LAMP	LENS	GRASS SHIELD
SL642 SHAVER 16 FIXED 270° APERTURE	BZ BRONZE HAB HAND-RUBBED ANTIQUE BRASS NC NATURAL COPPER	NB NO LAMP B3 LED LAMP MR16 5W 36° 90 CRI 2700K	NL NO LENS BL BLUE GR GREEN RD RED	NG NO GRASS SHIELD G1 GRASS SHIELD



Shaver 11 Fixed 270° Aperture

DIRECTIONAL MARKER

DESIGNER: SEAN LAVIN

The Shaver 11 Fixed with 270° Aperture Directional Marker features a low-profile design, expertly crafted from durable brass or copper for secure in-grade installation with optional concrete pour kit and grass shield mounting accessories. Its 270° aperture provides controlled multi-directional illumination, offering a subtle lighting solution for driveways, walkways, and pathways while effectively highlighting hardscape features.



BRONZE



HAND-RUBBED ANTIQUE BRASS



NATURAL COPPER

SPECIFICATIONS

DIMENSIONS

Fixture Height with Trim	4.1" / 104 mm
Trim Width	3.3" / 84 mm
Trim Height	.7" / 18 mm

MATERIAL

Material	Brass or Copper
Finish	Bronze, Hand-Rubbed Antique Brass or Natural Copper
Weight	1.6 lbs

SOCKET

Assembly	Ceramic with spring-reinforced electrical connection
----------	--

LAMPING

Lamp Type	MR11 LED (Sold Separately)
Lumens	270
Watts	3W
Voltage	12V
Lead Wire	18 AWG, 36"
Dimming	MLV
CCT	2700K
Color Quality	90 CRI
Color Binning	3 Step
Field Serviceable LED	Yes
Operating Temperature	-30°C min -40°C max
LED Lifetime	25,000 Hours

OPTIONS

Mounting	Concrete Pour, Grass Shield
Optical Controls	Lenses: Blue, Green, Red

WARRANTY

Lifetime warranty on manufacturer defects in the construction, but normal warranty applies for bulbs, integrated LEDs and living finishes.

DIMENSIONS

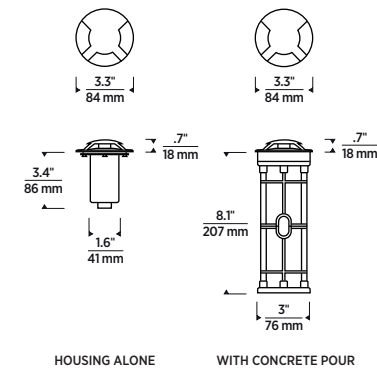

LIGHT DISTRIBUTION

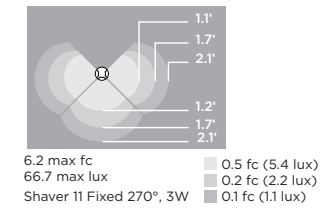

MOUNTING & ACCESSORIES



ORDERING INFORMATION

PRODUCT	FINISH	LAMP	LENS	GRASS SHIELD
SL643 SHAVER 11 FIXED 270° APERTURE	BZ BRONZE HAB HAND-RUBBED ANTIQUE BRASS NC NATURAL COPPER	NB NO LAMP B5 LED LAMP MR11 3W 36° 90 CRI 2700K	NL NO LENS BL BLUE GR GREEN RD RED	NG NO GRASS SHIELD G2 GRASS SHIELD



Shaver 16 Fixed 360° Aperture

DIRECTIONAL MARKER

DESIGNER: SEAN LAVIN

The Shaver 16 Fixed with 360° Aperture Directional Marker features a low-profile design, expertly crafted from durable brass or copper for secure in-grade installation with optional concrete pour kit and grass shield mounting accessories. Its 360° aperture provides controlled multi-directional illumination, offering a subtle lighting solution for driveways, walkways, and pathways while effectively highlighting hardscape features.



BRONZE



HAND-RUBBED ANTIQUE BRASS



NATURAL COPPER

SPECIFICATIONS

DIMENSIONS

Fixture Height with Trim	4.4" / 112 mm
Trim Width	4" / 102 mm
Trim Height	.8" / 20 mm

MATERIAL

Material	Brass or Copper
Finish	Bronze, Hand-Rubbed Antique Brass or Natural Copper
Weight	2.2 lbs

SOCKET

Assembly	Ceramic with spring-reinforced electrical connection
----------	--

LAMPING

Lamp Type	MR16 LED (Sold Separately)
Lumens	495
Watts	5W
Voltage	12V
Lead Wire	18 AWG, 36"
Dimming	MLV
CCT	2700K
Color Quality	90 CRI
Color Binning	3 Step
Field Serviceable LED	Yes
Operating Temperature	-30°C min -40°C max
LED Lifetime	36,000 Hours

OPTIONS

Mounting	Concrete Pour, Grass Shield
Optical Controls	Lenses: Blue, Green, Red

WARRANTY

Lifetime warranty on manufacturer defects in the construction, but normal warranty applies for bulbs, integrated LEDs and living finishes.

DIMENSIONS

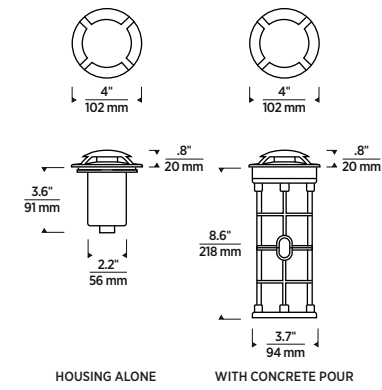

LIGHT DISTRIBUTION

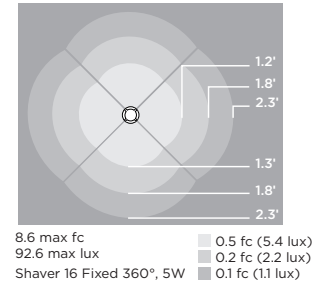

MOUNTING & ACCESSORIES



ORDERING INFORMATION

PRODUCT	FINISH	LAMP	LENS	GRASS SHIELD
SL644 SHAVER 16 FIXED 360° APERTURE	BZ BRONZE	NB NO LAMP	NL NO LENS	NG NO GRASS SHIELD
	HAB HAND-RUBBED ANTIQUE BRASS	B3 LED LAMP MR16 5W 36°	BL BLUE	G1 GRASS SHIELD
	NC NATURAL COPPER	90 CRI 2700K	GR GREEN	
			RD RED	



Shaver 11 Fixed 360° Aperture

DIRECTIONAL MARKER

DESIGNER: SEAN LAVIN

The Shaver 11 Fixed with 360° Aperture Directional Marker features a low-profile design, expertly crafted from durable brass or copper for secure in-grade installation with optional concrete pour kit and grass shield mounting accessories. Its 360° aperture provides controlled multi-directional illumination, offering a subtle lighting solution for driveways, walkways, and pathways while effectively highlighting hardscape features.



BRONZE



HAND-RUBBED ANTIQUE BRASS



NATURAL COPPER

SPECIFICATIONS

DIMENSIONS

Fixture Height with Trim	4.1" / 104 mm
Trim Width	3.3" / 84 mm
Trim Height	.7" / 18 mm

MATERIAL

Material	Brass or Copper
Finish	Bronze, Hand-Rubbed Antique Brass or Natural Copper
Weight	1.6 lbs

SOCKET

Assembly	Ceramic with spring-reinforced electrical connection
----------	--

LAMPING

Lamp Type	MR11 LED (Sold Separately)
Lumens	270
Watts	3W
Voltage	12V
Lead Wire	18 AWG, 36"
Dimming	MLV
CCT	2700K
Color Quality	90 CRI
Color Binning	3 Step
Field Serviceable LED	Yes
Operating Temperature	-30°C min -40°C max
LED Lifetime	25,000 Hours

OPTIONS

Mounting	Concrete Pour, Grass Shield
Optical Controls	Lenses: Blue, Green, Red

WARRANTY

Lifetime warranty on manufacturer defects in the construction, but normal warranty applies for bulbs, integrated LEDs and living finishes.

DIMENSIONS

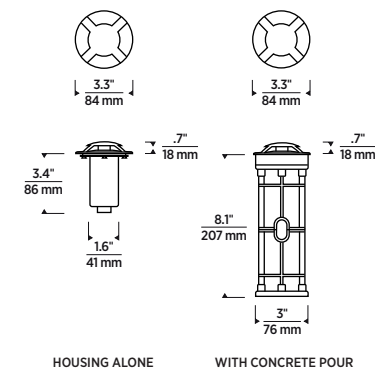

LIGHT DISTRIBUTION

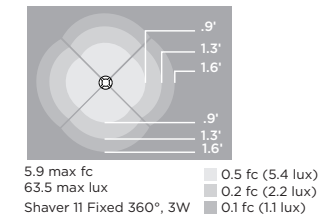

MOUNTING & ACCESSORIES



ORDERING INFORMATION

PRODUCT	FINISH	LAMP	LENS	GRASS SHIELD
SL645 SHAVER 11 FIXED 360° APERTURE	BZ BRONZE	NB NO LAMP	NL NO LENS	NG NO GRASS SHIELD
	HAB HAND-RUBBED ANTIQUE BRASS	B5 LED LAMP MR11 3W 36°	BL BLUE	G2 GRASS SHIELD
	NC NATURAL COPPER	90 CRI 2700K	GR GREEN	
			RD RED	



HARDSCAPE LIGHTING



VISUAL COMFORT & CO.

Brooks 6"

DESIGNER: SEAN LAVIN

The Brooks 6" Hardscape Light is a compact, low-profile fixture designed for seamless integration beneath capstones, stair treads, or wall ledges. It mounts securely using a stainless-steel bracket prior to final hardscape placement. Expertly constructed from solid brass or copper, Brooks features an integrated LED module light engine to deliver consistent linear illumination. Engineered for durability and visual comfort, Brooks enhances safety while accentuating architectural features of outdoor spaces.



BRONZE



HAND-RUBBED ANTIQUE BRASS



NATURAL COPPER

SPECIFICATIONS

DIMENSIONS

Fixture Height	.9" / 23 mm
Fixture Width	6" / 152 mm
Fixture Depth	3.2" / 81 mm

MATERIAL

Material	Brass or Copper
Finish	Bronze, Hand-Rubbed Antique Brass or Natural Copper
Weight	1 lb

LAMPING

Lamp Type	Integrated LED
Lumens	148
Watts	3.1W
Voltage	12V
Lead Wire	18 AWG, 36"
Dimming	MLV
CCT	2700K
Color Quality	90 CRI
Color Binning	3 Step
Field Serviceable LED	No
Operating Temperature	-30°C min -40°C max
LED Lifetime	50,000 Hours

WARRANTY

Lifetime warranty on manufacturer defects in the construction, but normal warranty applies for bulbs, integrated LEDs and living finishes.

DIMENSIONS

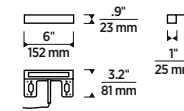

ORDERING INFORMATION

PRODUCT	FINISH	LAMPING
SL646 BROOKS 6" HARDSCAPE	BZ BRONZE HAB HAND-RUBBED ANTIQUE BRASS NC NATURAL COPPER	L1 INTEGRATED LED 3.1W 90 CRI 2700K



Brooks 12"

DESIGNER: SEAN LAVIN

The Brooks 12" Hardscape Light offers the same refined integration as the 6" model, in a longer form factor ideal for broader applications such as extended wall runs, seat walls, or wide stair treads. It mounts using a stainless-steel bracket for secure installation prior to capstone placement. Made from solid brass or copper, Brooks features an integrated LED module light engine to deliver consistent linear illumination. Engineered for durability and visual comfort, Brooks enhances safety while accentuating architectural features of outdoor spaces.



BRONZE



HAND-RUBBED ANTIQUE BRASS



NATURAL COPPER

SPECIFICATIONS

DIMENSIONS

Fixture Height	.9" / 23 mm
Fixture Width	12" / 305 mm
Fixture Depth	3.2" / 81 mm

MATERIAL

Material	Brass or Copper
Finish	Bronze, Hand-Rubbed Antique Brass or Natural Copper
Weight	1.5 lbs

LAMPING

Lamp Type	Integrated LED
Lumens	227
Watts	5.2W
Voltage	12V
Lead Wire	18 AWG, 36"
Dimming	MLV
CCT	2700K
Color Quality	90 CRI
Color Binning	3 Step
Field Serviceable LED	No
Operating Temperature	-30°C min -40°C max
LED Lifetime	50,000 Hours

WARRANTY

Lifetime warranty on manufacturer defects in the construction, but normal warranty applies for bulbs, integrated LEDs and living finishes.

DIMENSIONS

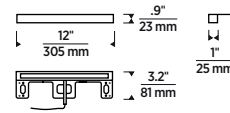

ORDERING INFORMATION

PRODUCT	FINISH	LAMPING
SL647 BROOKS 12" HARDSCAPE	BZ BRONZE HAB HAND-RUBBED ANTIQUE BRASS NC NATURAL COPPER	L1 INTEGRATED LED 5.2W 90 CRI 2700K



Brooks 18"

DESIGNER: SEAN LAVIN

The Brooks 18" Hardscape Light is the longest of the series, designed to deliver broad, even illumination across long runs of seat walls, retaining walls, or wide steps. It installs with the same stainless steel mounting bracket system, ensuring secure placement beneath capstones or ledges. Made from solid brass or copper, Brooks features an integrated LED module light engine to deliver consistent linear illumination. Its extended length minimizes fixture count while providing uniform, low-glare lighting that enhances safety and architectural features across expansive surfaces.



BRONZE



HAND-RUBBED ANTIQUE BRASS



NATURAL COPPER

SPECIFICATIONS

DIMENSIONS

Fixture Height	.9" / 23 mm
Fixture Width	18" / 457 mm
Fixture Depth	3.2" / 81 mm

MATERIAL

Material	Brass or Copper
Finish	Bronze, Hand-Rubbed Antique Brass or Natural Copper
Weight	2 lbs

LAMPING

Lamp Type	Integrated LED
Lumens	297
Watts	7.2W
Voltage	12V
Lead Wire	18 AWG, 36"
Dimming	MLV
CCT	2700K
Color Quality	90 CRI
Color Binning	3 Step
Field Serviceable LED	No
Operating Temperature	-30°C min -40°C max
LED Lifetime	50,000 Hours

WARRANTY

Lifetime warranty on manufacturer defects in the construction, but normal warranty applies for bulbs, integrated LEDs and living finishes.

DIMENSIONS

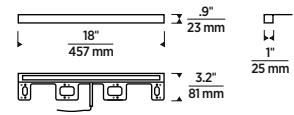

ORDERING INFORMATION

PRODUCT	FINISH	LAMPING
SL648 BROOKS 18" HARDSCAPE	BZ BRONZE HAB HAND-RUBBED ANTIQUE BRASS NC NATURAL COPPER	L1 INTEGRATED LED 7.2W 90 CRI 2700K



STEP LIGHTING



Kaidan Square Aperture

12V STEP LIGHT

DESIGNER: SEAN LAVIN

The Kaidan Square Aperture 12V Step Light features a concealed light source that provides gentle, downward illumination to enhance safety and ambiance in outdoor environments. Amber integrated LED module light engine is ideal for coastal and spectrum-sensitive applications. Expertly crafted from durable brass, copper, or aluminum, Kaidan is designed for seamless integration into steps and walls and fits into any standard single-gang junction box. Available in five finishes, it offers a sleek and versatile lighting solution for both residential and commercial settings.



BRONZE



HAND-RUBBED ANTIQUE BRASS



NATURAL COPPER



MATTE WHITE

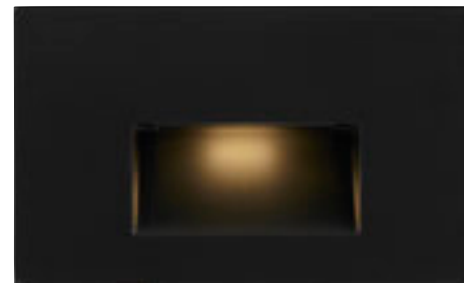

NIGHTSHADE BLACK

SPECIFICATIONS

DIMENSIONS

Fixture Height	3" / 76 mm
Fixture Width	5" / 127 mm

MATERIAL

Material	Brass, Copper, or Aluminum**
Finish	Bronze, Hand-Rubbed Antique Brass, Matte White, Natural Copper, or Nightshade Black
Weight	1 lb

LAMPING

Lamp Type	Integrated LED
Lumens	42
Watts	3.3W
Voltage	12V
Lead Wire	18 AWG, 36"
Dimming	MLV
CCT	Turtle (Amber 585-600nm)
Field Serviceable LED	No
Operating Temperature	-30°C min -40°C max
LED Lifetime	50,000 Hours

WARRANTY

Lifetime warranty on manufacturer defects in the construction, but normal warranty applies for bulbs, integrated LEDs and living finishes.

**Aluminum construction is used for Matte White and Nightshade Black Fixtures.

DIMENSIONS

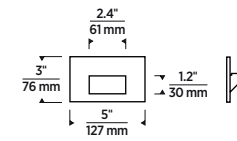

ORDERING INFORMATION

PRODUCT	FINISH	LAMP
SL6101 KAIDAN SQUARE APERTURE 12V STEP LIGHT	BZ BRONZE HAB HAND-RUBBED ANTIQUE BRASS MW MATTE WHITE* NC NATURAL COPPER B NIGHTSHADE BLACK*	T1 INTEGRATED LED 3.3W TURTLE (AMBER 585-600NM)

*Nightshade Black and Matte White damp rated for indoor use.



Kaidan Square Aperture

120V STEP LIGHT

DESIGNER: SEAN LAVIN

The Kaidan Square Aperture 120V Step Light features a concealed light source that delivers a uniform, downward illumination—enhancing safety along stairways, pathways, and wall perimeters. Designed to fit into any standard single-gang junction box, it is installed cleanly into masonry or architectural wall surfaces. Constructed from durable brass, copper, or aluminum, Kaidan is available in five finish options. The integrated 2700K LED module light engine provides a low-glare solution for residential and commercial step lighting applications.



BRONZE



HAND-RUBBED ANTIQUE BRASS



NATURAL COPPER

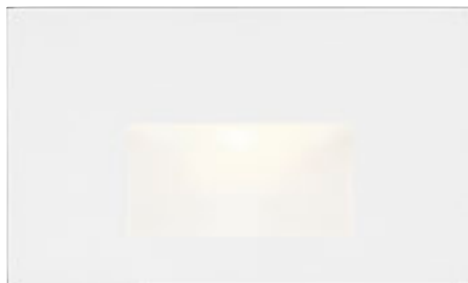

MATTE WHITE

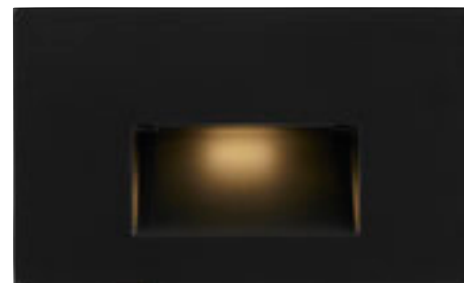

NIGHTSHADE BLACK

SPECIFICATIONS

DIMENSIONS

Fixture Height	3" / 76 mm
Fixture Width	5" / 127 mm

MATERIAL

Material	Brass, Copper, or Aluminum**
Finish	Bronze, Hand-Rubbed Antique Brass, Matte White, Natural Copper, or Nightshade Black
Weight	1 lb

LAMPING

Lamp Type	Integrated LED
Lumens	114
Watts	3.7W
Voltage	120V
Lead Wire	18 AWG, 36"
Dimming	ELV, TRIAC
CCT	2700K
Color Quality	90 CRI
Color Binning	3 Step
Field Serviceable LED	No
Operating Temperature	-30°C min -40°C max
LED Lifetime	50,000 Hours

WARRANTY

Lifetime warranty on manufacturer defects in the construction, but normal warranty applies for bulbs, integrated LEDs and living finishes.

**Aluminum construction is used for Matte White and Nightshade Black Fixtures.

DIMENSIONS

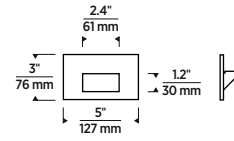

ORDERING INFORMATION

PRODUCT	FINISH	LAMP
SL655 K Aidan Square Aperture 120V Step Light	BZ BRONZE HAB HAND-RUBBED ANTIQUE BRASS MW MATTE WHITE* NC NATURAL COPPER B NIGHTSHADE BLACK*	L1 INTEGRATED LED 3.7W 90 CRI 2700K

*Nightshade Black and Matte White damp rated for indoor use.



Kaidan Hex Aperture

12V STEP LIGHT

DESIGNER: SEAN LAVIN

The Kaidan Hex Aperture 12V Step Light features a concealed light source that provides gentle, downward illumination to enhance safety and ambiance in outdoor environments. The hexagonal faceplate maintains low-glare performance while the integrated amber LED module light engine provides an ideal solution for coastal and spectrum-sensitive applications. Expertly crafted from durable brass, copper, or aluminum, Kaidan is designed for seamless integration into steps and walls and fits into any standard single-gang junction box. Available in five finishes, it offers a sleek and versatile lighting solution for both residential and commercial settings.



BRONZE



HAND-RUBBED ANTIQUE BRASS



NATURAL COPPER



MATTE WHITE



NIGHTSHADE BLACK

SPECIFICATIONS

DIMENSIONS

Fixture Height	3" / 76 mm
Fixture Width	5" / 127 mm

MATERIAL

Material	Brass, Copper, or Aluminum**
Finish	Bronze, Hand-Rubbed Antique Brass, Matte White, Natural Copper, or Nightshade Black
Weight	1 lb

LAMPING

Lamp Type	Integrated LED
Lumens	42
Watts	3.3W
Voltage	12V
Lead Wire	18 AWG, 36"
Dimming	MLV
CCT	Turtle (Amber 585-600nm)
Field Serviceable LED	No
Operating Temperature	-30°C min -40°C max
LED Lifetime	50,000 Hours

WARRANTY

Lifetime warranty on manufacturer defects in the construction, but normal warranty applies for bulbs, integrated LEDs and living finishes.

**Aluminum construction is used for Matte White and Nightshade Black Fixtures.

DIMENSIONS

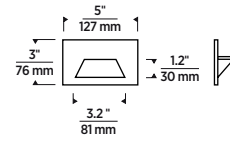

ORDERING INFORMATION

PRODUCT	FINISH	LAMP
SL6103 K Aidan Hex Aperture 12V Step Light	BZ BRONZE HAB HAND-RUBBED ANTIQUE BRASS MW MATTE WHITE* NC NATURAL COPPER B NIGHTSHADE BLACK*	T1 INTEGRATED LED 3.3W TURTLE (AMBER 585-600NM)

*Nightshade Black and Matte White damp rated for indoor use.



Kaidan Hex Aperture

120V STEP LIGHT

DESIGNER: SEAN LAVIN

The Kaidan Hex Aperture 120V Step Light features a concealed light source that delivers a uniform, downward illumination—enhancing safety along stairways, pathways, and wall perimeters. Its hexagonal faceplate ensures low-glare illumination while providing optimal visual comfort. Designed to fit into any standard single-gang junction box, it is installed cleanly into masonry or architectural wall surfaces. Constructed from durable brass, copper, or aluminum, Kaidan is available in five finish options. The integrated 2700K LED module light engine offers an ideal solution for residential and commercial step lighting applications.

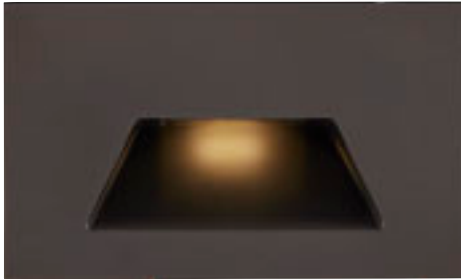

BRONZE



HAND-RUBBED ANTIQUE BRASS



NATURAL COPPER



MATTE WHITE



NIGHTSHADE BLACK

SPECIFICATIONS

DIMENSIONS

Fixture Height	3" / 76 mm
Fixture Width	5" / 127 mm

MATERIAL

Material	Brass, Copper, or Aluminum**
Finish	Bronze, Hand-Rubbed Antique Brass, Matte White, Natural Copper, or Nightshade Black
Weight	1 lb

LAMPING

Lamp Type	Integrated LED
Lumens	114
Watts	3.7W
Voltage	120V
Lead Wire	18 AWG, 36"
Dimming	ELV, TRIAC
CCT	2700K
Color Quality	90 CRI
Color Binning	3 Step
Field Serviceable LED	No
Operating Temperature	-30°C min -40°C max
LED Lifetime	50,000 Hours

WARRANTY

Lifetime warranty on manufacturer defects in the construction, but normal warranty applies for bulbs, integrated LEDs and living finishes.

**Aluminum construction is used for Matte White and Nightshade Black Fixtures.

DIMENSIONS

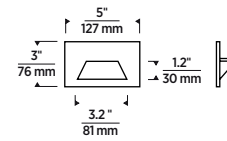

ORDERING INFORMATION

PRODUCT	FINISH	LAMP
SL657 K Aidan Hex Aperture 120V Step Light	BZ BRONZE HAB HAND-RUBBED ANTIQUE BRASS MW MATTE WHITE* NC NATURAL COPPER B NIGHTSHADE BLACK*	L1 INTEGRATED LED 3.7W 90 CRI 2700K

*Nightshade Black and Matte White damp rated for indoor use.



Kaidan Round Aperture

12V STEP LIGHT

DESIGNER: SEAN LAVIN

The Kaidan Round Aperture 12V Step Light features a half-circle cut-out faceplate that provides gentle, downward illumination to enhance safety and ambiance in outdoor environments. The integrated amber LED light engine provides an ideal solution for coastal and spectrum-sensitive applications. Expertly crafted from durable brass, copper, or aluminum, Kaidan is designed for seamless integration into steps and walls and fits into any standard single-gang junction box. Available in five finishes, it offers a sleek and versatile lighting solution for both residential and commercial settings.



BRONZE



HAND-RUBBED ANTIQUE BRASS



NATURAL COPPER

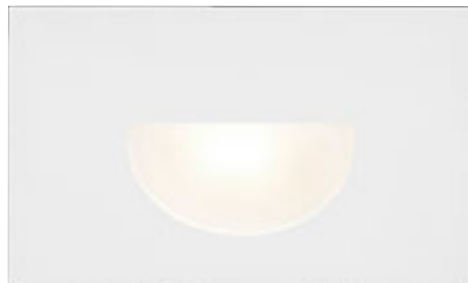

MATTE WHITE



NIGHTSHADE BLACK

SPECIFICATIONS

DIMENSIONS

Fixture Height	3" / 76 mm
Fixture Width	5" / 127 mm

MATERIAL

Material	Brass, Copper, or Aluminum**
Finish	Bronze, Hand-Rubbed Antique Brass, Matte White, Natural Copper, or Nightshade Black
Weight	1 lb

LAMPING

Lamp Type	Integrated LED
Lumens	42
Watts	3.3W
Voltage	12V
Lead Wire	18 AWG, 36"
Dimming	MLV
CCT	Turtle (Amber 585-600nm)
Field Serviceable LED	No
Operating Temperature	-30°C min -40°C max
LED Lifetime	50,000 Hours

WARRANTY

Lifetime warranty on manufacturer defects in the construction, but normal warranty applies for bulbs, integrated LEDs and living finishes.

**Aluminum construction is used for Matte White and Nightshade Black Fixtures.

DIMENSIONS

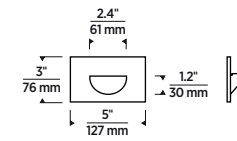

ORDERING INFORMATION

PRODUCT	FINISH	LAMP
SL6102 KAIDAN ROUND APERTURE 12V STEP LIGHT	BZ BRONZE HAB HAND-RUBBED ANTIQUE BRASS MW MATTE WHITE* NC NATURAL COPPER B NIGHTSHADE BLACK*	T1 INTEGRATED LED 3.3W TURTLE (AMBER 585-600NM)

*Nightshade Black and Matte White damp rated for indoor use.



Kaidan Round Aperture

120V STEP LIGHT

DESIGNER: SEAN LAVIN

The Kaidan Round Aperture 120V Step Light features a half-circle cut-out faceplate that delivers a uniform, downward illumination—enhancing safety along stairways, pathways, and wall perimeters. Designed to fit into any standard single-gang junction box, it is installed cleanly into masonry or architectural wall surfaces. Constructed from durable brass, copper, or aluminum, Kaidan is available in five finish options. The integrated 2700K LED light engine offers an ideal solution for residential and commercial step lighting applications.



BRONZE



HAND-RUBBED ANTIQUE BRASS

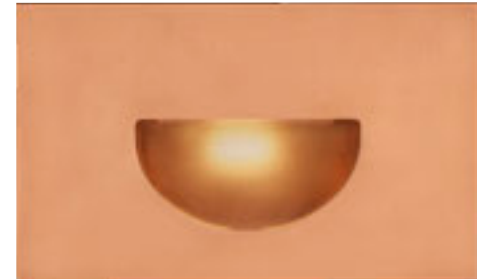

NATURAL COPPER

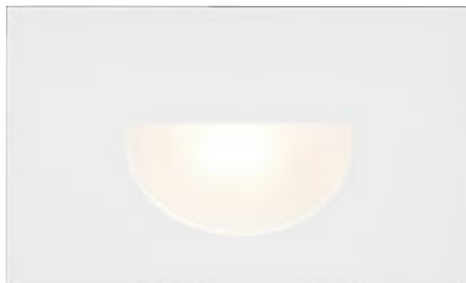

MATTE WHITE



NIGHTSHADE BLACK

SPECIFICATIONS

DIMENSIONS

Fixture Height	3" / 76 mm
Fixture Width	5" / 127 mm

MATERIAL

Material	Brass, Copper, or Aluminum**
Finish	Bronze, Hand-Rubbed Antique Brass, Matte White, Natural Copper, or Nightshade Black
Weight	1 lb

LAMPING

Lamp Type	Integrated LED
Lumens	114
Watts	3.7W
Voltage	120V
Lead Wire	18 AWG, 36"
Dimming	ELV, TRIAC
CCT	2700K
Color Quality	90 CRI
Color Binning	3 Step
Field Serviceable LED	No
Operating Temperature	-30°C min -40°C max
LED Lifetime	50,000 Hours

WARRANTY

Lifetime warranty on manufacturer defects in the construction, but normal warranty applies for bulbs, integrated LEDs and living finishes.

**Aluminum construction is used for Matte White and Nightshade Black Fixtures.

DIMENSIONS

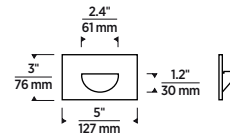

ORDERING INFORMATION

PRODUCT	FINISH	LAMP
SL656 K Aidan Round Aperture 120V Step Light	BZ BRONZE	L1 INTEGRATED LED 3.7W 90 CRI 2700K
	HAB HAND-RUBBED ANTIQUE BRASS	
	MW MATTE WHITE*	
	NC NATURAL COPPER	
	B NIGHTSHADE BLACK*	

*Nightshade Black and Matte White damp rated for indoor use.



Kaidan Triangle Aperture

12V STEP LIGHT

DESIGNER: SEAN LAVIN

The Kaidan Triangle Aperture 12V Step Light features a triangular cut-out faceplate that provides gentle, downward illumination to enhance safety and ambiance in outdoor environments. The integrated amber LED light engine provides an ideal solution for coastal and spectrum-sensitive applications. Expertly crafted from durable brass, copper, or aluminum, Kaidan is designed for seamless integration into steps and walls and fits into any standard single-gang junction box. Available in five finishes, it offers a sleek and versatile lighting solution for both residential and commercial settings.



BRONZE



HAND-RUBBED ANTIQUE BRASS



NATURAL COPPER



MATTE WHITE



NIGHTSHADE BLACK

SPECIFICATIONS

DIMENSIONS	
Fixture Height	3" / 76 mm
Fixture Width	5" / 127 mm
MATERIAL	
Material	Brass, Copper, or Aluminum**
Finish	Bronze, Hand-Rubbed Antique Brass, Matte White, Natural Copper, or Nightshade Black
Weight	1 lb
LAMPING	
Lamp Type	Integrated LED
Lumens	42
Watts	3.3W
Voltage	12V
Lead Wire	18 AWG, 36"
Dimming	MLV
CCT	Turtle (Amber 585-600nm)
Field Serviceable LED	No
Operating Temperature	-30°C min -40°C max
LED Lifetime	50,000 Hours
WARRANTY	
Lifetime warranty on manufacturer defects in the construction, but normal warranty applies for bulbs, integrated LEDs and living finishes.	

**Aluminum construction is used for Matte White and Nightshade Black Fixtures.

DIMENSIONS

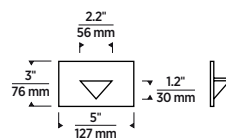

ORDERING INFORMATION

PRODUCT	FINISH	LAMP
SL6104 KAIDAN TRIANGLE APERTURE 12V STEP LIGHT	BZ BRONZE	T1 INTEGRATED LED 3.3W TURTLE (AMBER 585-600NM)
	HAB HAND-RUBBED ANTIQUE BRASS	
	MW MATTE WHITE*	
	NC NATURAL COPPER	
	B NIGHTSHADE BLACK*	

*Nightshade Black and Matte White damp rated for indoor use.



Kaidan Triangle Aperture

120V STEP LIGHT

DESIGNER: SEAN LAVIN

The Kaidan Triangle Aperture 120V Step Light features a triangular cut-out faceplate that delivers a uniform, downward illumination—enhancing safety along stairways, pathways, and wall perimeters. Designed to fit into any standard single-gang junction box, it is installed cleanly into masonry or architectural wall surfaces. Constructed from durable brass, copper, or aluminum, Kaidan is available in five finish options. The integrated 2700K LED module light engine offers an ideal solution for residential and commercial step lighting applications.



BRONZE



HAND-RUBBED ANTIQUE BRASS

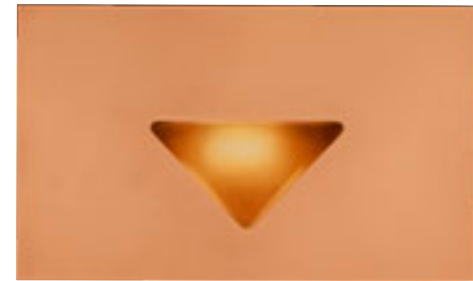

NATURAL COPPER



MATTE WHITE



NIGHTSHADE BLACK

SPECIFICATIONS

DIMENSIONS

Fixture Height	3" / 76 mm
Fixture Width	5" / 127 mm

MATERIAL

Material	Brass, Copper, or Aluminum**
Finish	Bronze, Hand-Rubbed Antique Brass, Matte White, Natural Copper, or Nightshade Black
Weight	1 lb

LAMPING

Lamp Type	Integrated LED
Lumens	114
Watts	3.7W
Voltage	120V
Lead Wire	18 AWG, 36"
Dimming	ELV, TRIAC
CCT	2700K
Color Quality	90 CRI
Color Binning	3 Step
Field Serviceable LED	No
Operating Temperature	-30°C min -40°C max
LED Lifetime	50,000 Hours

WARRANTY

Lifetime warranty on manufacturer defects in the construction, but normal warranty applies for bulbs, integrated LEDs and living finishes.

**Aluminum construction is used for Matte White and Nightshade Black Fixtures.

DIMENSIONS

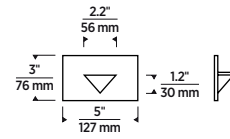

ORDERING INFORMATION

PRODUCT	FINISH	LAMP
SL658 K Aidan Triangle Aperture 120V Step Light	BZ BRONZE	L1 INTEGRATED LED 3.7W 90 CRI 2700K
	HAB HAND-RUBBED ANTIQUE BRASS	
	MW MATTE WHITE*	
	NC NATURAL COPPER	
	B NIGHTSHADE BLACK*	

*Nightshade Black and Matte White damp rated for indoor use.



WALL & POST MOUNT LIGHTING



Sentinel Shallow

SURFACE MOUNT

DESIGNER: SEAN LAVIN

The Sentinel Shallow Wall/Post Mount is designed to complement the Sentinel Pathway Lights, offering a coordinated lighting solution for vertical surfaces such as walls and posts. Its clean, low-profile form matches the path light's rounded silhouette, maintaining visual consistency across the landscape. Engineered for secure surface installation with a canopy that can cover standard round junction box, it delivers soft, controlled illumination that enhances architectural features while minimizing glare. Built for durability and available in matching finishes, it provides a compact, functional lighting solution.



BRONZE



HAND-RUBBED ANTIQUE BRASS



NATURAL COPPER

SPECIFICATIONS

DIMENSIONS

Fixture Height	4.2" / 107 mm
Fixture Diameter	4.8" / 122 mm

MATERIAL

Material	Brass or Copper
Finish	Bronze, Hand-Rubbed Antique Brass or Natural Copper
Weight	3.7 lbs

SOCKET

Assembly	Ceramic with spring-reinforced electrical connection
----------	--

LAMPING

Lamp Type	G4 LED (Sold Separately)
Lumens	150, 550
Watts	1.5W, 5W
Voltage	120V
Lead Wire	18 AWG, 8"
Dimming	ELV
CCT	2700K
Color Quality	90 CRI
Color Binning	3 Step
Field Serviceable LED	Yes
Operating Temperature	-30°C min -40°C max
LED Lifetime	25,000 Hours

WARRANTY

Lifetime warranty on manufacturer defects in the construction, but normal warranty applies for bulbs, integrated LEDs and living finishes.

DIMENSIONS

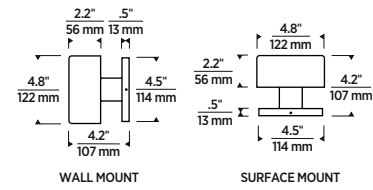

ORDERING INFORMATION

PRODUCT	FINISH	LAMPING
SL653 SENTINEL SHALLOW SURFACE MOUNT	BZ BRONZE	NB NO LAMP
	HAB HAND-RUBBED ANTIQUE BRASS	B1 LED LAMP G4 1.5W 90 CRI 2700K
	NC NATURAL COPPER	B2 LED LAMP G4 5W 90 CRI 2700K



Sentinel Deep

SURFACE MOUNT

DESIGNER: SEAN LAVIN

The Sentinel Deep Wall/Post Mount is designed to pair with the Sentinel Pathway Lights, offering a taller profile for added presence on walls and vertical surfaces. Its rounded form mirrors the path light's silhouette, maintaining a cohesive aesthetic throughout the landscape. Engineered for secure surface installation with a canopy that can cover standard round junction box, it delivers soft, downward illumination that enhances architectural elements while reducing glare. Durable and available in matching finishes, it provides a refined and functional lighting solution for outdoor environments.



BRONZE



HAND-RUBBED ANTIQUE BRASS



NATURAL COPPER

SPECIFICATIONS

DIMENSIONS

Fixture Height	5.2" / 132 mm
Fixture Diameter	4.8" / 122 mm

MATERIAL

Material	Brass or Copper
Finish	Bronze, Hand-Rubbed Antique Brass or Natural Copper
Weight	4.4 lbs

SOCKET

Assembly	Ceramic with spring-reinforced electrical connection
----------	--

LAMPING

Lamp Type	G4 LED (Sold Separately)
Lumens	150, 550
Watts	1.5W, 5W
Voltage	120V
Lead Wire	18 AWG, 8"
Dimming	ELV
CCT	2700K
Color Quality	90 CRI
Color Binning	3 Step
Field Serviceable LED	Yes
Operating Temperature	-30°C min -40°C max
LED Lifetime	25,000 Hours

WARRANTY

Lifetime warranty on manufacturer defects in the construction, but normal warranty applies for bulbs, integrated LEDs and living finishes.

DIMENSIONS

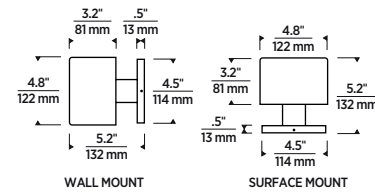

ORDERING INFORMATION

PRODUCT	FINISH	LAMP
SL652 SENTINEL DEEP SURFACE MOUNT	BZ BRONZE	NB NO LAMP
	HAB HAND-RUBBED ANTIQUE BRASS	B1 LED LAMP G4 1.5W 90 CRI 2700K
	NC NATURAL COPPER	B2 LED LAMP G4 5W 90 CRI 2700K



Balsam

SURFACE MOUNT

DESIGNER: SEAN LAVIN

The Balsam Wall/Post Mount is designed to complement the Balsam Pathway Light, creating a cohesive outdoor lighting solution. Its shade features soft corners that transition seamlessly into straight lines, matching the pathway version for a unified look. Engineered for secure surface installation with a canopy that can cover standard round junction box, it directs light downward or back at a wall to minimize glare while effectively illuminating walls and posts. Built for durability and available in three finishes, it provides functional and visually integrated lighting for outdoor spaces.



BRONZE



HAND-RUBBED ANTIQUE BRASS



NATURAL COPPER

SPECIFICATIONS

DIMENSIONS

Fixture Height	5.4" / 137 mm
Fixture Diameter	4.8" / 122 mm

MATERIAL

Material	Brass or Copper
Finish	Bronze, Hand-Rubbed Antique Brass or Natural Copper
Weight	3.9 lbs

LAMPING

Lamp Type	G4 LED (Sold Separately)
Lumens	150, 550
Watts	1.5W, 5W
Voltage	120V
Lead Wire	18 AWG, 8"
Dimming	ELV
CCT	2700K
Color Quality	90 CRI
Color Binning	3 Step
Field Serviceable LED	Yes
Operating Temperature	-30°C min -40°C max
LED Lifetime	25,000 Hours

WARRANTY

Lifetime warranty on manufacturer defects in the construction, but normal warranty applies for bulbs, integrated LEDs and living finishes.

DIMENSIONS

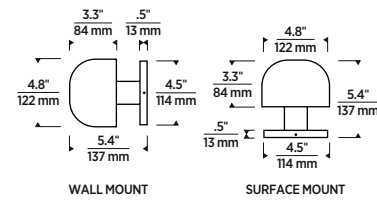

ORDERING INFORMATION

PRODUCT	FINISH	LAMP
SL651 BALSAM SURFACE MOUNT	BZ BRONZE	NB NO LAMP
	HAB HAND-RUBBED ANTIQUE BRASS	B1 LED LAMP G4 1.5W 90 CRI 2700K
	NC NATURAL COPPER	B2 LED LAMP G4 5W 90 CRI 2700K



Plateau Wide

SURFACE MOUNT

DESIGNER: SEAN LAVIN

The Plateau Wide Wall/Post Mount is designed to complement the Plateau Pathway Light, offering a cohesive solution for illuminating walls, posts, and other vertical surfaces. Its dome-shaped shade mirrors the path light's organic form, creating visual continuity across the landscape. Engineered for secure surface installation with a canopy that can cover standard round junction box, it delivers soft, wide illumination ideal for enhancing architectural elements. Constructed for durability and available in matching finishes, it blends form and function in a streamlined outdoor lighting solution.



BRONZE



HAND-RUBBED ANTIQUE BRASS



NATURAL COPPER

SPECIFICATIONS

DIMENSIONS

Fixture Height	4" / 102 mm
Fixture Diameter	7.8" / 198 mm

MATERIAL

Material	Brass or Copper
Finish	Bronze, Hand-Rubbed Antique Brass or Natural Copper
Weight	3.4 lbs

SOCKET

Assembly	Ceramic with spring-reinforced electrical connection
----------	--

LAMPING

Lamp Type	G4 LED (Sold Separately)
Lumens	150, 550
Watts	1.5W, 5W
Voltage	120V
Lead Wire	18 AWG, 8"
Dimming	ELV
CCT	2700K
Color Quality	90 CRI
Color Binning	3 Step
Field Serviceable LED	Yes
Operating Temperature	-30°C min -40°C max
LED Lifetime	25,000 Hours

WARRANTY

Lifetime warranty on manufacturer defects in the construction, but normal warranty applies for bulbs, integrated LEDs and living finishes.

DIMENSIONS

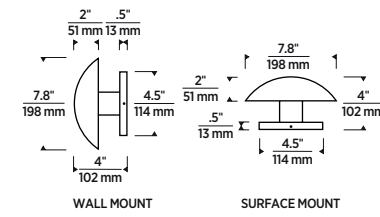

ORDERING INFORMATION

PRODUCT	FINISH	LAMP
SL654 PLATEAU WIDE SURFACE MOUNT	BZ BRONZE	NB NO LAMP
	HAB HAND-RUBBED ANTIQUE BRASS	B1 LED LAMP G4 1.5W 90 CRI 2700K
	NC NATURAL COPPER	B2 LED LAMP G4 5W 90 CRI 2700K



FLUSH MOUNT LIGHTING



Maxson

SQUARE FLUSH MOUNT

DESIGNER: SEAN LAVIN

The Maxson Square Flush Mount features a compact, geometric form with a recessed light source coupled with hex louver to minimize glare and enhance visual comfort. Its crisp lines and low-profile design integrate seamlessly into ceilings, soffits, or overhangs—delivering functional downlighting with a clean architectural presence. Available in three finished options and built for durability, Maxson Square offers a modern, versatile solution for exterior or transitional spaces.



BRONZE



HAND-RUBBED ANTIQUE BRASS

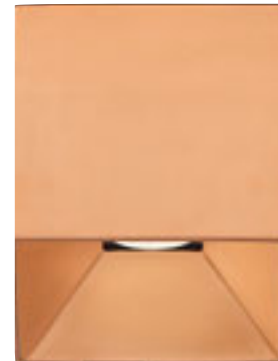

NATURAL COPPER

SPECIFICATIONS

DIMENSIONS

Fixture Height	4.7" / 119 mm
Fixture Diameter	4.7" / 119 mm

MATERIAL

Material	Brass or Copper
Finish	Bronze, Hand-Rubbed Antique Brass or Natural Copper
Weight	4.6 lbs

SOCKET

Assembly	Ceramic with spring-reinforced electrical connection
----------	--

LAMPING

Lamp Type	MR16 LED (Sold Separately)
Lumens	495, 507
Watts	5W
Voltage	120V
Lead Wire	18 AWG, 8"
Dimming	ELV
CCT	2700K
Color Quality	90 CRI
Color Binning	3 Step
Field Serviceable LED	Yes
Operating Temperature	-30°C min -40°C max
LED Lifetime	36,000 Hours

OPTIONS

Optical Controls	Hex Louver (Included)
------------------	-----------------------

WARRANTY

Lifetime warranty on manufacturer defects in the construction, but normal warranty applies for bulbs, integrated LEDs and living finishes.

DIMENSIONS

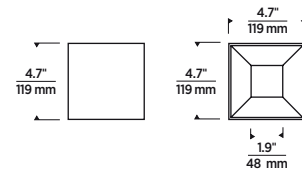

MOUNTING & ACCESSORIES

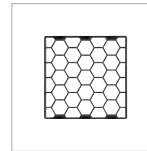

HEX LOUVER
(INCLUDED)

SL674

ORDERING INFORMATION

PRODUCT	FINISH	LAMPING
SL650 MAXSON SQUARE FLUSH MOUNT	BZ BRONZE	NB NO LAMP
	HAB HAND-RUBBED ANTIQUE BRASS	B3 LED LAMP MR16 5W 36° 90 CRI 2700K
	NC NATURAL COPPER	B4 LED LAMP MR16 5W 60° 90 CRI 2700K

HEX LOUVER INCLUDED.



Maxson

ROUND FLUSH MOUNT

DESIGNER: SEAN LAVIN

The Maxson Round Flush Mount features a compact, beveled design with a recessed light source coupled with hex louver to reduce glare and enhance visual comfort. Its low-profile, modern form integrates cleanly into ceilings and overhangs, delivering functional downlighting for a variety of architectural applications. Engineered for durability and available in three finish options, Maxson Round offers a sleek, versatile solution for exterior or transitional spaces.



BRONZE



HAND-RUBBED ANTIQUE BRASS



NATURAL COPPER

SPECIFICATIONS

DIMENSIONS

Fixture Height	4.7" / 119 mm
Fixture Diameter	4.7" / 119 mm

MATERIAL

Material	Brass or Copper
Finish	Bronze, Hand-Rubbed Antique Brass or Natural Copper
Weight	3.8 lbs

SOCKET

Assembly	Ceramic with spring-reinforced electrical connection
----------	--

LAMPING

Lamp Type	MR16 LED (Sold Separately)
Lumens	495, 507
Watts	5W
Voltage	120V
Lead Wire	18 AWG, 8"
Dimming	ELV
CCT	2700K
Color Quality	90 CRI
Color Binning	3 Step
Field Serviceable LED	Yes
Operating Temperature	-30°C min -40°C max
LED Lifetime	36,000 Hours

OPTIONS

Optical Controls	Hex Louver (Included)
------------------	-----------------------

WARRANTY

Lifetime warranty on manufacturer defects in the construction, but normal warranty applies for bulbs, integrated LEDs and living finishes.

DIMENSIONS

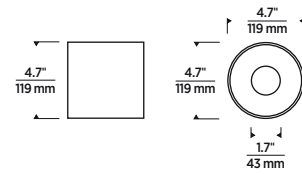

MOUNTING & ACCESSORIES

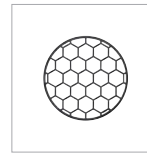

HEX LOUVER
(INCLUDED)

SL672

ORDERING INFORMATION

PRODUCT	FINISH	LAMPING
SL649 MAXSON ROUND FLUSH MOUNT	BZ BRONZE	NB NO LAMP
	HAB HAND-RUBBED ANTIQUE BRASS	B3 LED LAMP MR16 5W 36° 90 CRI 2700K
	NC NATURAL COPPER	B4 LED LAMP MR16 5W 60° 90 CRI 2700K

HEX LOUVER INCLUDED.



ACCESSORIES



1" Standard Riser & 2" Modern Riser

LANDSCAPE ACCESSORY

DESIGNER: SEAN LAVIN

1" STANDARD RISER

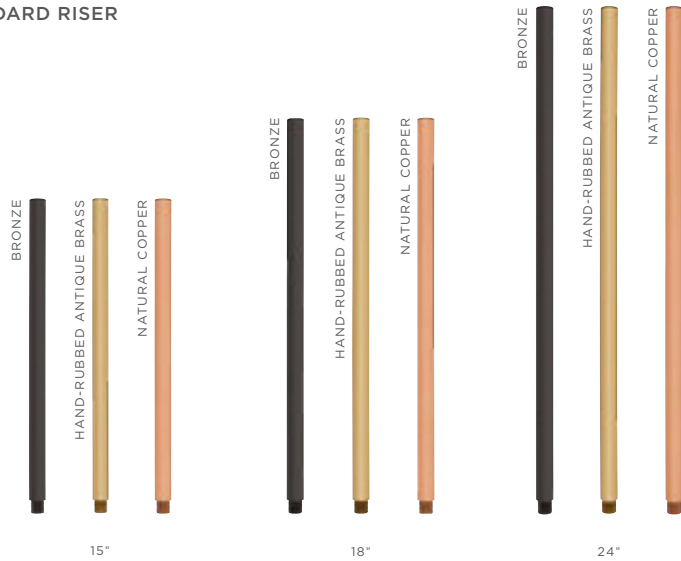

2" MODERN RISER



SPECIFICATIONS

DIMENSIONS	
Actual Height	18", 22", 28" / 457 mm, 559 mm, 711 mm 18", 22" / 457 mm, 559 mm
Actual Width	1", 1.9" / 25 mm, 48 mm
MATERIAL	
Material	Brass or Copper
Finish	Bronze, Hand-Rubbed Antique Brass, or Natural Copper
Weight	.8, .9, 1.1 lbs / 2.4, 2.7 lbs
WARRANTY	
	Lifetime warranty on manufacturer defects in the construction, but normal warranty applies for bulbs, integrated LEDs, and living finishes.

DIMENSIONS

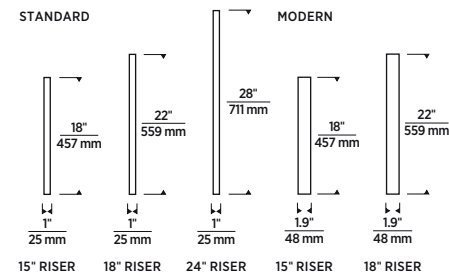

ORDERING INFORMATION

PRODUCT	RISER HEIGHT	FINISH
SL694 1" DIAMETER STANDARD RISER	R11 15" (1" DIA.)	BZ BRONZE
	R12 18" (1" DIA.)	HAB HAND-RUBBED ANTIQUE BRASS
	R13 24" (1" DIA.)	NATURAL COPPER
SL695 2" DIAMETER MODERN RISER	R21 15" (1.9" DIA.)	NC NATURAL COPPER
	R22 18" (1.9" DIA.)	

Heavy-Duty Stake

LANDSCAPE ACCESSORY

DESIGNER: SEAN LAVIN



SPECIFICATIONS

DIMENSIONS

Height 13" / 330 mm

Width 3.2" / 81 mm

MATERIAL

Material ABS Plastic with Solid Brass Threading

Weight .5 lbs

WARRANTY

Lifetime warranty on manufacturer defects in the construction, but normal warranty applies for bulbs, integrated LEDs, and living finishes.

DIMENSIONS

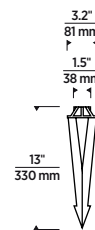

ORDERING INFORMATION

PRODUCT

SL659 13" HEAVY-DUTY GROUND STAKE

Trident Spike

LANDSCAPE ACCESSORY

DESIGNER: SEAN LAVIN

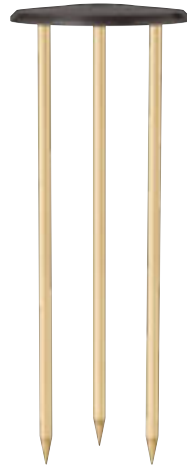

BRONZE



HAND-RUBBED ANTIQUE BRASS

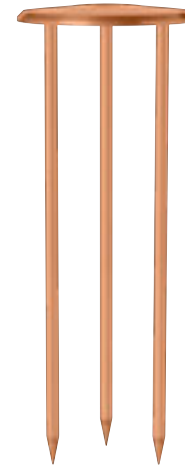

NATURAL COPPER

SPECIFICATIONS

DIMENSIONS	
Height	12.9" / 328 mm
Width	5" / 127 mm
MATERIAL	
Material	Brass or Copper
Weight	Bronze and Hand-Rubbed Antique Brass – 1.8 lbs Natural Copper – 2.2 lbs
WARRANTY	
	Lifetime warranty on manufacturer defects in the construction, but normal warranty applies for bulbs, integrated LEDs, and living finishes.

DIMENSIONS

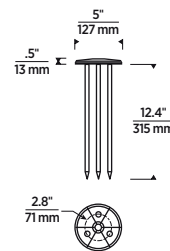

ORDERING INFORMATION

PRODUCT	FINISH
SL6122 12" TRIDENT SPIKE	BZ BRONZE
	HAB HAND-RUBBED ANTIQUE BRASS
	NC NATURAL COPPER

Arbor Tree Mount Screw-In

LANDSCAPE ACCESSORY

DESIGNER: SEAN LAVIN



BRONZE



HAND-RUBBED ANTIQUE BRASS



NATURAL COPPER

SPECIFICATIONS

DIMENSIONS	
Height	2.1" / 53 mm
Width	1.4" / 36 mm
MATERIAL	
Material	Brass and Stainless Steel or Copper and Stainless Steel
Finish	Bronze, Hand-Rubbed Antique Brass, or Natural Copper
Weight	.4 lbs
WARRANTY	
Lifetime warranty on manufacturer defects in the construction, but normal warranty applies for bulbs, integrated LEDs, and living finishes.	

DIMENSIONS

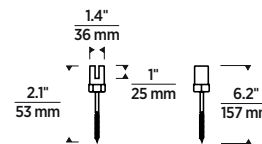

ORDERING INFORMATION

PRODUCT	FINISH
SL665 ARBOR TREE MOUNT SCREW-IN	BZ BRONZE
	HAB HAND-RUBBED ANTIQUE BRASS
	NC NATURAL COPPER

Arbor Tree & Surface Mount

LANDSCAPE ACCESSORY

DESIGNER: SEAN LAVIN



BRONZE



HAND-RUBBED ANTIQUE BRASS



NATURAL COPPER

SPECIFICATIONS

DIMENSIONS	
Height	1.1" / 28 mm
Width	6" / 152 mm
MATERIAL	
Material	Brass or Copper
Hardware	Brass and Stainless Steel or Copper and Stainless Steel
Finish	Bronze, Hand-Rubbed Antique Brass, or Natural Copper
Weight	.5 lbs
WARRANTY	
Lifetime warranty on manufacturer defects in the construction, but normal warranty applies for bulbs, integrated LEDs, and living finishes.	

DIMENSIONS

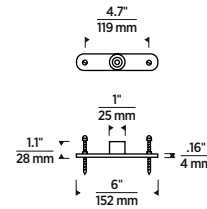

ORDERING INFORMATION

PRODUCT	FINISH
SL664 ARBOR TREE & SURFACE MOUNT	BZ BRONZE
	HAB HAND-RUBBED ANTIQUE BRASS
	NC NATURAL COPPER

Arbor Bungee Strap

LANDSCAPE ACCESSORY

DESIGNER: SEAN LAVIN



BRONZE



HAND-RUBBED ANTIQUE BRASS

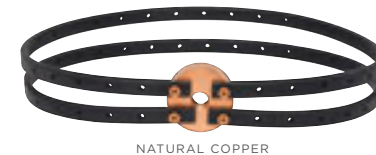

NATURAL COPPER

SPECIFICATIONS

DIMENSIONS	
Height	1" / 25 mm
Width	3" / 76 mm
MATERIAL	
Material	Brass or Copper
Hardware	Stainless Steel and Rubber
Finish	Bronze, Hand-Rubbed Antique Brass, or Natural Copper
Weight	1.9 lbs
WARRANTY	
Lifetime warranty on manufacturer defects in the construction, but normal warranty applies for bulbs, integrated LEDs, and living finishes.	

DIMENSIONS

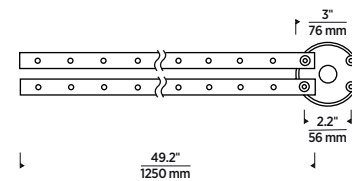

ORDERING INFORMATION

PRODUCT	FINISH
SL666 ARBOR BUNGEE STRAP	BZ BRONZE
	HAB HAND-RUBBED ANTIQUE BRASS
	NC NATURAL COPPER

Arbor Gutter Mount

LANDSCAPE ACCESSORY



SPECIFICATIONS

DIMENSIONS

Height	2.7" / 69 mm
Width	3.5" / 89 mm

MATERIAL

Material	Stainless Steel
Weight	.2 lbs

WARRANTY

Lifetime warranty on manufacturer defects in the construction, but normal warranty applies for bulbs, integrated LEDs, and living finishes..

DIMENSIONS

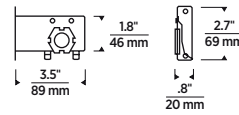

ORDERING INFORMATION

PRODUCT	FINISH
SL667 ARBOR GUTTER MOUNT	SS STAINLESS STEEL

Deck/Surface Mount

LANDSCAPE ACCESSORY

DESIGNER: SEAN LAVIN



BRONZE



HAND-RUBBED ANTIQUE BRASS



NATURAL COPPER

SPECIFICATIONS

DIMENSIONS	
Height	1" / 25 mm
Width	2.5" / 64 mm
MATERIAL	
Material	Brass or Copper
Hardware	Stainless Steel
Finish	Bronze, Hand-Rubbed Antique Brass, or Natural Copper
Weight	.6 lbs
WARRANTY	
Lifetime warranty on manufacturer defects in the construction, but normal warranty applies for bulbs, integrated LEDs, and living finishes.	

DIMENSIONS

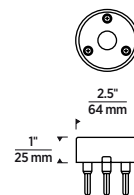

ORDERING INFORMATION

PRODUCT	FINISH
SL668 ARBOR DECK MOUNT	BZ BRONZE
	HAB HAND-RUBBED ANTIQUE BRASS
	NC NATURAL COPPER

Micro Spot Flange

LANDSCAPE ACCESSORY

DESIGNER: SEAN LAVIN



BRONZE



HAND-RUBBED ANTIQUE BRASS



NATURAL COPPER

SPECIFICATIONS

DIMENSIONS	
Height	1.1" / 28 mm
Width	2.4" / 61 mm
MATERIAL	
Material	Brass or Copper
Weight	.1 lbs
WARRANTY	
Lifetime warranty on manufacturer defects in the construction, but normal warranty applies for bulbs, integrated LEDs, and living finishes.	

DIMENSIONS

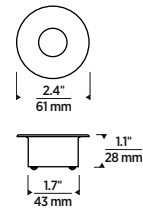

ORDERING INFORMATION

PRODUCT	FINISH
SL692 MICRO SPOT FLANGE	BZ BRONZE
	HAB HAND-RUBBED ANTIQUE BRASS
	NC NATURAL COPPER

Grass Shield

LANDSCAPE ACCESSORY

DESIGNER: SEAN LAVIN

SHAVER 11 GRASS SHIELD



BRONZE

HAND-RUBBED ANTIQUE BRASS

NATURAL COPPER

SHAVER 16 GRASS SHIELD



BRONZE

HAND-RUBBED ANTIQUE BRASS

NATURAL COPPER

SPECIFICATIONS

DIMENSIONS	
Inner Diameter	2.8" / 71 mm 3.5" / 89 mm
Outer Diameter	9.4" / 239 mm 9.8" / 250 mm
MATERIAL	
Material	Brass or Copper
Finish	Bronze, Hand-Rubbed Antique Brass, or Natural Copper
Weight	1.1 lbs / 1.4 lbs
WARRANTY	
	Lifetime warranty on manufacturer defects in the construction, but normal warranty applies for bulbs, integrated LEDs, and living finishes.

DIMENSIONS

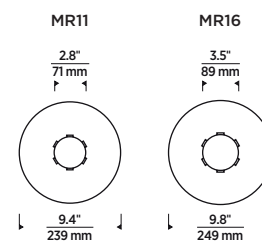

ORDERING INFORMATION

PRODUCT	FINISH
SL663 SHAVER 11 GRASS SHIELD*	BZ BRONZE
SL662 SHAVER 16 GRASS SHIELD**	HAB HAND-RUBBED ANTIQUE BRASS
	NC NATURAL COPPER

*FOR USE WITH SHAVER MR11 IN-GRADE LIGHTS.

**FOR USE WITH SHAVER MR16 IN-GRADE LIGHTS.

Concrete Pours

LANDSCAPE ACCESSORY

DESIGNER: SEAN LAVIN

SHAVER 11 CONCRETE POUR



SHAVER 16 CONCRETE POUR



SPECIFICATIONS

DIMENSIONS

Height	8.1" / 206 mm 8.6" / 218 mm
Width	3" / 76 mm 3.7" / 94 mm

MATERIAL

Material	ABS Plastic
Weight	.3 lbs

WARRANTY

Lifetime warranty on manufacturer defects in the construction, but normal warranty applies for bulbs, integrated LEDs, and living finishes.

DIMENSIONS

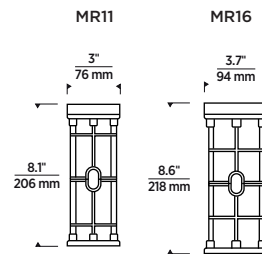

ORDERING INFORMATION

PRODUCT

- SL661 SHAVER 11 CONCRETE POUR
- SL660 SHAVER 16 CONCRETE POUR

Concrete Anchors

LANDSCAPE ACCESSORY



SPECIFICATIONS

DIMENSIONS	
Height	8.1" / 206 mm
Width	1.1" / 28 mm
MATERIAL	
Material	Hot Dip Galvanized Steel
Weight	.6 lb each
WARRANTY	
Lifetime warranty on manufacturer defects in the construction, but normal warranty applies for bulbs, integrated LEDs, and living finishes.	

DIMENSIONS

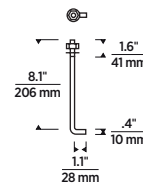

ORDERING INFORMATION

PRODUCT

SL689 CONCRETE ANCHORS, SET OF 3

5" & 12" Stainless Steel Spikes

LANDSCAPE ACCESSORY

DESIGNER: SEAN LAVIN

5" STAINLESS STEEL SPIKES



12" STAINLESS STEEL SPIKES



SPECIFICATIONS

DIMENSIONS	
Height	5" / 127 mm 12.6" / 320 mm
Width	.2" / 5 mm .4" / 10 mm
MATERIAL	
Material	Stainless Steel
Weight	.1 lbs & 1.5 lbs
WARRANTY	
	Lifetime warranty on manufacturer defects in the construction, but normal warranty applies for bulbs, integrated LEDs, and living finishes.

DIMENSIONS

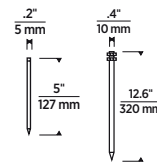

ORDERING INFORMATION

PRODUCT

SL690 5" STAINLESS STEEL SPIKES, SET OF 3

SL699 12" STAINLESS STEEL SPIKES, SET OF 3

Cut-Off Reflector

LANDSCAPE ACCESSORY

DESIGNER: SEAN LAVIN



SPECIFICATIONS

DIMENSIONS	
Height	1.6" / 41 mm
Width	2.1" / 53 mm
MATERIAL	
Material	Aluminum
Weight	.03 lbs
WARRANTY	
Lifetime warranty on manufacturer defects in the construction, but normal warranty applies for bulbs, integrated LEDs, and living finishes.	

DIMENSIONS

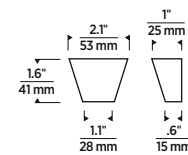

ORDERING INFORMATION

PRODUCT	FINISH
SL669 PATHWAY LIGHT REFLECTOR	AL ALUMINUM

Color Lenses

LANDSCAPE ACCESSORY

DESIGNER: SEAN LAVIN

MR11 LENSES



RED



GREEN



BLUE

MR16 LENSES



RED



GREEN



BLUE

SPECIFICATIONS

DIMENSIONS	
Diameter	MR11: 1.4" / 36 mm MR16: 2" / 51 mm
Width	MR11 .1" / 2.5 mm MR16 .1" / 2.5 mm
MATERIAL	
Material	Acrylic
Weight	.03 lbs
WARRANTY	
	Lifetime warranty on manufacturer defects in the construction, but normal warranty applies for bulbs, integrated LEDs, and living finishes.

DIMENSIONS

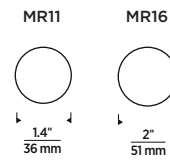

ORDERING INFORMATION

PRODUCT	FINISH
SL671 MR11 COLORED DIFFUSER	BL BLUE
SL670 MR16 COLORED DIFFUSER	GR GREEN
	RD RED

Lens Diffusers

LANDSCAPE ACCESSORY

DESIGNER: SEAN LAVIN

MR11 LENSES



DIFFUSER SPREAD LINEAR SPREAD SANDBLASTED SOLITE SOFT FOCUS

MR16 LENSES

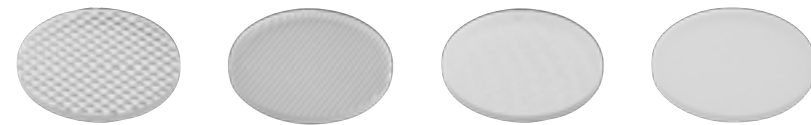

DIFFUSER SPREAD LINEAR SPREAD SANDBLASTED SOLITE SOFT FOCUS

SPECIFICATIONS

DIMENSIONS	
Diameter	MR11: 1.4" / 36 mm MR16: 2" / 51 mm
Width	MR11: .1" / 2.5 mm MR16: .1" / 2.5 mm
MATERIAL	
Material	Acrylic
Weight	.03 lbs
WARRANTY	
	Lifetime warranty on manufacturer defects in the construction, but normal warranty applies for bulbs, integrated LEDs, and living finishes.

DIMENSIONS

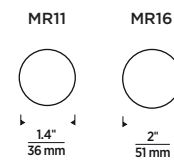

ORDERING INFORMATION

PRODUCT	FINISH
SL6106 MR11 LENS	DF DIFFUSER SPREAD LENS
SL6105 MR16 LENS	LL LINEAR SPREAD LENS
	SB SANDBLASTED LENS
	SF SOLITE SOFT FOCUS LENS

Hex Louvers

LANDSCAPE ACCESSORY

DESIGNER: SEAN LAVIN



SPECIFICATIONS

DIMENSIONS	
Diameter / Length	.9" / 23 mm 1.4" / 36 mm 1.7" / 43 mm 2" / 51 mm 2.2" / 56 mm 2.2" / 56 mm 3.4" / 86 mm
MATERIAL	
Material	ABS Plastic
Weight	.03 lbs
WARRANTY	
	Lifetime warranty on manufacturer defects in the construction, but normal warranty applies for bulbs, integrated LEDs, and living finishes.

DIMENSIONS

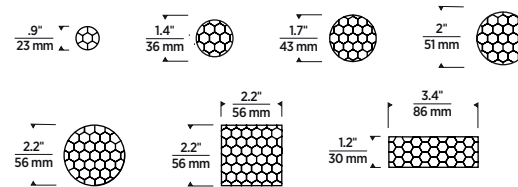

ORDERING INFORMATION

- PRODUCT**
- SL693** TULE HEX LOUVER
 - SL676** MR11 ROUND HEX LOUVER IN-GRADE
 - SL673** MR11 ROUND HEX LOUVER
 - SL675** MR16 ROUND HEX LOUVER IN-GRADE
 - SL672** MR16 ROUND HEX LOUVER
 - SL674** MR16 SQUARE HEX LOUVER
 - SL677** WALL WASH HEX LOUVER

Wall Wash Horizontal & Vertical Spread

LANDSCAPE ACCESSORY

DESIGNER: SEAN LAVIN

HORIZONTAL SPREAD



VERTICAL SPREAD



SPECIFICATIONS

DIMENSIONS	
Height	1.5" / 38 mm
Width	3.7" / 94 mm
MATERIAL	
Material	Acrylic
Weight	.1 lbs
WARRANTY	
Lifetime warranty on manufacturer defects in the construction, but normal warranty applies for bulbs, integrated LEDs, and living finishes.	

DIMENSIONS

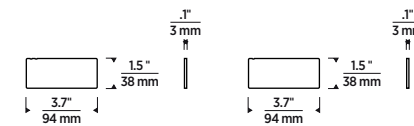

ORDERING INFORMATION

PRODUCT

SL678 WALL WASH HORIZONTAL SPREAD

SL679 WALL WASH VERTICAL SPREAD

10AWG & 14AWG Wire

LANDSCAPE ACCESSORY

10AWG WIRE



14AWG WIRE



SPECIFICATIONS

DIMENSIONS	
Gauge	10AWG or 14AWG
Length	250', 500', 1000'
MATERIAL	
Material	Copper and PVC
Weight	10AWG: 250' spool: 26 lbs; 500' spool: 52 lbs; 1000' spool: 104lbs 14AWG: 250' spool: 10.2 lbs; 500' spool: 20.4lbs; 1000' spool: 40.8lbs
WARRANTY	
	Lifetime warranty on manufacturer defects in the construction, but normal warranty applies for bulbs, integrated LEDs, and living finishes.

ORDERING INFORMATION

PRODUCT	LENGTH
SL684 10AWG WIRE	250 250'
SL685 14AWG WIRE	500 500'
	1000 1000'

150W & 300W Transformer

LANDSCAPE ACCESSORY

DESIGNER: SEAN LAVIN

SPECIFICATIONS

VOLTAGE	
Input Voltage	120V: 120V AC 50/60Hz
Output Voltage	120V: 12V AC
CURRENT	
Input Current	120V: 1.25A (150W) 120V: 2.5A (300W)
Output Current	150W: 12.5A 300W: 25A
OPTIONS	
Mounting Options	Wall (12" above finished grade)
Dimming	Magnetic Low Voltage
Efficiency*	>95%
Power Factor	>95%
Case TC	90°C max
Protection	Input/Output
Storage	-30°C/+90°C
Humidity	95% RH max
Wet Listed	IP65
WARRANTY**	
	5 Years

*As a general rule when using LED fixtures, we do not recommend using greater than 70% of specified maximum wattage on the transformer due to inrush current. For assistance, please contact our technical support department.

**Visit visualcomfort.com for specific warranty limitations and details.

ORDERING INFORMATION

PRODUCT	FINISH
SL680 150W OUTDOOR TRANSFORMER	SS STAINLESS STEEL
SL681 300W OUTDOOR TRANSFORMER	

150W



300W



DIMENSIONS

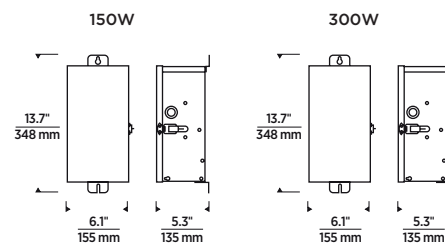

Direct Bury Splice Kit

LANDSCAPE ACCESSORY



SPECIFICATIONS

DIMENSIONS	
Height	3.7" / 94 mm
Width	1.5" / 38 mm 1.1" / 28 mm
MATERIAL	
Material	Impact and UV Resistant Polypropylene
Weight	.13 lbs
WARRANTY	
	Lifetime warranty on manufacturer defects in the construction, but normal warranty applies for bulbs, integrated LEDs, and living finishes.

DIMENSIONS

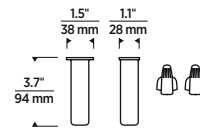

ORDERING INFORMATION

PRODUCT

SL686 DIRECT BURY SPLICE KIT

Intermatic Digital Astronomic Timer

LANDSCAPE ACCESSORY



SPECIFICATIONS

DIMENSIONS	
Height	3.2" / 81 mm
Width	3.3" / 84 mm
MATERIAL	
Material	Plastic
Weight	.4 lbs
WARRANTY	
	Lifetime warranty on manufacturer defects in the construction, but normal warranty applies for bulbs, integrated LEDs, and living finishes.

DIMENSIONS

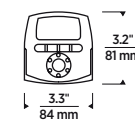

ORDERING INFORMATION

PRODUCT

SL683 INTERMATIC DIGITAL ASTRONOMIC TIMER

Photocell

LANDSCAPE ACCESSORY



SPECIFICATIONS

DIMENSIONS	
Height	3.4" / 86 mm
Width	2" / 51 mm
MATERIAL	
Material	Plastic
Weight	.2 lbs
WARRANTY	
Lifetime warranty on manufacturer defects in the construction, but normal warranty applies for bulbs, integrated LEDs, and living finishes.	

DIMENSIONS

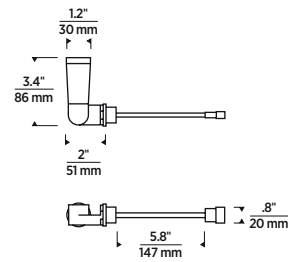

ORDERING INFORMATION

PRODUCT

SL682 PHOTOCCELL

MR11 LED 36° & 60°

LANDSCAPE ACCESSORY

MR11 LED 36°



SPECIFICATIONS

LAMPING	
Lumens	270
Voltage	12V
Wattage	3W
CRI	90
Color Temperature	2700K
Beam Angle	36°
WARRANTY	
Lifetime warranty on manufacturer defects in the construction, but normal warranty applies for bulbs, integrated LEDs, and living finishes.	

ORDERING INFORMATION

PRODUCT

300BLV604 MR11 LED 36°

MR11 LED 60°



SPECIFICATIONS

LAMPING	
Lumens	270
Voltage	12V
Wattage	3W
CRI	90
Color Temperature	2700K
Beam Angle	60°
WARRANTY	
Lifetime warranty on manufacturer defects in the construction, but normal warranty applies for bulbs, integrated LEDs, and living finishes.	

ORDERING INFORMATION

PRODUCT

300BLV605 MR11 LED 60°

MR16 LED 36° & 60°

LANDSCAPE ACCESSORY

MR16 LED 36°



MR16 LED 60°



SPECIFICATIONS

LAMPING	
Lumens	495
Voltage	12V
Wattage	5W
CRI	90
Color Temperature	2700K
Beam Angle	36°
WARRANTY	
Lifetime warranty on manufacturer defects in the construction, but normal warranty applies for bulbs, integrated LEDs, and living finishes.	

ORDERING INFORMATION

PRODUCT
300BLV602 MR16 LED 36°

SPECIFICATIONS

LAMPING	
Lumens	507
Voltage	12V
Wattage	5W
CRI	90
Color Temperature	2700K
Beam Angle	60°
WARRANTY	
Lifetime warranty on manufacturer defects in the construction, but normal warranty applies for bulbs, integrated LEDs, and living finishes.	

ORDERING INFORMATION

PRODUCT
300BLV603 MR16 LED 60°

G4 LED 1.5W & 5W

LANDSCAPE ACCESSORY

G4 LED 1.5W



SPECIFICATIONS

LAMPING	
Lumens	150
Watts	1.5W
Voltage	12V
CRI	90
Color Temperature	2700K
MATERIAL	
Ceramic and PC	
WARRANTY	Lifetime warranty on manufacturer defects in the construction, but normal warranty applies for bulbs, integrated LEDs, and living finishes.

ORDERING INFORMATION

PRODUCT

300BLV600 G4 LED 1.5W

G4 LED 5W



SPECIFICATIONS

LAMPING	
Lumens	550
Watts	5W
Voltage	12V
CRI	90
Color Temperature	2700K
MATERIAL	
Ceramic and PC	
WARRANTY	Lifetime warranty on manufacturer defects in the construction, but normal warranty applies for bulbs, integrated LEDs, and living finishes.

ORDERING INFORMATION

PRODUCT

300BLV601 G4 LED 5W



VISUAL COMFORT

SIGNATURE COLLECTION

MODERN COLLECTION

ARCHITECTURAL COLLECTION

LANDSCAPE COLLECTION

STUDIO COLLECTION

FAN COLLECTION

7400 Linder Avenue
Skokie, IL 60077

Phone: 800.969.3347

Fax: 866.490.7765

visualcomfort.com | @visualcomfort